

20 | 26

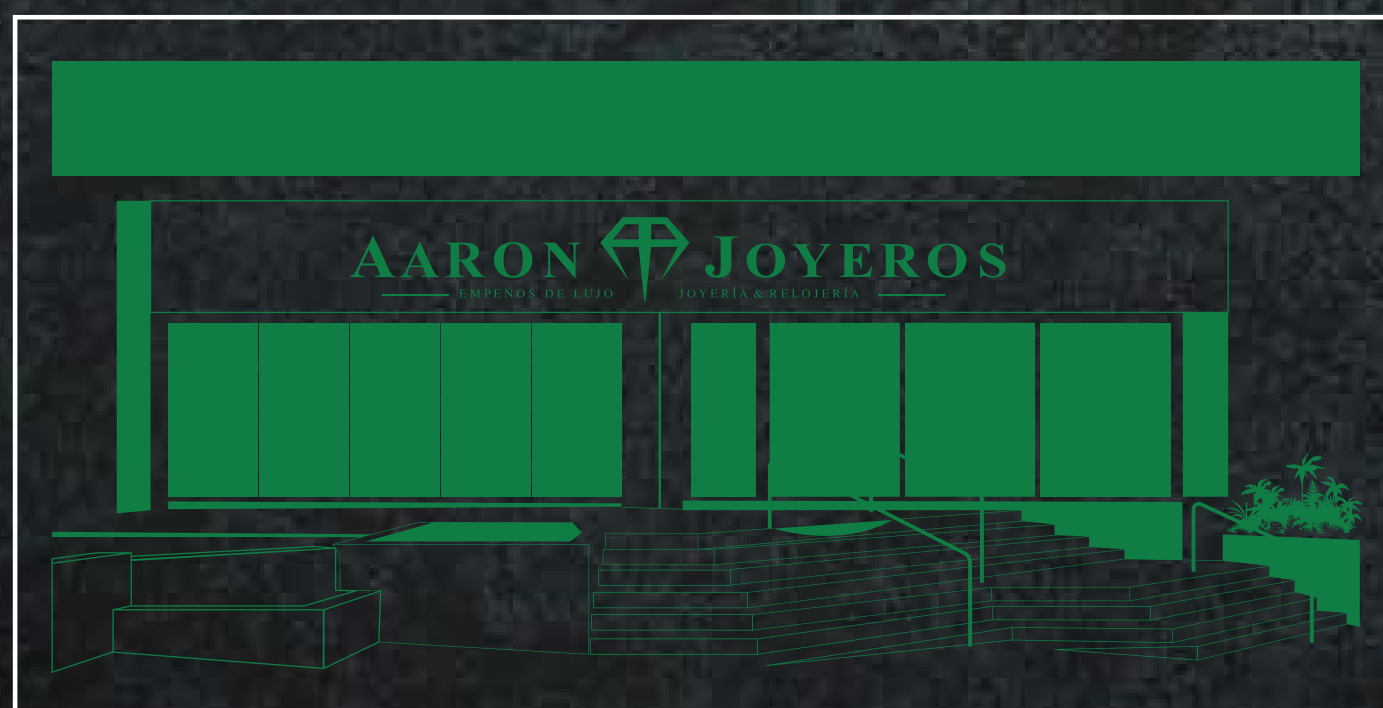

CATÁLOGO
INTERACTIVO

AARON  JOYEROS

ÍNDICE

Interactivo

BIENVENIDO A UNA EXPERIENCIA DE LUJO Y PRECISIÓN

Este catálogo interactivo ha sido diseñado para que explores nuestras colecciones de diamantes, bolígrafos y relojes de manera intuitiva y dinámica.

			
MANCUERNAS	DIAMANTES	BOLÍGRAFOS	RELOJES



Haz clic en cada categoría para descubrir piezas seleccionadas con los más altos estándares de calidad, autenticidad y distinción. Cada sección te permitirá navegar fácilmente entre detalles, especificaciones y opciones disponibles.

índice

CATÁLOGO TOUCH



INTERACTIVO

Toca la marca de tu preferencia para navegar por nuestras exclusivas selecciones

AP
AUDEMARS PIGUET
Le maître de l'horlogerie depuis 1875

CHAUMET
PARIS

GUCCI

PIAGET

Alain Silberstein®

Chopard
GENÈVE

HAMILTON

RW
RAYMOND WEIL
GENÈVE

AZIMUT

CONCORD

HARRY WINSTON

REVUE THOMMEN
Since 1853

BALL

CORUM

HUBLOT

ROGER DUBUIS

BAUME & MERCIER
MAISON D'HORLOGERIE GENÈVE 1830

DEVON

IWC
SCHAFFHAUSEN

ROLEX

BLANCPAIN

DUMOREAU

JAEGER-LECOULTRE

TAG Heuer
SWISS AVANT-GARDE SINCE 1860

Bell & Ross

EBEL

LONGINES

TIFFANY & CO.

BOUCHERON
PARIS

EBERHARD & CO

MONT
BLANC

TUDOR

Breguet
Depuis 1775

EDOX

MAURICE LACROIX
Manufacture Horlogère Suisse

U-BOAT

BREITLING
1884

FENDI

OMEGA

ULYSSE NARDIN
SINCE 1846 - La Locle - Suisse

BVLGARI

FREDERIQUE CONSTANT
GENÈVE

ORIS
HÖLSTEIN 1904

VACHERON CONSTANTIN
GENÈVE

Cartier

GIRARD-PERREGAUX

PANERAI

Van Cleef & Arpels

CHANEL

GRAHAM
LONDON

CHARRIOL
GENÈVE

Vintage

AARON JOYEROS

JOYERIA & RELOJERIA

CÓMO LLEGAR a nuestras Boutiques?

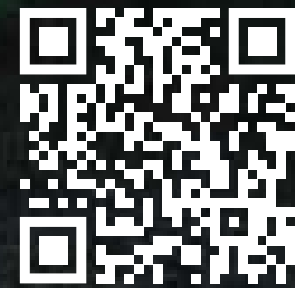

Boutique
OBARRIO

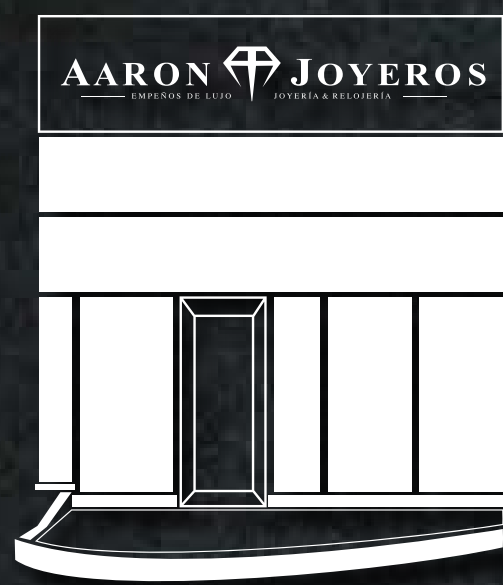

Boutique
COSTA DEL ESTE



Haz clic en el ícono para ir a **Google Maps**.

ACEPTAMOS

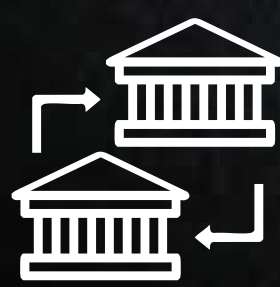

Transferencia
Bancaria



Tarjeta de
Crédito



Tarjeta
Clave

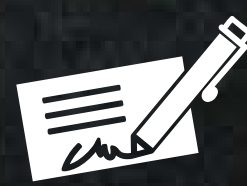

Cheques



6225-5554

Whatsapp



aronjoyerospty

Compramos y vendemos relojes y joyería 100% original.
NO SOMOS DISTRIBUIDOR AUTORIZADO.
Precios sujetos a cambios.

AARON JOYEROS
JOYERIA & RELOJERIA

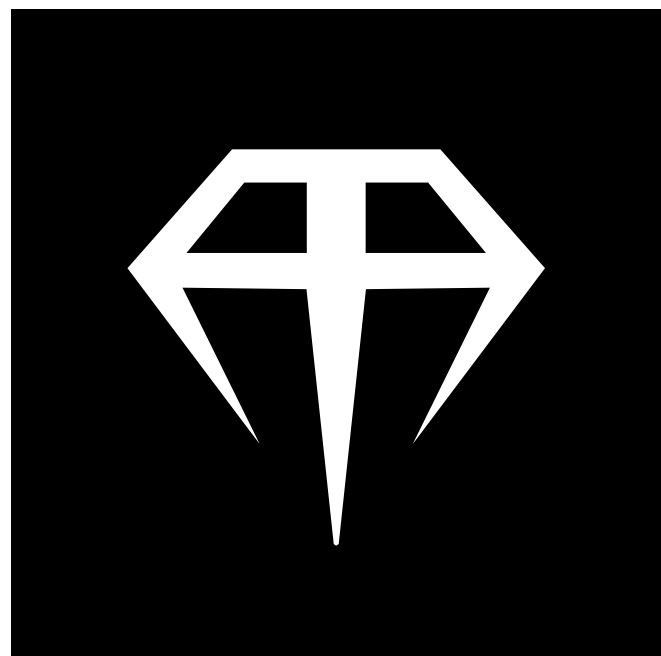

Mancuernas

01

Clásicos Atemporales

Siluetas pulidas y simétricas que celebran el buen vestir tradicional. La inversión definitiva en sutileza y distinción que nunca pasa de moda.

TIFFANY & Co.

ESPECIFICACIONES



Oro / 18 Quilates



OBARRIO

PRECIO \$2,420



ESPECIFICACIONES



Oro / 14 Quilates



OBARRIO

PRECIO \$3,100

ESPECIFICACIONES



Oro / 14 Quilates



OBARRIO

PRECIO \$3,000



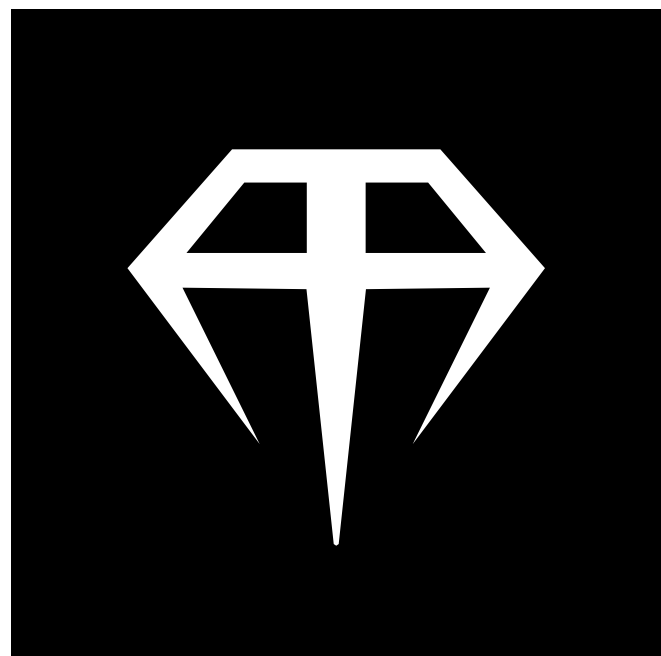

Mancuernas

02

Ingeniería de Precisión

Piezas que fusionan la micro-ingeniería con la alta joyería. Un homenaje al diseño estructural para quienes ven el detalle técnico como una forma de arte.



BREITLING
1884

ESPECIFICACIONES



Acero



OBARRIO

PRECIO



\$120

ESPECIFICACIONES



Oro Rosa / 18 Quilates



OBARRIO

PRECIO



\$3,000



Cartier

ESPECIFICACIONES



Acero



OBARRIO

PRECIO



\$500



Diamantes

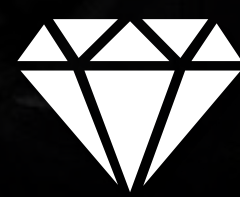

Presentamos una cuidada selección de diamantes elegidos bajo los más altos estándares de calidad, pureza y proporción. Cada piedra ha sido evaluada por su brillo, simetría y transparencia, garantizando una presencia que deslumbra a primera vista.

Nuestra colección equilibra corte, color, claridad y quilataje, asegurando no solo belleza excepcional, sino también valor y permanencia en el tiempo. Más que una muestra de gemas, es una invitación a invertir con criterio y crear piezas destinadas a trascender generaciones.

Aquí comienza su próxima gran elección.



DIAMANTES

01/02



REDONDO

CT | 1.06
COLOR | J/K
CLARIDAD | VS2

PRECIO 
\$4,150

OBARRIO



REDONDO

CT | 0.44
COLOR | K/L
CLARIDAD | SI1

PRECIO 
\$650

OBARRIO



REDONDO

CT | 0.22
COLOR |
CLARIDAD |

PRECIO 
\$2,000

OBARRIO



REDONDO

 **GIA** 
CT | 1.30
COLOR | L, FAINT BROWN
CLARIDAD | VVS2

PRECIO 
\$3,300

OBARRIO



REDONDO

CT | 1.20
COLOR |
CLARIDAD |

PRECIO 
\$3,800

OBARRIO



PRINCESS CUT

CT | 1.60
COLOR | H
CLARIDAD | i2

PRECIO 
\$5,000

OBARRIO



DIAMANTES

02/02



REDONDO

CT | 1.64
COLOR | G
CLARIDAD | VS2

PRECIO 
\$12,000

OBARRIO



RADIANT CUT



CT | 2.19
COLOR | F
CLARIDAD | vvs1

PRECIO 
\$22,000

OBARRIO



REDONDO

CT | 0.75
COLOR | J
CLARIDAD | VS1

PRECIO 
\$2,500

OBARRIO



REDONDO

CT | 1.735
COLOR | m
CLARIDAD | si1

PRECIO 
\$3,500

OBARRIO

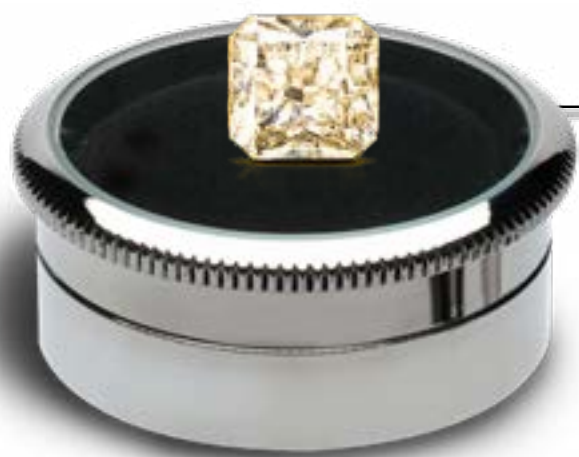

CUSION CUT

CT | 0.87
COLOR | fancy
CLARIDAD | yellow

PRECIO 
\$4,500

OBARRIO



PRINCESS CUT



CT | 2.13
COLOR | f
CLARIDAD | vs1

PRECIO 
\$19,800

COSTA DEL ESTE



BOLÍGRAFOS

Una colección creada para quienes ven la escritura como una **expresión de estilo y personalidad**. Cada pieza combina precisión, equilibrio y diseño refinado para ofrecer una experiencia superior en cada trazo.

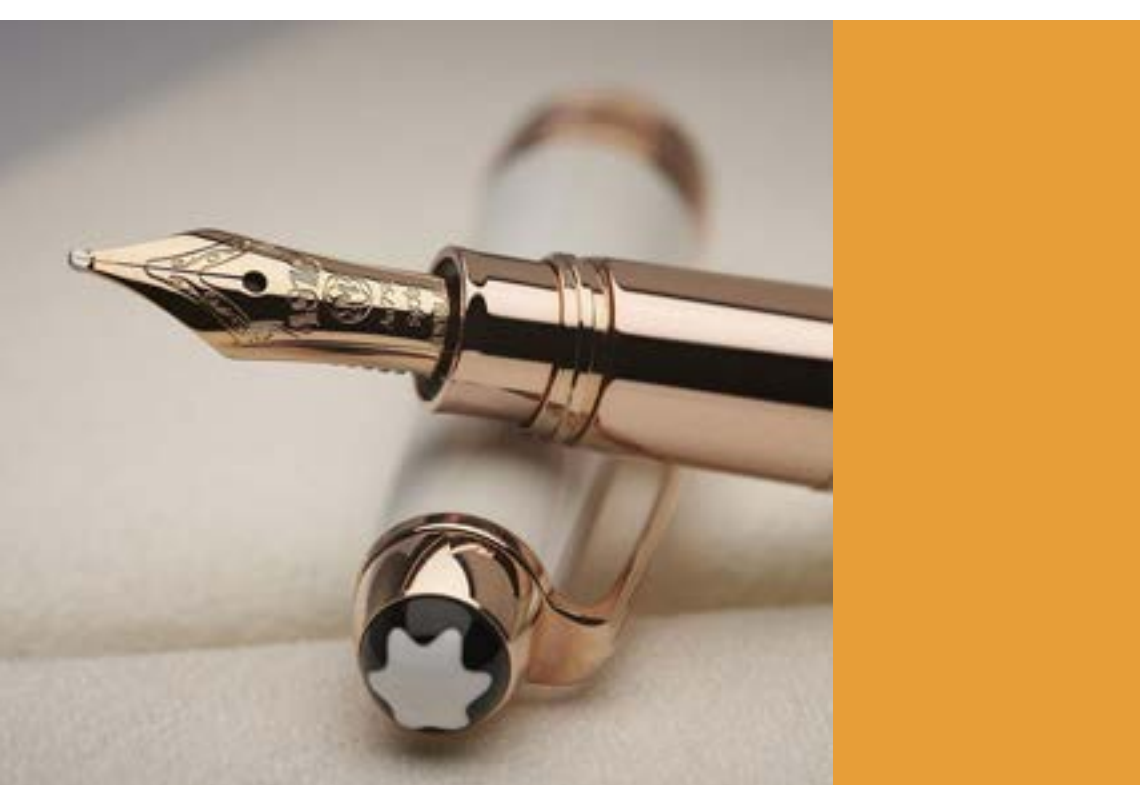

AARON  JOYEROS

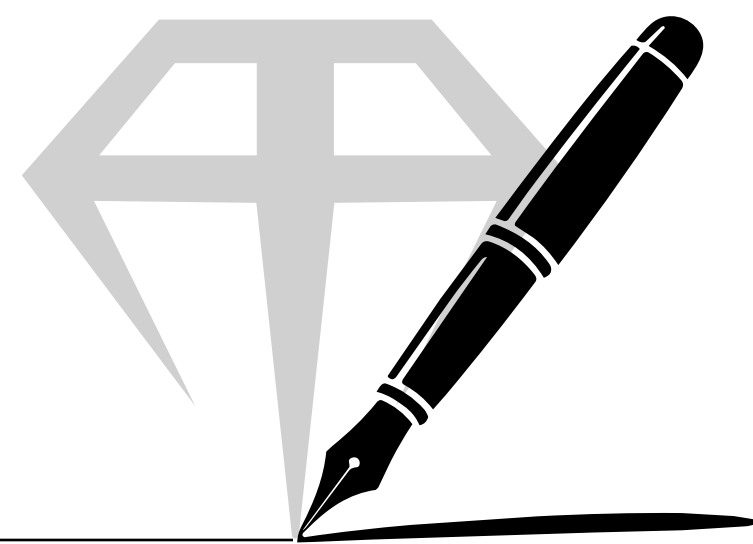

BOLÍGRAFOS

HOMENAJE A

ROBERT LOUIS STEVENSON



MONTBLANC

EDICIÓN LIMITADA



CAJA



PAPELES

Este exclusivo bolígrafo, inspirado en el espíritu aventurero y literario de Robert Louis Stevenson, combina elegancia clásica con detalles náuticos y artesanales. Su acabado en tonos dorados, grabados refinados y elementos inspirados en la exploración reflejan la esencia del autor de **La Isla del Tesoro**. Una pieza de colección que une escritura, historia y lujo en un diseño sofisticado y atemporal.

PRECIO 
\$5,700



OBARRIO

BOLÍGRAFOS



MONT
BLANC



JOHN LENNON

TIPO | ROLLERBALL

PRECIO 
\$1,400



JOHN LENNON

TIPO | FUENTE

PRECIO 
\$1,400



BOLÍGRAFOS

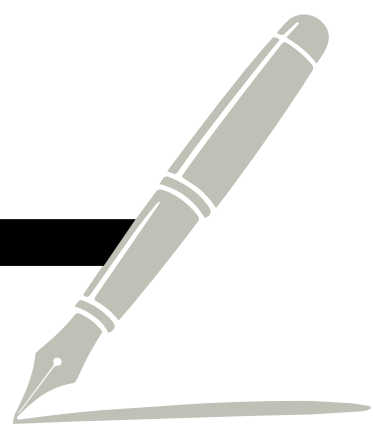

MONT
BLANC



MAHATMA GANDHI

TIPO | ESTILOGRÁFICA



PRECIO 
\$2,200



PRINCESSE

Grace de Mónaco

TIPO | ROLLERBALL

PRECIO 
\$600



MONT
BLANC



AARON  JOYEROS



BOLÍGRAFOS

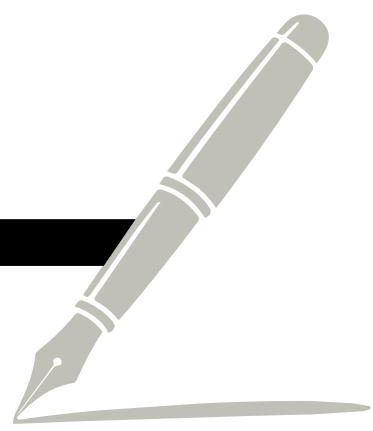

**MONT
BLANC**

HENRY E. STEINWAY

TIPO | ESTILOGRÁFICA



Mecenas del Arte
Steinway 4810

Esta pluma rinde homenaje a Henry E. Steinway, fundador de Steinway & Sons y revolucionario de la fabricación de pianos en el siglo XIX. Montblanc la incluyó en su colección Patron of Art, combinando inspiración musical con alta artesanía en escritura.

PRECIO 
\$3,000



CAJA



PAPELES



AARON  JOYEROS

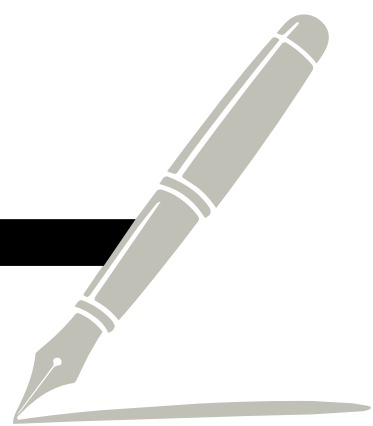

EDITION
LEO TOLSTOY

TIPO | BALLPOINT

PRECIO 
\$3,500



CAJA

MONT 
BLANC

EDITION
LEO TOLSTOY

TIPO | BALLPOINT

PRECIO 
\$2,600



PAPELES



EDITION
LEO TOLSTOY

EDICIÓN LIMITADA



BOLÍGRAFOS

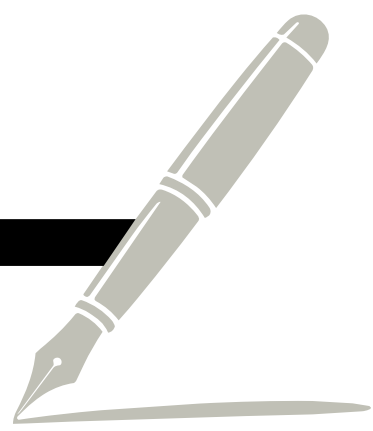

**MONT
BLANC** 

GEORGE BERNARD SHAW

TIPO | BALLPOINT



EDICIÓN LIMITADA



PRECIO 
\$1,500

EDICIÓN MEISTERSTÜCK

TIPO | ROLLERBALL

PRECIO 
\$700



AARON  JOYEROS

BOLÍGRAFOS



**MONT
BLANC** 



MEISTERSTÜCK

TIPO | BALLPOINT

PRECIO 
\$300

MEISTERSTÜCK

TIPO | RESALTADOR



CAJA

PRECIO 
\$220



AARON  JOYEROS

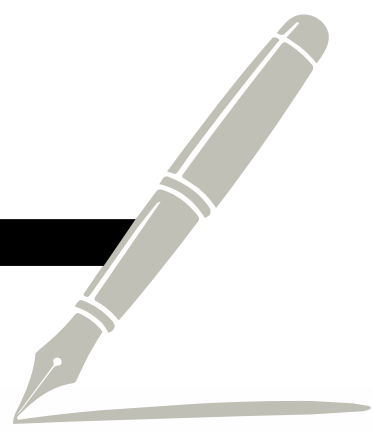

MONT BLANC

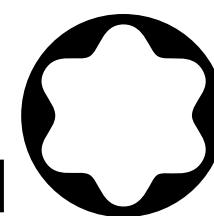

STARWALKER

TIPO | ESTILIGRÁFICA

PRECIO 
\$300



MEISTERSTÜCK

TIPO | BALLPOINT

PRECIO 
\$400



MEISTERSTÜCK

TIPO | BALLPOINT Solitaire Douè

PRECIO 
\$1,400





LE MUST PHANTERE

TIPO | ESTILIGRÁFICA

PRECIO 
\$1,200



DIABOLO



TIPO | BALLPOINT

PRECIO 
\$600



**MONT
BLANC** 

TIPO
Bohème
Rollerball

PRECIO 
\$650



WATERMAN
PARIS

TIPO
EDSON
FUENTE

PRECIO 
\$120



 **PILOT**

TIPO
BLACK
CARBONESQUE
FUENTE

PRECIO 
\$120





AP
AUDEMARS PIGUET
Le maître de l'horlogerie depuis 1875

Fundada en 1875 y reconocida por su independencia, innovación técnica y excelencia artesanal. Ha destacado por el desarrollo de complicaciones de alto nivel y por revolucionar el diseño relojero con piezas icónicas como el Royal Oak. Su enfoque combina tradición, ingeniería avanzada y una estética audaz, representando exclusividad y vanguardia en la alta relojería.

ROYAL OAK

- Oro Rosa
- 44 mm
- Automático

PRECIO
\$40,000

- OBARRIO
- CAJA
- PAPELES



REF. 26401RO.00.A

ROYAL OAK

- Oro Rosa
- 44 mm
- Automático

PRECIO
\$42,000

- OBARRIO
- CAJA
- PAPELES



REF. 26401RO.00.A

ROYAL OAK VOLCANO

- Acero
- 42 mm
- Automático

PRECIO
\$20,000

- OBARRIO



REF. 26170ST. 00.D101CR.01

ROYAL OAK

- Oro / Diamantes
- 29 x 38 mm
- Automático

PRECIO
\$24,000

- OBARRIO



REF. 6005BA

VINTAGE

- Oro Amarillo
- 30.5 mm
- Quartz

PRECIO
\$15,000

- OBARRIO



REF. AP03022201X



Alain Silberstein[®]

Fundada en 1875 y reconocida por su independencia, innovación técnica y excelencia artesanal. Ha destacado por el desarrollo de complicaciones de alto nivel y por revolucionar el diseño relojero con piezas icónicas como el Royal Oak. Su enfoque combina tradición, ingeniería avanzada y una estética audaz, representando exclusividad y vanguardia en la alta relojería.

AARON  JOYEROS

Alain Silberstein®



KRONO BAUHAUS 2

TITANIUM

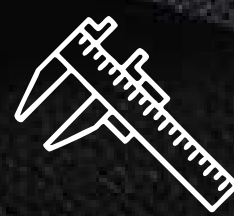

45 mm

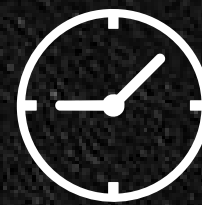

AUTOMÁTICO



CAJA



PAPELES

PRECIO 
\$14,000

REF.



OBARRIO

AARON  JOYEROS
— JOYERIA & RELOJERIA —



**AZIMUT**

Azimuth es una marca de relojería independiente reconocida por sus diseños futuristas, creatividad mecánica y enfoque poco convencional dentro de la alta relojería contemporánea. Sus relojes destacan por complicaciones originales, indicaciones innovadoras del tiempo y una estética audaz inspirada en la ingeniería, la ciencia ficción y el automovilismo, convirtiéndose en piezas exclusivas para coleccionistas que buscan originalidad y carácter.

AARON  JOYEROS

GRAN TURISMO

BLACK PVD



Acero



50 mm



Automático

PRECIO



\$3,000



OBARRIO



AZ.GT.BLKPVD

REF.



BALL

Ball Watch Company es una marca suiza reconocida por su precisión y resistencia, con raíces en la relojería ferroviaria estadounidense. Sus relojes destacan por su durabilidad y el uso de microtubos de gas que garantizan una excelente visibilidad en la oscuridad.

Ball representa fiabilidad, ingeniería y rendimiento dentro de la relojería técnica.

CAPELAND CHRONOGRAPH

 Acero

 43 mm

 Automático

PRECIO 
\$1,500



OBARRIO



CAJA



REF. CM1030D



BAUME & MERCIER
MAISON D'HORLOGERIE GENEVE 1830

Reconocida por su elegancia equilibrada y su enfoque accesible dentro del lujo, Baume & Mercier se posiciona como una distinguida casa suiza de alta relojería. Sus colecciones, como Classima y Clifton, reflejan un estilo clásico con matices contemporáneos, enfocado en la sobriedad y la precisión.

A lo largo de su trayectoria, la marca ha mantenido un firme compromiso con la calidad y el diseño refinado, creando piezas versátiles para el día a día. Baume & Mercier representa armonía, fiabilidad y elegancia atemporal en la relojería suiza.

AARON  JOYEROS



BAUME & MERCIER

MAISON D'HORLOGERIE GENEVE 1830



ÍNDICE

CHRONOGRAPH



ACERO

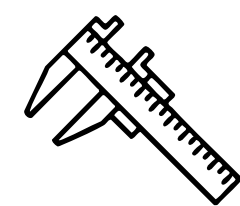

44 mm

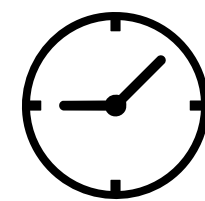

AUTOMÁTICO



OBARRIO

PRECIO



\$2,500

REF.

10066

RIVIERA



-  Acero
-  43 mm
-  Automático

PRECIO 
\$1,800



OBARRIO

REF. 65541

RIVIERA



-  Acero
-  38 mm
-  Quartz

PRECIO 
\$1,500



OBARRIO



CAJA





PAPELES

REF. 26310R.00

RIVIERA



-  Acero
-  43 mm
-  Automático

PRECIO 
\$1,500





OBARRIO

REF. 65541

CLASSIMA



-  Oro
-  24 mm
-  Automático

PRECIO 
\$1,800





OBARRIO

REF. MV045088

RECTANGLE MOTHERS OF PEARLS



-  Acero y Oro
-  22 x 33 mm
-  Quartz

PRECIO 
\$800





OBARRIO

REF. 8600

VINTAGE



-  Acero y Diamantes
-  27 mm
-  Quartz

PRECIO 
\$1,800



OBARRIO

REF. 65347

HAMPTON SPIRIT

"DIAL MADRE PERLA"

-  Acero
-  30 X 31 mm
-  Quartz



PRECIO 
\$1,000

-  CDE
-  CAJA
-  PAPELES



REF. MOA08450

TANK

-  Oro
-  23 x 33 mm
-  Quartz

PRECIO 
\$2,500

-  OBARRIO



REF. 97256

HAMPTON CHRONOGRAPH

-  Acero
-  29 x 44 mm
-  Quartz



PRECIO 
\$1,000

-  OBARRIO



REF. 65341

CATWALK

-  Acero y Diamantes
-  21 mm
-  Automático



PRECIO 
\$650

-  OBARRIO



REF. MV045219

HAMPTON

-  Acero
-  32 mm
-  Automático



PRECIO 
\$950

-  OBARRIO



REF. 65697

CLIFTON GMT

-  Acero
-  43 mm
-  Automático

PRECIO 
\$1,500

-  OBARRIO



REF. MOA10112

HAMPTON
CRONÓGRAFO

-  Acero
-  34 x 29 mm
-  Quartz

PRECIO 
\$700





OBARRIO



REF. 65341

HAMPTON

-  Acero
-  42 x 39 mm
-  Automático

PRECIO 
\$575





OBARRIO



REF. 65402



CLASSIMA
EXECUTIVE

-  Oro
-  38 mm
-  Automático

PRECIO 
\$7,000



OBARRIO



REF. 65627





JB
1735
BLANCPAIN
MANUFACTURE DE HAUTE HORLOGERIE

Blancpain es una de las casas más emblemáticas de la alta relojería, reconocida por su profunda tradición, innovación mecánica y compromiso con la artesanía. Ha destacado por la creación de relojes de gran complejidad y por modelos icónicos como el Fifty Fathoms. Su enfoque une herencia, precisión y elegancia atemporal, representando exclusividad y excelencia relojera.



VILLERET



-  Oro blanco con Diamantes
-  40 mm
-  Automático

REF. 4063-1560-55

PRECIO 
\$12,500



OBARRIO





LEMAN DOUBLE

TIME ZONE



PAPELES



CAJA



OBARRIO

ACERO

REF.

2160-1127-53

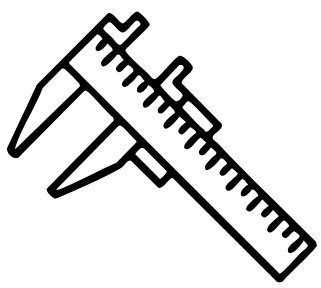

38 mm

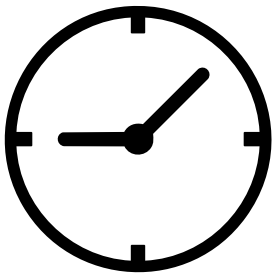



AUTOMÁTICO

PRECIO

\$6,000



GMT
FIFTY FATHOMS

-  Acero
-  40.5 mm
-  Automático

PRECIO 
\$7,500



REF. 2250.1130.71



Bell & Ross

Bell & Ross es una firma reconocida por su diseño inspirado en la aviación y los instrumentos aeronáuticos, combinando funcionalidad, precisión y estética contemporánea. Sus relojes destacan por cajas cuadradas icónicas, legibilidad excepcional y un enfoque técnico que refleja innovación, carácter y espíritu militar moderno.



ÍNDICE

Bell & Ross



Acero



42 mm



Automático

PRECIO 

\$2,400



OBARRIO



REF. BR0392-BL-CE

REF.

AARON  JOYEROS



PREMIUM

Bell & Ross

AVIATION



REF. BR01-92-SHE

-  Acero
-  46 mm
-  Automático

PRECIO 
\$3,300



OBARRIO





BOUCHERON
PARIS

Boucheron es una histórica casa parisina reconocida por su excelencia en alta joyería y su enfoque artístico en la relojería. Sus creaciones combinan diseño innovador, elegancia y un fuerte carácter estético.

Boucheron representa creatividad, sofisticación y savoir-faire dentro del universo del lujo.

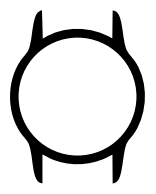
REFLET DIAMANTE



ACERO

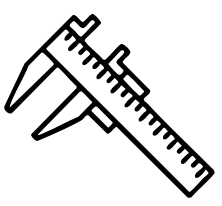

18 X 29 mm

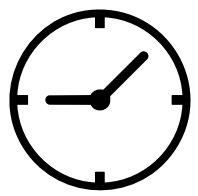

QUARTZ

PRECIO 
\$1,200

REF.

20 30 53



OBARRIO



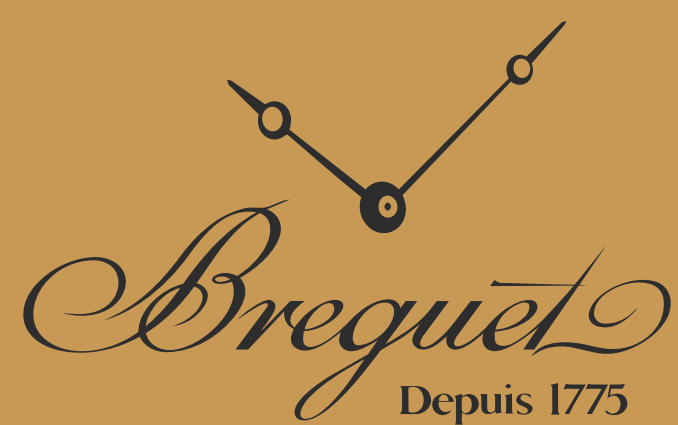

Breguet es una de las casas más influyentes en la historia de la relojería, reconocida por su innovación, elegancia y legado técnico. Sus creaciones se distinguen por detalles clásicos como las agujas Breguet y esferas guilloché, reflejando un estilo refinado y atemporal.

Breguet representa tradición, sofisticación y una profunda contribución al desarrollo de la alta relojería.

AERONAVALE

 Oro Rosa / Cuero

 39 mm

 Automático

PRECIO 
\$18,600



OBARRIO



REF. 3800





BREITLING
1884

Reconocida casa suiza de alta relojería, destacada por su precisión, innovación y fuerte vínculo con la aviación. Ha sobresalido por el desarrollo de cronógrafos profesionales y modelos icónicos como el Navitimer. Su enfoque combina rendimiento, funcionalidad y diseño robusto, representando espíritu técnico y excelencia en relojería deportiva.

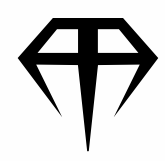

ÍNDICE



BREITLING
1884

NAVITIMER B03

CHRONOGRAPH RATTRAPANTE 45

ACERO

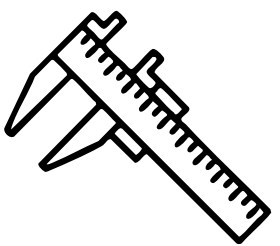

45 mm

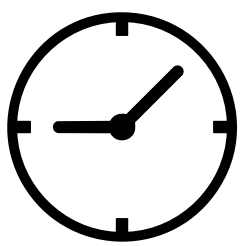

AUTOMÁTICO

PRECIO 
\$7,800



OBARRIO



CAJA



PAPELES

REF.

AB03102A1F1A1

AARON  JOYEROS

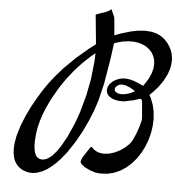

BREITLING
1884



ÍNDICE



OBARRIO

NAVITIMER CHRONOGRAPH

ACERO

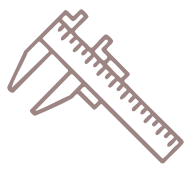

45 mm



AUTOMÁTICO

PRECIO 
\$7,000



CAJA



PAPELES

REF. AB031021/Q615



REF.

B
BREITLING
1884



CHRONOMAT 44

RAVEN

-  Acero
-  44 mm
-  Automático



CDE

PRECIO 
\$4,800

REF. MB011C2

AVENGER
SEAWOLF

- Acero
- 45 mm
- Automático

PRECIO 
\$2,600



OBARRIO



REF. A17330

STARLINER

"Dial Azul Madre Perla"

- Acero
- 30 mm
- Quartz

PRECIO 
\$2,800



OBARRIO



REF. A71340

NAVITIMER

- Acero
- 38 mm
- Automático

PRECIO 
\$3,200



CDE



REF. A17325211C1P3

AVENGER

- Acero
- 44 mm
- Automático

PRECIO 
\$3,500



OBARRIO



REF. A32320

SUPER AVENGER

- Acero
- 45 mm
- Automático

PRECIO 
\$3,500



OBARRIO



REF. A73321

SUPER OCEAN

- Acero
- 44 mm
- Automático

PRECIO 
\$4,000



CDE



REF. A13341

CHRONOMAT
EVOLUTION

- Acero y Oro
- 44 mm
- Automático

PRECIO 
\$6,800



OBARRIO



REF. CB0110

COCKPIT B50
NIGHT MISSION

- Titanio
- 46 mm
- Automático

PRECIO 
\$4,800



OBARRIO



REF. VB501022.BD41.155S.V20DSA.2

ENDURANCE
PRO

- Carbono
- 44 mm
- Quartz

PRECIO 
\$2,600



OBARRIO



CAJA



PAPELES



REF. X82310A51B1S1

COCKPIT
B50

"Nuevo a Estrenar"

- Titanio
- 45 mm
- Automático

PRECIO 
\$4,800



OBARRIO



CAJA



PAPELES



REF. VB5010

CHRONO COCKPIT

- Acero y Oro
- 39 mm
- Automático

PRECIO 
\$3,000



OBARRIO



REF. B13358

EXOSPACE

- Titanio
- 46 mm
- Automático

PRECIO 
\$4,500



OBARRIO



REF. VB5510

SUPER OCEAN
AEROMARIN

- Acero
- 42 mm
- Automático

PRECIO 
\$3,600

-  OBARRIO
-  CAJA
-  PAPELES



REF. A17367

CHRONOMAT

- Acero
- 47 mm
- Automático

PRECIO 
\$4,200

-  OBARRIO



REF. AB0412

AVENGER

- Titanium
- 44 mm
- Automático

PRECIO 
\$3,000

-  OBARRIO



REF. E13360

SUPER AVENGER

- Acero
- 48 mm
- Automático

PRECIO 
\$3,800

-  OBARRIO



REF. A13370

COLT GMT

- Acero
- 40.5 mm
- Automático

PRECIO 
\$2,200

-  OBARRIO



REF. A3235011

GALACTIC 36
SLEEK

- Acero
- 36 mm
- Automático



PRECIO 
\$2,300

-  CDE



REF. W74330

BENTLEY WRISTWATCH
CHRONOGRAPH

-  Titanio
-  49 mm
-  Automático

PRECIO 
\$6,000



OBARRIO



REF. E273622/BC63

COLT CHRONOGRAPH

-  Acero
-  41 mm
-  Quartz

PRECIO 
\$2,000



OBARRIO



REF. A73380



LADY J

-  Acero / Oro
-  31 mm
-  Quartz

PRECIO 
\$2,500





OBARRIO



REF. D52065



AEROSPACE

-  Oro
-  40 mm
-  Quartz

PRECIO 
\$7,000



OBARRIO



REF. K65062



BVLGARI

Bvlgari destaca en la alta relojería por su enfoque creativo y su capacidad de reinterpretar el diseño clásico con una estética contemporánea. Reconocida por piezas emblemáticas como el Octo, ha logrado unir ingeniería suiza con una fuerte identidad italiana. Sus creaciones reflejan innovación, carácter arquitectónico y una visión moderna del lujo relojero.

BVLGARI



REF. DGP40C6GLDGMT

DIAGONO

-  Oro Rosa
-  40 mm
-  Automático





OBARRIO

PRECIO 
\$14,500

GMT

AARON  JOYEROS

DIAGONO

-  Acero
-  42 mm
-  Automático

PRECIO 
\$7,000





OBARRIO



REF. 42 SC CH

DIAGONO GMT

-  Acero
-  42 mm
-  Automático

PRECIO 
\$4,500





OBARRIO



REF. DP42SGMT

DANIEL ROTH

-  Acero
-  47 mm
-  Automático

PRECIO 
\$7,000





OBARRIO



REF. BRE 56S CHS

OCTO FINISSIMO

-  Acero
-  40 mm
-  Automático

PRECIO 
\$12,500



OBARRIO



CAJA



PAPELES



REF. BG040C

MOP LADY

"MADRE PERLA"

-  Acero/Oro Rosa
-  37 mm
-  Automático

PRECIO 
\$7,000



OBARRIO





PAPELES



REF. BBL P37 SG

OCTO FINISSIMO

-  Oro Rosa
-  40 mm
-  Automático

PRECIO 
\$32,600





OBARRIO



REF. 104190

SOTIRIO

-  Oro Rosa
-  42 mm
-  Automático

PRECIO 
\$13,500



OBARRIO



REF. 101705

B.ZERO1

-  Acero
-  35 mm
-  Quartz

PRECIO 
\$1,800





OBARRIO



REF. BZ35BHDSGL/2

DANIEL ROTH

-  Acero
-  28.6 mm
-  Automático

PRECIO 
\$900





OBARRIO



REF. BRE 56S CHS

RETTANGOLO

-  Acero
-  38.4 mm
-  Quartz

PRECIO 
\$1,800





OBARRIO



REF. RT39S

PURPLE DIAMOND

-  Acero
-  33 mm
-  Automático

PRECIO 
\$3,000



OBARRIO





PAPELES



REF. BBL33S

DIAGONO

-  Acero
-  38 mm
-  Automático

PRECIO 
\$3,500





OBARRIO



REF. BB 38 SS CH

DIAGONO GMT

-  Oro Rosa
-  40 mm
-  Automático

PRECIO 
\$14,500





OBARRIO



REF. DGP40C6GLDGMT

ASSIOMA

-  Acero
-  48 mm
-  Automático

PRECIO 
\$4,000



OBARRIO



REF. AA 48 S CH

BVLGARI LADY

-  Acero/Diamante
-  33 mm
-  Automático

PRECIO 
\$3,500



OBARRIO



CAJA



REF. BBL 33WSLC4

BVLGARI

-  Acero
-  23 mm
-  Quartz

PRECIO 
\$1,000



OBARRIO



CAJA



PAPELES



REF. BB23SS

RETTANGOLO

-  Oro Amarillo
-  25 X 45 mm
-  Automático

PRECIO 
\$7,850





OBARRIO



REF. RT 45 G

DIAGONO

-  Titanio
-  38 mm
-  Automático

PRECIO 
\$2,500





OBARRIO



REF. TI 38 R

DIAGONO

-  Acero
-  40 mm
-  Automático

PRECIO 
\$2,500



REF. DG 40 SV





Cartier

Prestigiosa maison de lujo reconocida por su herencia histórica, excelencia artesanal y enfoque artístico en la alta relojería.

A lo largo de su trayectoria, Cartier ha sabido fusionar innovación técnica con una profunda sensibilidad estética, dando vida a piezas que trascienden el tiempo. Hoy, la marca representa elegancia, sofisticación y un legado de creatividad que continúa influyendo en la relojería contemporánea.

Cartier

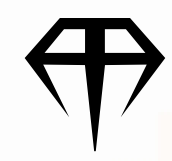

ÍNDICE

PANTHERE VENDOME

"18K"

 Oro Amarillo

 22 mm

 Quartz

PRECIO 
\$9,650



AARON  JOYEROS

Cartier



 Oro

 39.8 mm

 Automático

PRECIO 
\$35,000



OBARRIO

CAJA

AARON  JOYEROS

PANTHERE	SANTOS	TANK	ROADSTER	BALLON BLEU	PASHA
RONDE	MUST	CLÉ	CALIBRE		

SANTOS GALBBÉ

-  Acero
-  29 mm
-  Quartz



PRECIO 
\$5,500

-  OBARRIO
-  CAJA
-  PAPELES



REF. 1564

SANTOS 100 XL

-  Acero
-  39.8 mm
-  Automático



PRECIO 
\$7,500

-  OBARRIO
-  CAJA



REF. 4072

SANTOS GALBBÉ

-  Acero / Oro Ama.
-  29 mm
-  Automático

PRECIO 
\$6,000

-  OBARRIO
-  CAJA



REF. W20041C4

SANTOS GALBBÉ

-  Acero
-  29 mm
-  Quartz



PRECIO 
\$5,200

-  OBARRIO



REF. 1564

SANTOS RONDÉ

-  Acero / Oro
-  33 mm
-  Automático



PRECIO 
\$5,000

-  OBARRIO



REF. 1910

SANTOS XL

-  Acero
-  39.8 mm
-  Automático

PRECIO 
\$6,500

-  OBARRIO



REF. 4072

PANTHERE	SANTOS	TANK	ROADSTER	BALLON BLEU	PASHA
RONDE	MUST	CLÉ	CALIBRE		

TANK

-  Acero
-  28 mm
-  Quartz



PRECIO 
\$4,000



REF. 2302



TANK ANGLAISE

-  Oro Rosa
-  47 X 35.2 mm
-  Automático



PRECIO 
\$35,520



REF. W531002



TANK AMERICANO

-  Oro Blanco
-  41 mm
-  Automático



PRECIO 
\$15,000



REF. 1726



TANK

-  Oro Amarillo
-  28 X 36 mm
-  Automático



PRECIO 
\$6,650



REF. 1830



TANK MUST

-  Acero
-  29.5 mm
-  Automático

PRECIO 
\$4,500



REF. W5200028



PANTHERE	SANTOS	TANK	ROADSTER	BALLON BLEU	PASHA
RONDE	MUST	CLÉ	CALIBRE		

ROADSTER

-  Oro 18 K
-  38 x 43 mm
-  Automático

PRECIO 
\$20,650





OBARRIO



REF. 2619

ROADSTER

"18 QUILATES"

-  Oro Amarillo
-  47.6 x 42.8 mm
-  Automático

PRECIO 
\$20,850





OBARRIO



REF. 2619

ROADSTER

"18 QUILATES"

-  Oro Amarillo
-  44 x 37 mm
-  Automático

PRECIO 
\$14,500





OBARRIO



REF. 2524

ROADSTER TORTUE PERPETUAL

-  Oro Rosa
-  42.5 34 mm
-  Automático

PRECIO 
\$30,000



OBARRIO



REF. 2666

Cartier



Acero



44 mm



Automático

PRECIO



\$6,500



OBARRIO



REF.

3109

BALFOUR

PANTHERE	SANTOS	TANK	ROADSTER	BALLON BLEU	PASHA
RONDE	MUST	CLÉ	CALIBRE		

BALLON BLEU



-  Oro Blanco
-  36 mm
-  Automático

PRECIO 
\$9,000



REF. 3004

BALLON BLEU



-  Acero
-  42 mm
-  Automático

PRECIO 
\$5,000



REF. 3765

BALLON BLEU



-  Oro Rosa
-  42 mm
-  Automático

PRECIO 
\$13,800



REF. 2999

BALLON BLEU

-  Oro Rosa
-  44 mm
-  Automático



PRECIO 
\$14,500



REF. 3107

BALLON BLEU

"BISEL AFTERMARKET"

-  Acero
-  40 mm
-  Automático

PRECIO 
\$6,800



REF. 3001

BALLON BLEU

-  Acero / Oro Ros
-  42 mm
-  Automático

PRECIO 
\$9,000



REF. 3765

Cartier

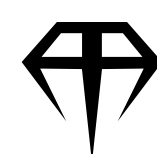

ÍNDICE

PANTHERE	SANTOS	TANK	ROADSTER	BALLON BLEU	PASHA
RONDE	MUST	CLÉ	CALIBRE		



PASHA

- Acero
- 38 mm
- Automático

PRECIO
\$4,500

OBARRIO



AARON JOYEROS

PANTHERE	SANTOS	TANK	ROADSTER	BALLON BLEU	PASHA
RONDE	MUST	CLÉ	CALIBRE		

PASHA



- Oro Blanco
- 32 mm
- Automático

PRECIO
\$8,500



OBARRIO

REF. 2528



PASHA



- Oro
- 38 mm
- Quartz

PRECIO
\$10,500



CDE

REF. 1987



PASHA



- Acero
- 33 mm
- Quartz

PRECIO
\$3,200



OBARRIO

REF. W3140001





PANTHERE	SANTOS	TANK	ROADSTER	BALLON BLEU	PASHA
RONDE	MUST	CLÉ	CALIBRE		

RONDE



REF. 3517

-  Acero
-  42 mm
-  Automático

PRECIO 
\$4,000





OBARRIO



RONDE SOLO XL



REF. 3802

-  Acero
-  42 mm
-  Automático

PRECIO 
\$3,500



CDE



PANTHERE	SANTOS	TANK	ROADSTER	BALLON BLEU	PASHA
RONDE	MUST	CLÉ	CALIBRE		

MUST

21

 Acero / Oro

 28 mm

 Quartz

PRECIO 

\$1,800



OBARRIO



REF.

1340



PANTHERE	SANTOS	TANK	ROADSTER	BALLON BLEU	PASHA
RONDE	MUST	CLÉ	CALIBRE		

CLÉ



REF. 3850

- Acero
- 40 mm
- Automático

PRECIO \$4,200



OBARRIO

CLÉ



REF. 3847

- Oro Rosa
- 40 mm
- Automático

PRECIO \$25,000



OBARRIO



PANTHERE	SANTOS	TANK	ROADSTER	BALLON BLEU	PASHA
RONDE	MUST	CLÉ	CALIBRE		

CALIBRE

 Acero / Oro Rosa

 42 mm

 Automático

PRECIO 
\$6,200



OBARRIO



REF. 3389

CALIBRE

 Acero / Oro Rosa

 42 mm

 Automático

PRECIO 
\$7,000



OBARRIO



REF. 3389

CALIBRE

 Oro Rosa

 42 mm

 Automático

PRECIO 
\$37,000



OBARRIO



REF. 3300

CALIBRE

 Acero / Oro Rosa

 42 mm

 Automático

PRECIO 
\$9,800



OBARRIO



REF. W7100042

CALIBRE

 Acero / Oro

 42 mm

 Automático

PRECIO 
\$6,000



OBARRIO



CAJA



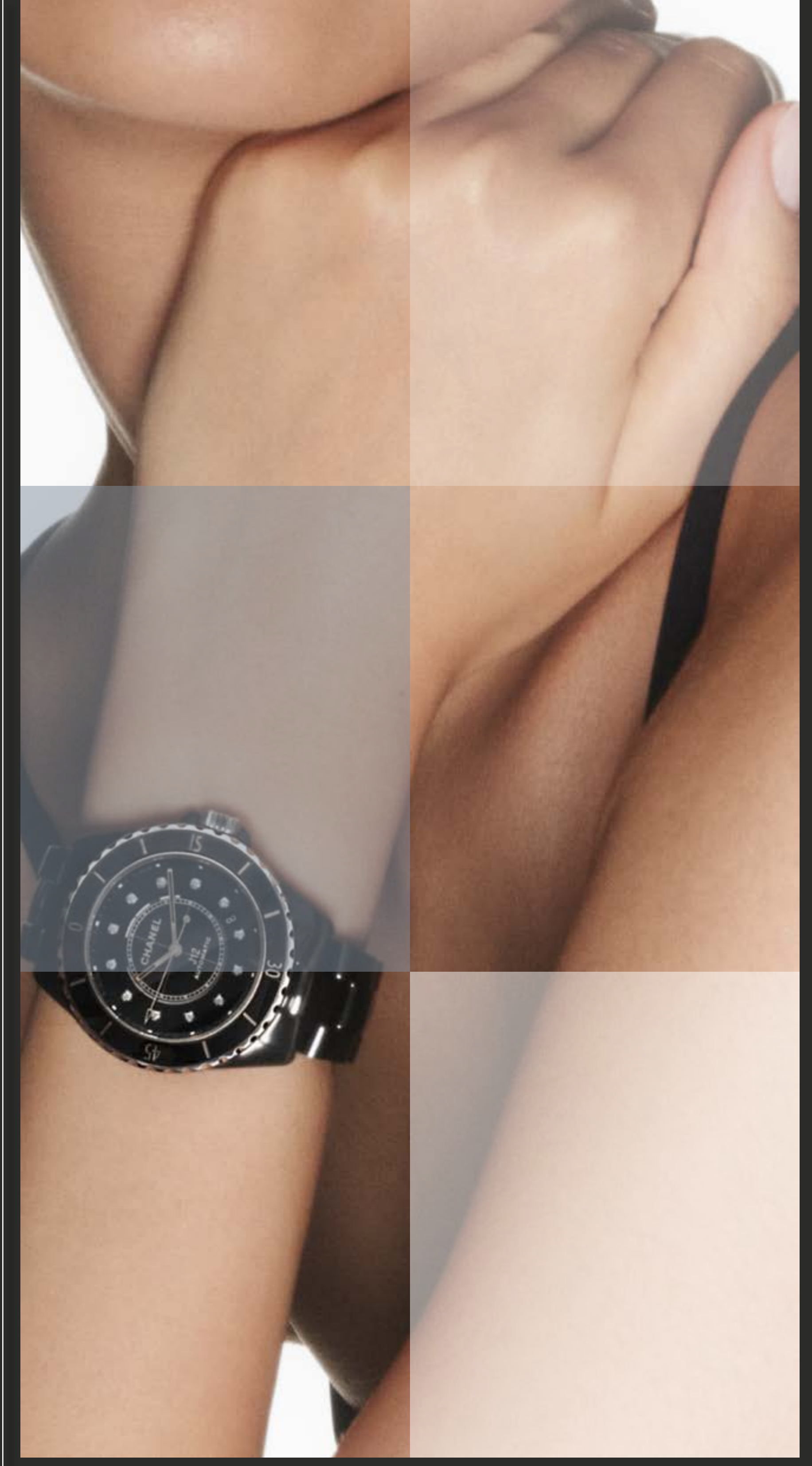

REF. W2CA0004



CHANEL

Chanel ha consolidado su presencia en la alta relojería mediante una propuesta que combina diseño vanguardista y precisión suiza. Sus colecciones, como J12 y Première, reflejan una estética distintiva que une elegancia contemporánea y carácter innovado. A lo largo de su evolución, la marca ha redefinido los códigos del reloj femenino y unisex, integrando materiales y formas poco convencionales. Chanel representa estilo, modernidad y una visión creativa única dentro del universo relojero.

J1

-  Cerámica
-  41 mm
-  Automático

PRECIO 
\$2,750



OBARRIO





PAPELES



REF. H2934

J12

-  Cerámica
-  39 mm
-  Automático

PRECIO 
\$2,750





OBARRIO



REF. H2934

J12 NOIRE

-  Cerámica
-  38 mm
-  Automático

PRECIO 
\$2,600



OBARRIO



REF. H5702





CHAUMET

PARIS

Chaumet ha desarrollado una propuesta relojera que combina elegancia, refinamiento y savoir-faire parisino. Sus creaciones destacan por su diseño delicado y su atención al detalle, integrando la relojería con el arte joyero. A lo largo de su trayectoria, la marca ha sabido expresar sofisticación a través de piezas que priorizan la estética sin perder precisión. Chaumet representa distinción, feminidad y tradición dentro del universo de la alta relojería.

KHESIS

 Acero/Nácar/Diamantes

 21 mm

 Quartz

PRECIO 
\$2,000





OBARRIO



REF. 40 38 44

KHESIS

 Acero/Diamantes

 17.5 x 28 mm

 Quartz

PRECIO 
\$1,800





OBARRIO



REF. 1.2330_PK

CLASS ONE CHRONO

 Acero

 40 mm

 Quartz

PRECIO 
\$1,800





OBARRIO



REF. 625B

STYLE

 Acero/Diamantes

 19 x 23 mm

 Quartz

PRECIO 
\$500



OBARRIO



REF. 35 34 13

MONTRE CHAUMET CHRONOGRAPHE

 Acero

 40 mm

 Automático

PRECIO 
\$3,600



OBARRIO



REF. 0000



Chopard

GENÈVE

Chopard es una reconocida casa suiza que combina alta relojería y joyería con un enfoque en la elegancia, la innovación y la artesanía. Sus creaciones destacan por la atención al detalle y el uso de materiales de alta calidad.

A lo largo de su trayectoria, la marca ha desarrollado colecciones icónicas que equilibran técnica y estética, consolidando su presencia en el mundo del lujo. Chopard representa refinamiento, creatividad y excelencia dentro del universo relojero.

Chopard

GENÈVE



Oro



44 mm



Automático

PRECIO



\$19,000

REF.

161276-5001



OBARRIO

MILLE MIGLIA



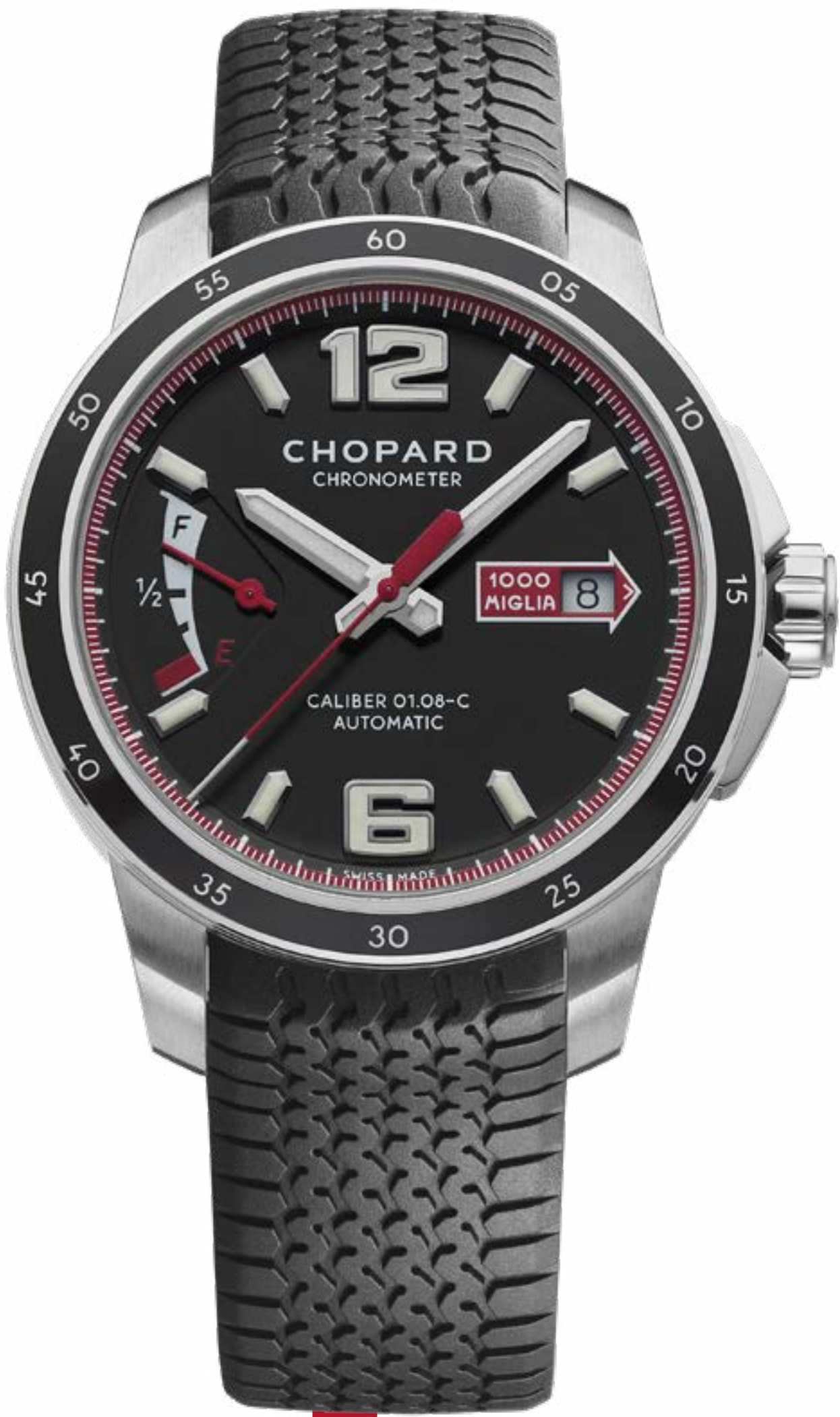

Chopard
GENÈVE

MILLE MIGLIA GTS



OBARRIO



CAJA



PAPELES



POWER CONTROL
ACERO

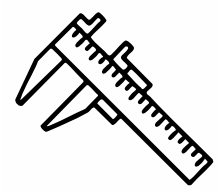

43 mm

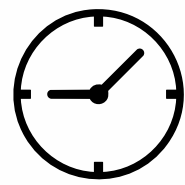

AUTOMÁTICO

PRECIO 
\$4,800

REF. 168566-3001



Chopard
GENÈVE

HAPPY DIAMOND

ORO/DIAMANTES

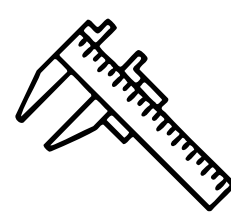

25 mm

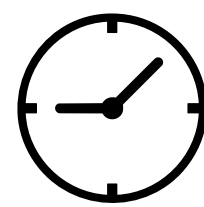

QUARTZ

PRECIO 
\$4,800

REF.

20/5605

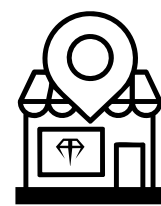

OBARRIO

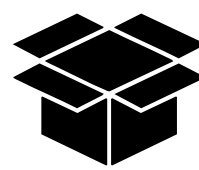

CAJA

GRAN TURISMO

XL

- Acero
- 44 Mm
- Automático

PRECIO 
\$4,500



CDE



REF. 8997

SUPERFAST

- Acero
- 44 mm
- Automático

PRECIO 
\$5,500



OBARRIO



REF. 8542

GRAN TURISMO

XL

- Acero
- 44 mm
- Automático

PRECIO 
\$3,500



OBARRIO



REF. 8997

GRAND PRIX DE MÓNACO

- Acero
- 42.5 mm
- Automático

PRECIO 
\$3,800



CDE



REF. 168992-3031

MIGLIA CHRONOGRAPH

- Oro
- 39 mm
- Automático

PRECIO 
\$16,100



OBARRIO



CAJA



PAPELES



REF. 1274

HAPPY BEACH

- Oro Rosa
- 42 mm
- Quartz

PRECIO 
16,000



OBARRIO



REF. 283581-5011

IMPERIALE
CHRONO

- Acero
- 38 mm
- Automático

PRECIO 
\$2,500



REF. 8219

MILLE
MIGLIA

- Acero
- 38 mm
- Automático

PRECIO 
\$5,000



REF. 8588

IMPERIALE
CHRONO

- Acero
- 37 mm
- Automático

PRECIO 
\$3,000



REF. 8219

IMPERIALE
CHRONO

- Acero
- 40 mm
- Automático

PRECIO 
\$5,500



REF. 8549

HAPPY SPORT

- Acero
- 38 mm
- Quartz

PRECIO 
\$4,800



REF. 8347

CHOPARD
CHOPARD LUNA D'ORO

- Oro Amarillo
- 34 mm
- Quartz

PRECIO 
\$3,875



REF. 1086

HAPPY SPORT

Acero / Oro Rosa

36 mm

Quartz

PRECIO \$7,000



OBARRIO



REF. 8475

HAPPY SPORT

Acero

36 mm

Quartz

PRECIO \$4,500



OBARRIO



CAJA



PAPELES



REF. 8475

HAPPY SPORT

Acero

42 mm

Quartz

PRECIO \$4,000



OBARRIO



REF. 288525-3002

HAPPY BEACH DIAMOND BLUE

Acero

38 mm

Quartz

PRECIO \$3,200



OBARRIO



REF. 8542

HAPPY SPORT

Acero

38 mm

Quartz

PRECIO \$2,000



OBARRIO



REF. 8347

HAPPY SPORT

Acero

42 mm

Quartz

PRECIO \$4,500



OBARRIO



REF. 288499-3008

GRAN TURISMO
XL

- Acero
- 44 mm
- Automático

PRECIO 
\$3,500

-  OBARRIO
-  CAJA
-  PAPELES



REF. 8997

MILLE MIGLIA
ALFA ROMEO

"EDICIÓN LIMITDA"

- Acero
- 42 mm
- Automático

PRECIO 
\$2,400

-  OBARRIO



REF. 8954



MILLE MIGLIA
GRAN TURISMO

- Acero
- 44 mm
- Automático

PRECIO 
\$3,800

-  OBARRIO



REF. 168997



MIGLIA

- Acero
- 40 mm
- Automático

PRECIO 
\$2,600

-  OBARRIO



REF. 8955



CONCORD

Concord es una casa relojera suiza reconocida por su enfoque en la innovación y el diseño contemporáneo dentro del segmento de lujo. Sus creaciones se distinguen por líneas modernas y una marcada identidad estética.

A lo largo de su historia, la marca ha explorado conceptos audaces que rompen con lo tradicional. Concord representa modernidad y evolución en el diseño relojero.



CONCORD

CONCORD MARINER

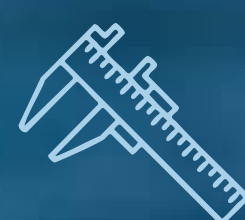

38 mm



AUTOMÁTICO

ACERO
PRECIO:

PRECIO 
\$950



OBARRIO

REF.

14H71891



CORUM



Concord es una casa relojera suiza reconocida por su enfoque en la innovación y el diseño contemporáneo dentro del segmento de lujo. Sus creaciones se distinguen por líneas modernas y una marcada identidad estética.

A lo largo de su historia, la marca ha explorado conceptos audaces que rompen con lo tradicional. Concord representa modernidad y evolución en el diseño relojero.

AARON  JOYEROS

ADMIRAL'S CUP



-  Oro Rosa
-  44 mm
-  Automático

PRECIO 
\$12,000



REF. 753 812

VINTAGE



-  Oro / Cuero
-  24 mm
-  Quartz

PRECIO 
\$4,000





REF. 0000

ADMIRAL'S CUP

"BISEL/CORONA ORO ROSA"



-  Acero / Oro
-  48 mm
-  Automático



PRECIO 
\$5,500



REF. A690/04312

ADMIRAL'S CUP



-  Acero
-  41 mm
-  Automático

PRECIO 
\$2,500



REF. 82.833.20



DEVON

Devon ha fusionado ingeniería de alto nivel con una estética disruptiva. Devon representa vanguardia, innovación y una visión tecnológica del tiempo. Es una innovadora firma estadounidense que ha redefinido la relojería mediante el uso de tecnología avanzada y diseño futurista. Sus relojes destacan por sistemas de correas motorizadas y mecanismos electrónicos únicos, alejándose de la relojería tradicional.

AARON  JOYEROS

TREAD 2 REDRUM



Acero



44.2 x 41.7 mm

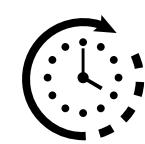

Quartz

PRECIO 

\$6,000



OBARRIO



CAJA

REF.

M0064

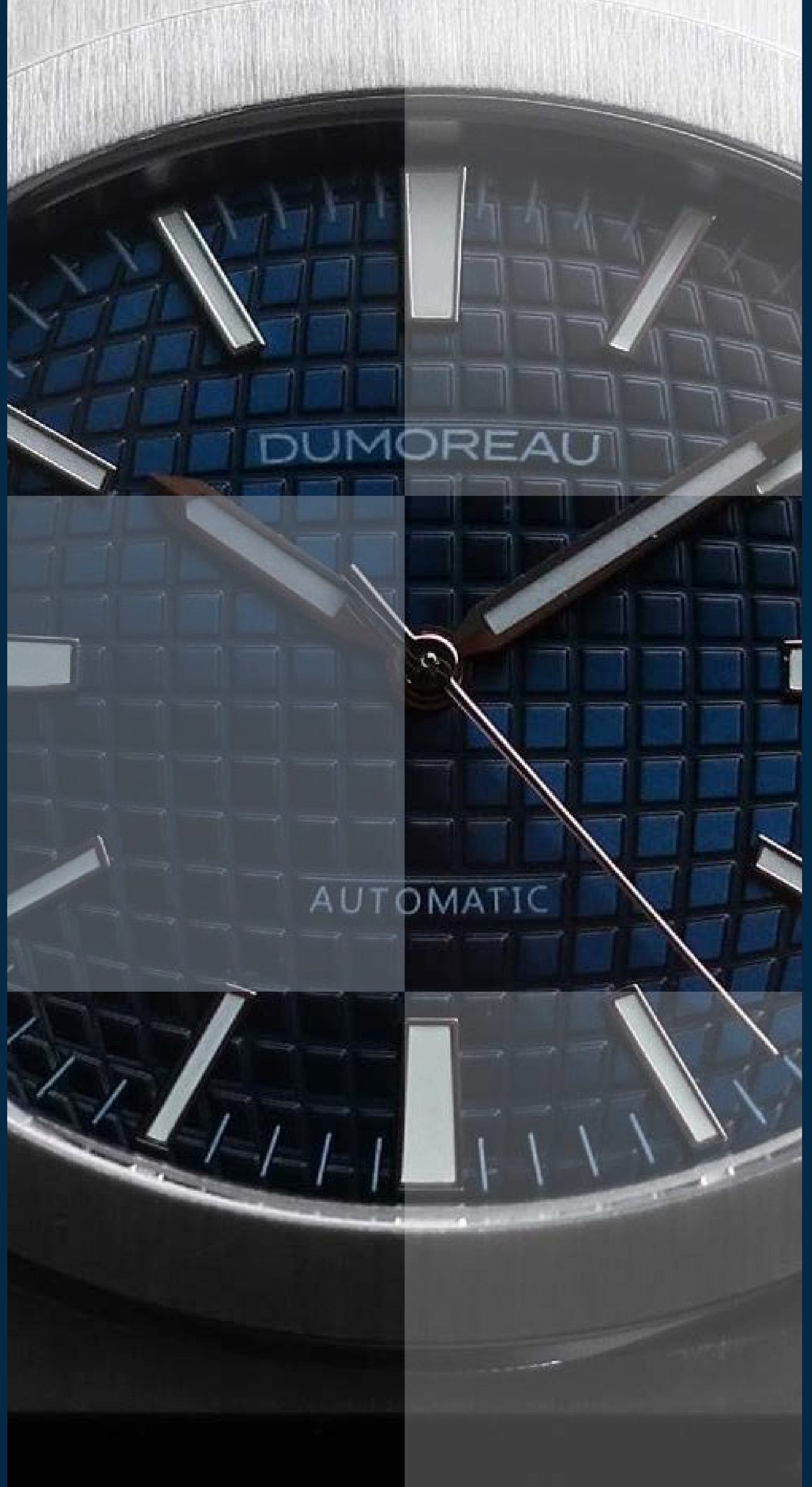

DUMOREAU

Devon ha fusionado ingeniería de alto nivel con una estética disruptiva. Devon representa vanguardia, innovación y una visión tecnológica del tiempo. Es una innovadora firma estadounidense que ha redefinido la relojería mediante el uso de tecnología avanzada y diseño futurista. Sus relojes destacan por sistemas de correas motorizadas y mecanismos electrónicos únicos, alejándose de la relojería tradicional.

DUMOREAU



 Acero

 38.6 mm

 Automático

PRECIO 
\$700

OBARRIO

REF. DM-01



⌘
EBEL

La casa Ebel se ha caracterizado por crear piezas que priorizan el detalle y la comodidad en la muñeca. Ebel representa sofisticación discreta y tradición dentro de la relojería suiza. Conocida por su estilo elegante y equilibrado, donde el diseño y la precisión se combinan de forma armoniosa. Sus relojes destacan por líneas refinadas y una estética atemporal que ha definido su identidad a lo largo de los años.

AARON ⌘ JOYEROS

SPORT WAVE



ACERO

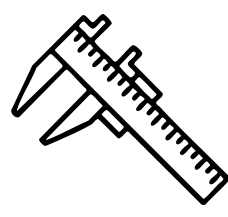

28 mm

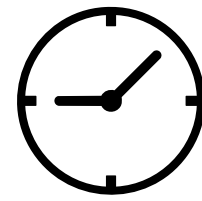

QUARTZ

PRECIO 
\$750

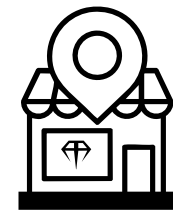

OBARRIO



CAJA

REF. E9955K41

SPORT WAVE



REF. E9087622

- Acero
- 36 mm
- Quartz

PRECIO \$900



OBARRIO

CLASSIC WAVE



REF. 888901

- Oro Amarillo
- 23 mm
- Quartz

PRECIO \$13,300



CDE

DRESSWAVE



REF. E6157912

- Acero y Oro
- 24 mm
- Quartz

PRECIO \$700



OBARRIO

SPORT WAVE



REF. 12607794

- Acero
- 26 mm
- Quartz

PRECIO \$1,200



OBARRIO

DRESS WAVE



REF. 98501259

- Acero
- 35 mm
- Quartz

PRECIO \$750



OBARRIO



PAPELES

SPORT WAVE CLASSIC



REF. E 6187631

- Acero / Oro Ama
- 27 mm
- Quartz

PRECIO \$800



OBARRIO

SPORT WAVE

- Acero
- 36 mm
- Quartz

PRECIO 
\$900



OBARRIO



REF. E6187631

EBEL

- Acero / Oro
- 34 mm
- Automático

PRECIO 
\$1,500



OBARRIO



REF. W522084

LADY SPORT

- Acero / Oro
- 27 mm
- Quartz

PRECIO 
\$900



OBARRIO



CAJA



REF. EBL-010

LADY

- Acero / Oro
- 23 mm
- Automático

PRECIO 
\$1,300



OBARRIO



REF. 1057902

SPORTWAVE

- Acero
- 36 mm
- Automático

PRECIO 
\$400



OBARRIO



REF. E6120531

E-TYPE

- Acero
- 36 mm
- Quartz

PRECIO 
\$1,000



OBARRIO



REF. E9187C41



EBERHARD & Co.

Eberhard & Co. es una prestigiosa casa relojera suiza fundada en 1887, reconocida por su tradición en relojes deportivos y cronógrafos de alta precisión.

La marca se ha distinguido por combinar elegancia clásica, innovación mecánica y una fuerte identidad técnica. Sus colecciones destacan por diseños refinados, movimientos de calidad y una atención minuciosa a los detalles.

AARON  JOYEROS

8 DÍAS



REF. 20017

-  Oro
-  39 mm
-  Cuerda Manual

PRECIO 
\$7,000



OBARRIO



CAJA







EDOX

Reconocida por su enfoque en la precisión y la resistencia, especialmente en relojes deportivos y de buceo. Sus creaciones combinan ingeniería robusta con un diseño funcional, orientado al rendimiento en condiciones exigentes.

A lo largo de su trayectoria, la marca ha desarrollado modelos fiables y técnicos, consolidando su reputación en la relojería deportiva. Edox representa durabilidad, exactitud y espíritu aventurero.

AARON  **JOYEROS**

EDOX

-  Acero
-  46 mm
-  Quartz

PRECIO 
\$900



REF. 10021 3 NIN



F
FENDI

Fendi combina la elegancia italiana con la precisión suiza, creando relojes que destacan por su diseño sofisticado y moderno. Sus piezas priorizan la estética, los detalles de moda y materiales de alta calidad, posicionándose como accesorios de lujo más que relojes técnicos.

AARON  JOYEROS

RUN AWAY

- Acero
- 36 mm
- Quartz

PRECIO \$500



OBARRIO



REF. FOW807A5UGF0QA1

RUN AWAY

- Acero
- 36 mm
- Quartz

PRECIO \$340



OBARRIO



REF. F136031573T01





FREDERIQUE CONSTANT GENEVE

Frederique Constant es una reconocida casa suiza que se distingue por ofrecer alta relojería accesible, combinando tradición, elegancia y manufactura propia. Sus diseños reflejan un estilo clásico y refinado, con un fuerte enfoque en la precisión y la calidad.

A lo largo de su trayectoria, la marca ha impulsado la innovación con calibres propios y complicaciones bien ejecutadas. Frederique Constant representa equilibrio, accesibilidad y excelencia dentro de la relojería suiza contemporánea.



FREDERIQUE CONSTANT
GENEVE



CLASSICS



 Acero

 42 mm

 Automático

PRECIO 
\$850





OBARRIO



FREDERIQUE CONSTANT



-  Acero
-  31 mm
-  Quartz

PRECIO 
\$800



REF. FC-220X2ER22



GP GIRARD-PERREGAUX

Girard-Perregaux es una manufactura suiza fundada en 1791, reconocida por su tradición, innovación y excelencia en la alta relojería. Destaca por sus movimientos propios y por el icónico Tourbillon de Tres Puentes de Oro, símbolo de su fusión entre ingeniería y elegancia atemporal.

GYROMATIC

-  Oro
-  34 mm
-  Automático

PRECIO 
\$3,500



REF. 352



GRAHAM

//// //// //// LONDON

Distintiva firma relojera suiza conocida por su fuerte carácter técnico y diseño audaz. Sus relojes destacan por elementos únicos como el gatillo lateral del cronógrafo, inspirado en la instrumentación aeronáutica y militar.

A lo largo de su evolución, la marca ha mantenido un enfoque en la innovación y la funcionalidad, creando piezas con gran presencia y personalidad. Graham representa ingeniería, originalidad y espíritu deportivo en la relojería contemporánea.

CHRONOFIGHTER
OVERSIZE SAHARA

- Acero
- 46 mm
- Automático

PRECIO 
\$3,000

-  OBARRIO
-  CAJA

REF. 2CCAU.B02A.T13N



CHRONOFIGHTER
OVERSIZE

- Acero
- 47 mm
- Automático

PRECIO 
\$3,000

-  OBARRIO
-  CAJA
-  PAPELES

REF. 20VDIVAZ.B02A.K10B



CHRONOFIGHTER
OVERSIZE

- Acero
- 47 mm
- Automático

PRECIO 
\$3,800

-  OBARRIO

REF. OR-20VBV-1





GUCCI



Gucci es una influyente casa de lujo que ha extendido su creatividad al mundo de la relojería, destacándose por su enfoque en el diseño y la expresión estética. Sus relojes reflejan una identidad audaz y contemporánea, combinando moda, innovación y detalles distintivos.

A lo largo del tiempo, la marca ha desarrollado piezas que priorizan el estilo sin dejar de lado la calidad y la precisión. Gucci representa modernidad, tendencia y una visión creativa dentro del universo relojero.

AARON  JOYEROS

GUCCI



-  Acero
-  38 mm
-  Automático

PRECIO 
\$1,000

MARKETS



REF

136.2



OBARRIO

AARON  JOYEROS



★
HAMILTON

Hamilton es una marca histórica de la relojería reconocida por combinar la precisión suiza con una fuerte herencia estadounidense, destacándose por su innovación técnica, diseños versátiles y espíritu aventurero. A lo largo de los años ha ganado prestigio en la aviación, el cine y el ámbito militar, creando relojes que equilibran funcionalidad, elegancia y rendimiento. Sus colecciones reflejan un estilo clásico con detalles contemporáneos, convirtiéndose en una referencia para quienes buscan tradición, calidad y carácter relojero.

AARON  JOYEROS

VENTURA

XXL BRIGHT DUNE

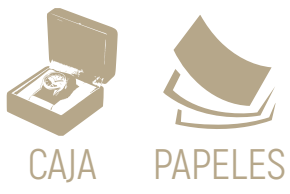

"Limited Edition"

REF. H24614330



- Acero
- 52 mm
- Quartz

PRECIO \$1,700



El Ventura XXL Bright Dune es una edición limitada inspirada en el reloj creado por Dune: Parte Dos, con una esfera azul luminosa que evoca los ojos de los Fremen. Su diseño futurista y detalles inspirados en la película lo convierten en una pieza imprescindible para coleccionistas y fanáticos de la saga.

D U N E

HAMILTON

ÍNDICE

JAZZ MASTER

REF. H895450



-  Acero
-  42 mm
-  Automático



PRECIO 
\$850



AARON  JOYEROS



OBARRIO



HARRY WINSTON

Harry Winston es una prestigiosa casa de lujo reconocida por su excelencia en alta joyería y su incursión en la alta relojería con piezas de gran sofisticación. Sus creaciones destacan por la integración de complicaciones técnicas y el uso excepcional de diamantes y gemas.

AARON  JOYEROS



HARRY WINSTON

PROXIMAMENTE



ORO ROSA

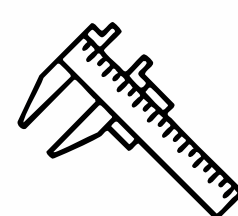

48 mm

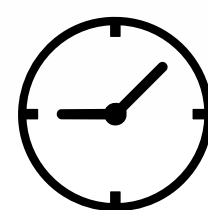

AUTOMÁTICO

PRECIO 
\$120,000

TOURBILLON GLISSIERE



REF. 350-MATRL

PRECIO RETAIL:
\$350,000

CON MANTENIMIENTO DE AGENCIA



OBARRIO



HUBLOT

Hublot es una innovadora manufactura suiza reconocida por su filosofía de "fusión", combinando materiales no convencionales como cerámica, carbono y caucho con la alta relojería tradicional. Sus diseños audaces y contemporáneos han redefinido el concepto de lujo deportivo.

A lo largo de su evolución, la marca ha destacado por su enfoque disruptivo y tecnológico, creando piezas de gran impacto visual y técnico. Hublot representa vanguardia, innovación y una nueva forma de entender la relojería de lujo.

AARON  JOYEROS

H HUBLLOT



KING POWER

UEFA EURO 2012

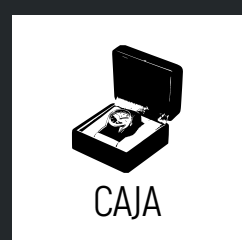

CAJA



OBARRIO



Acero



48 mm



Automático

PRECIO 
\$13,500



REF. 716.NM.1129.RX.EURO12

AARON  JOYEROS

H HUBLOT

KING POWER

ÚNICO



OBARRIO

ORO ROSA



48 mm



AUTOMÁTICO

PRECIO 

\$15,000



REF.

701.OQ.0180.RX



AARON  JOYEROS

BIG BANG



- Acero
- 44 mm
- Automático

PRECIO \$7,500



OBARRIO

REF. 301.SX.130.RX

KING POWER ÚNICO



- Titanio/Diamantes
- 48 mm
- Automático

PRECIO \$20,000



OBARRIO



PAPELES

REF. 701.NX.0170.RX.1740

BIG BANG FERRARI



- Titanio
- 45 mm
- Automático

PRECIO \$15,500



OBARRIO

REF. 401.NQ.0123.VR

KING POWER SAINT BARTH



- Cerámica
- 48 mm
- Automático

PRECIO \$15,000



OBARRIO

REF. HUB4200

BIG BANG RED



- Cerámica
- 44 mm
- Automático

PRECIO \$9,500



CDE

REF. 301.CI.1130.GR.ABR10

BIG BANG



- Carbono
- 45 mm
- Automático

PRECIO \$14,000



OBARRIO



CAJA



PAPELES

REF. 411.YT.1110.NR.IT115

BIG BANG

Titanio/Diamantes

45 mm

Automático

PRECIO
\$12,500



OBARRIO



REF. 4j01.CX.0123.VR

BIG BANG

Cerámica

44 mm

Automático

PRECIO
\$9,000



OBARRIO



CAJA



PAPELES



REF. 301.CT.130.RX

BIG BANG KING POWER

Oro Rosa

48 mm

Automático

PRECIO
\$18,000



OBARRIO



CAJA



PAPELES



REF. 322.PX.100.RX

BIG BANG BI-RETROGRADE

"KING ORO"

Cerámica/Oro Rosa

45 mm

Automático

PRECIO
\$24,200



CDE



REF. 413.OM.1128.RX

KING POWER F1 ABU DHABI

"LIMITED EDITION"

Fibra de Carbón

48 mm

Automático

PRECIO
\$10,000



OBARRIO



CAJA



REF. 719.QM.1729.NR.FAD11

BIG BANG CHRONOGRAPH

Oro Rosa

44 mm

Automático

PRECIO
\$17,500



OBARRIO



REF. 301.PM.1780.RX

BIG BANG JEANS

- Acero
- 44 mm
- Automático

PRECIO 
\$9,800



OBARRIO



REF. 301.SX.2710.NR.JEANS

BIG BANG

- Acero
- 44 mm
- Automático

PRECIO 
\$8,500



OBARRIO



REF. 301.CI.2770.NR

MDN GENEVE

- Oro Amarillo
- 36 mm
- Quartz

PRECIO 
\$6,500



OBARRIO



CAJA



PAPELES



REF. 1512.100.3

MDN TEDDY BEAR

- Acero
- 26 mm
- Quartz

PRECIO 
\$2,000



OBARRIO



CAJA



PAPELES



REF. 1392.999.3

BIG BANG BLACK DIAL

- Cerámica
- 44 mm
- Automático

PRECIO 
\$6,800





OBARRIO



REF. 301.CM.130.RX

BIG BANG KING POWER

-  Acero
-  44 mm
-  Automático

PRECIO 
\$9,500



OBARRIO



REF. 701.CI.1123.GR

BIG BANG

-  Acero
-  38 mm
-  Quartz

PRECIO 
\$7,500





OBARRIO



REF. 361.SX.7170.LR.1204

BIG BANG KING POWER F1

-  Fibra de Carbono
-  48 mm
-  Automático

PRECIO 
\$11,000



OBARRIO



CAJA





PAPELES



REF. 703.QM.1129.HR.FIL11

BIG BANG KING POWER F1

-  Oro Rosa
-  48 mm
-  Automático

PRECIO 
\$21,000



OBARRIO



CAJA



PAPELES



REF. 703.OM.1138.NR.FM010

BIG BANG

-  Oro Rosa/Titanio
-  45 mm
-  Automático

PRECIO 
\$19.500



OBARRIO





CAJA



REF. 614.OX.1180.RX

BIG BANG

-  Oro Rosa
-  41 mm
-  Automático

PRECIO 
\$18,000



OBARRIO



REF. 341.PT.5010.LR.1104

CLASSIC FUSION

- Acero
- 42 mm
- Automático

PRECIO 
\$6,000

-  OBARRIO
-  CAJA
-  PAPELES



REF. 542.NX.1270.RX

CLASSIC FUSION

- Titanio
- 45 mm
- Automático

PRECIO 
\$5,700

-  OBARRIO



REF. 511.NX.1170.LR

BIG BANG

- Acero
- 44 mm
- Automático

PRECIO 
\$7,500

-  OBARRIO



REF. 301SX.1170.RX

CLASSIC FUSION

- Titanio
- 42 mm
- Automático

PRECIO 
\$6,000

-  OBARRIO



REF. 542.NX.8970.RX



IWC

SCHAFFHAUSEN

IWC Schaffhausen es una reconocida manufactura suiza que destaca por su ingeniería de precisión y diseño funcional con influencia técnica. Sus relojes, especialmente en líneas como Pilot's Watches y Portugieser, reflejan un enfoque claro en la legibilidad, la robustez y la elegancia.

A lo largo de su historia, la marca ha combinado tradición relojera con innovación mecánica, consolidándose como referente en relojería técnica. IWC representa precisión, fiabilidad y sofisticación en la alta relojería.

IWC
SCHAFFHAUSEN



REF. IW328202

REF.

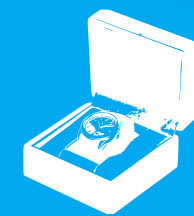

CAJA



PAPELES



OBARRIO

"NUEVO A ESTRENAR"

AVIADOR

MARK XX



Acero



40 mm



Automático

PRECIO





\$5,000

INGENIEUR



REF. IW322504

-  Cerámica
-  46 mm
-  Automático

PRECIO 
\$5,500





OBARRIO

AQUATIMER



REF. IW376709

-  Acero
-  46.6 mm
-  Automático

PRECIO 
\$4,200





OBARRIO

AVIADOR



REF. IW50100

-  Acero
-  46.2 mm
-  Automático

PRECIO 
\$7,000



OBARRIO



CAJA





PAPELES

PORTUGIESER YACHT CLUB



REF. IW390503

-  Acero
-  44 mm
-  Automático

PRECIO 
\$7,800





OBARRIO

AQUATIMER EDICIÓN GALÁPAGOS

"CHARLES DARWING"



REF. IW376705

-  Acero
-  44 mm
-  Automático

PRECIO 
\$4,000



OBARRIO



**JAEGER-LECOULTRE**

Jaeger-LeCoultre es una histórica manufactura suiza reconocida por su excelencia técnica, innovación y dominio en la creación de calibres propios. Sus relojes, como el icónico Reverso, reflejan una perfecta fusión entre ingeniería y elegancia atemporal.

A lo largo de su trayectoria, la marca ha desarrollado numerosas complicaciones y avances en la relojería. Jaeger-LeCoultre representa tradición, precisión y maestría dentro de la alta relojería suiza.

AARON  JOYEROS

JAEGER-LECOULTRE

MASTER CONTROL

ORO ROSA

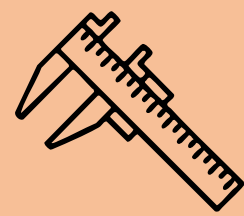

39 mm

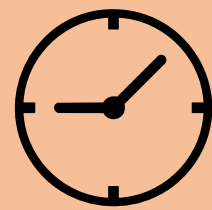

AUTOMÁTICO

PRECIO 
\$16,000



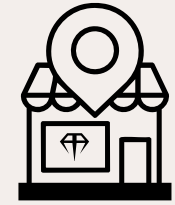

REF. 147.2.41.S



OBARRIO



**MASTER
CALENDAR**

-  Oro Rosa
-  39 mm
-  Automático

PRECIO 
\$14,000





OBARRIO



REF. 176.2.12.S

RENDEZ-VOUS

-  Acero
-  34 mm
-  Automático

PRECIO 
\$7,000



OBARRIO



REF. 344.8.37







LONGINES

Longines es una histórica casa suiza destacada por su elegancia, precisión y tradición relojera. Sus diseños reflejan un estilo clásico y atemporal que ha perdurado a lo largo del tiempo.

Longines representa fiabilidad, refinamiento y herencia dentro de la relojería suiza.

AARON  JOYEROS

CONQUEST

-  Acero
-  44.5 mm
-  Automático

PRECIO 
\$2,000





OBARRIO



REF. L3.697.4

VINTAGE

-  Oro Amarillo
-  24 mm
-  Automático

PRECIO 
\$9,400



CDE



CAJA





PAPELES



REF. 26310R.00

LEGEND DIVER

-  Acero
-  42 mm
-  Automático

PRECIO 
\$2,200





OBARRIO



REF. L3.774.4.50.9

EVIDENZA

-  Acero
-  38.75 mm
-  Automático

PRECIO 
\$1,500





OBARRIO



REF. L2.642.4.51.6

SAINT-IMIER

-  Oro
-  36.8 mm
-  Automático

PRECIO 
\$5,600





OBARRIO



REF. L.989.2

MASTER COLLECTION

"Pulso Aftermarket"

-  Acero
-  42 mm
-  Automático

PRECIO 
\$1,600



OBARRIO



REF. L26664783



**MONT
BLANC** 

Montblanc es una distinguida casa de lujo que ha incursionado en la alta relojería combinando precisión suiza con diseño elegante y contemporáneo. Sus relojes reflejan un equilibrio entre tradición, innovación y estética refinada.

Montblanc representa sofisticación, funcionalidad y una visión moderna dentro del universo relojero.

AARON  JOYEROS

MONT
BLANC

TIMEWALKER



ACERO



43 mm



AUTOMÁTICO

PRECIO



\$2,200



REF.

7069



OBARRIO

AARON  JOYEROS

PRINCESS GRACE DE MÓNACO



-  Acero
-  34 mm
-  Quartz

PRECIO 
\$1,500



REF. 106884

TIMEWALKER



-  Acero
-  39 mm
-  Automático

PRECIO 
\$1,800



REF. 7308

MONTBLANC



-  Acero
-  41 mm
-  Automático

PRECIO 
\$3,500



REF. 7383

TIMEWALKER



-  Acero
-  42 mm
-  Automático

PRECIO 
\$1,200



REF. 7070

TIMEWALKER

-  Acero
-  42 mm
-  Automático

PRECIO 
\$1,500



REF. 4810

STAR



-  Acero
-  40 mm
-  Quartz

PRECIO 
\$1,400



REF. MB104182

TIMEWALKER OROLOGIO

-  Acero
-  43 mm
-  Automático

PRECIO 
\$1,600





OBARRIO



REF. 0969

MEINSTERSTUCK

-  Acero
-  42 mm
-  Automático

PRECIO 
\$1,500



OBARRIO





CAJA



REF. 7070

MEINSTERSTUCK

-  Acero
-  43 mm
-  Automático

PRECIO 
\$2,000



OBARRIO



REF. 7141

STUCK

-  Acero
-  36 mm
-  Quartz

PRECIO 
\$1,200





OBARRIO



REF. 7038

TIMEWALKER GMT

-  Acero
-  42 mm
-  Automático

PRECIO 
\$2,000





OBARRIO



REF. 7081

STAR

-  Acero
-  42 mm
-  Automático

PRECIO 
\$2,500



OBARRIO



REF. 110642

MONTBLANC

- Acero
- 41 mm
- Automático

PRECIO \$
\$1,500



OBARRIO



REF. 4810



MONTBLANC

1858

- Acero
- 42 mm
- Automático

PRECIO \$
\$2,200



OBARRIO



CAJA



PAPELES



REF. 1858



SPORT

- Acero
- 41 mm
- Automático

PRECIO \$
\$1,500



OBARRIO



REF. 7034





MAURICE LACROIX

Manufacture Horlogère Suisse

Maurice Lacroix es una casa suiza que destaca por su enfoque en el diseño contemporáneo y la innovación accesible dentro de la relojería. Sus creaciones combinan precisión, estética moderna y un fuerte carácter visual.

Maurice Lacroix representa creatividad, dinamismo y una propuesta actual en la relojería suiza.



ORO AMARILLO

 46 mm

 AUTOMÁTICO

PRECIO 
\$19,000

 OBARRIO

MASTERPIECE

REF.  MP7281





MASTERPIECE

ORO AMARILLO 18K

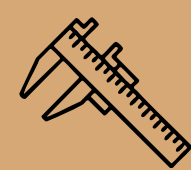

40 mm



AUTOMÁTICO

PRECIO 
\$17,000



OBARRIO

REF.

MP6388



Ω OMEGA

Omega es una prestigiosa marca suiza de relojería fundada en 1848, reconocida por su precisión, innovación y fuerte legado histórico. Es famosa por hitos como el Apollo 11 Moon Landing, donde su modelo Speedmaster fue el primer reloj en la Luna, y por ser cronómetro oficial de los Juegos Olímpicos.

Hoy, Omega representa lujo, tecnología avanzada y diseño icónico dentro de la alta relojería.

Ω
OMEGA

SEAMASTER

PLANET OCEAN 600M



Titanio



42 mm



Automático

PRECIO



\$5,600



OBARRIO



CAJA



PAPELES

AARON JOYEROS

REF. 232.90.42.21.03.001

SEAMASTER

DIVER 300M



Acero



41.5 mm



Automático

PRECIO



\$3,500



OBARRIO

REF. 213.30.42.40.01.001



45.5 mm



AUTOMÁTICO



OBARRIO

SEAMASTER

PRECIO 
\$8,000

TITANIO

REF. 215.90.46.51.99.001



CAJA





PAPELES



SEAMASTER	SPEEDMASTER	CONSTELLATION	DE VILLE	DYNAMIC
-----------	-------------	---------------	----------	---------

SEAMASTER PLANET OCEAN

"PANAMA CANAL"

-  Acero
-  45.5 mm
-  Automático

PRECIO 
\$6,000





OBARRIO



REF. 232.30.46.21.01.005



SEAMASTER PLANET OCEAN

-  Cerámica
-  45.5 mm
-  Automático

PRECIO 
\$8,500





OBARRIO



REF. 215.92.22.01.004



SEAMASTER 300

-  Acero
-  45.5 mm
-  Automático

PRECIO 
\$5,800

OBARRIO



REF. 234.30.41.21.03.001



SEAMASTER SPEEDMASTER CONSTELLATION DE VILLE DYNAMIC

SEAMASTER AQUA TERRA

- Acero
- 43 mm
- Automático

PRECIO
\$4,500



REF. 231.10.44.50.02.001

SEAMASTER PLANET OCEAN 600M

- Acero
- 43.5 mm
- Automático

PRECIO
\$5,000



REF. 232.30.44.22.01.001

SEAMASTER

- Quartz
- 36 mm
- Quartz

PRECIO
\$2,000



REF. 2561.80.00

SEAMASTER 300M

- Acero
- 36 mm
- Automático

PRECIO
\$2,600



REF. 22228000

SEAMASTER

- Acero
- 36 mm
- Quartz

PRECIO
\$2,000



REF. 2561.80.00

SEAMASTER

- Acero
- 36 mm
- Quartz



PRECIO
\$2,000



REF. 2561.80.00

SEAMASTER	SPEEDMASTER	CONSTELLATION	DE VILLE	DYNAMIC
-----------	-------------	---------------	----------	---------

SPEEDMASTER MOONPHASE

-  Acero
-  44.2 mm
-  Automático

PRECIO 
\$8,500



REF. 304.33.44.52.03.001

SPEEDMASTER



-  Cerámica/Nato
-  42.2 mm
-  Automático

PRECIO 
\$8,500



REF. 311.92.44.51.01.007

SPEEDMASTER

-  Acero
-  39 mm
-  Automático

PRECIO 
\$3,000



REF. 3520.50.00

SEAMASTER	SPEEDMASTER	CONSTELLATION	DE VILLE	DYNAMIC
-----------	-------------	---------------	----------	---------

CONSTELLATION

 Acero / Oro Rosa

 35 mm

 Automático

PRECIO 
\$6,500

 OBARRIO  CAJA  PAPELES



REF. 123.20.35.20.63.001

CONSTELLATION BICOLOR

 Acero y Oro

 38 mm

 Automático

PRECIO 
\$8,000

 OBARRIO  CAJA  PAPELES



REF. 123.20.38.21.03.001

CONSTELLATION BICOLOR

 Acero y Oro

 34 mm

 Quartz

PRECIO 
\$2,500

 OBARRIO



REF. 55296372

CONSTELLATION MOTHER OF PEARL

 Acero y Oro

 24 mm

 Quartz

PRECIO 
\$1,800

 CDE



REF. 795.1203

CONSTELLATION

 Acero / Oro

 29 mm

 Automático

PRECIO 
\$9,800

 OBARRIO



REF. 131.20.29.20.05.002

CONSTELLATION

 Acero / Oro

 35.5 mm

 Quartz

PRECIO 
\$2,800

 OBARRIO



REF. 1302.30.00

SEAMASTER	SPEEDMASTER	CONSTELLATION	DE VILLE	DYNAMIC
-----------	-------------	---------------	----------	---------

CONSTELLATION QUADRA

"DIAL MADRE PERLA"

-  Acero
-  24 X 19.3 mm
-  Quartz

PRECIO 
\$1,400



OBARRIO



REF. 1521.7100

CONSTELLATION

-  Acero
-  27 mm
-  Quartz

PRECIO 
\$2,500



OBARRIO



CAJA





PAPELES



REF. 123.10.27.60.02.002

CONSTELLATION QUADRA DIAMOND

-  Acero / Diamante
-  19 mm
-  Quartz

PRECIO 
\$2,000



OBARRIO



REF. 1528.76.00

CONSTELLATION

-  Acero / Oro
-  26 mm
-  Quartz

PRECIO 
\$3,200



OBARRIO



REF. 1277

CONSTELLATION QUADRA DIAMOND

-  Acero
-  19 mm
-  Quartz

PRECIO 
\$1,200



OBARRIO





REF. 1528.76.00

SEAMASTER SPEEDMASTER CONSTELLATION DE VILLE DYNAMIC

DEVILLE VINTAGE

"BISEL DE DIAMANTES"

 Oro Blanco

 25.4 mm

 Quartz

PRECIO 
\$8,000



OBARRIO



REF. VINTAGE

DE VILLE

 Acero

 41 mm

 Automático

PRECIO 
\$3,500



OBARRIO



CAJA



REF. 424.10.37.20.03.001

DE VILLE PRESTIGE

 Acero

 39.5 mm

 Automático

PRECIO 
\$3,500



OBARRIO



CAJA



REF. 424.13.40.20.06.002

DE VILLE

 Acero / Oro Ama.

 36.8 mm

 Automático

PRECIO 
\$4,000



OBARRIO



REF. 424.20.37.20.02.001

DE VILLE

 Oro Amarillo

 31 mm

 Quartz

PRECIO 
\$4,000



OBARRIO



REF. VINTAGE

DE VILLE

"UFO"

 Acero

 40 mm

 Automático

PRECIO 
\$1,200



OBARRIO



REF. 166.094

SEAMASTER

SPEEDMASTER

CONSTELLATION

DE VILLE

DYNAMIC

DYNAMIC

 Acero

 42 mm

 Automático

PRECIO 

\$1,200



OBARRIO



REF. 136.033





ORIS

HÖLSTEIN 1904

Oris es una marca suiza independiente fundada en 1904, reconocida por su enfoque en relojes mecánicos accesibles. Especializada exclusivamente en movimientos automáticos.

Oris ha ganado notoriedad por desarrollar calibres propios como la serie Calibre 400 con alta reserva de marcha. La marca mantiene una filosofía de "lujo funcional", priorizando utilidad sobre ostentación.

BIG CROWN POINTER DAY



ACERO

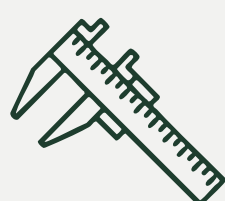

44 mm

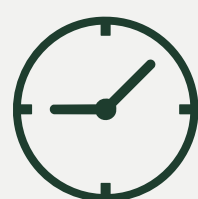

AUTOMÁTICO

PRECIO 
\$1,600

REF.

7629-40



OBARRIO





REGULATEUR

DER MEISTERTAUCHER

TITANIO



49 mm



AUTOMÁTICO



OBARRIO



CAJA



PAPELES

PRECIO 

\$1,500

REF.

01 649 7610





PANERAI

Panerai es una distintiva casa de relojería con raíces italianas y desarrollo suizo, reconocida por su diseño robusto y estética inconfundible. Sus relojes, inspirados en instrumentos militares y de buceo, destacan por cajas imponentes y alta legibilidad.

A lo largo de su historia, la marca ha combinado ingeniería técnica con un estilo único. Panerai representa carácter, herencia y presencia dentro de la relojería de lujo.

FERRARI CRONÓGRAFO

-  Acero
-  45 mm
-  Automático



PRECIO 
\$6,500

-  OBARRIO
-  CAJA
-  PAPELES



REF. FER00004

FERRARI CRONÓGRAFO

-  Acero
-  45 mm
-  Automático



PRECIO 
\$6,500

-  CDE



REF. FER00005

MARINA MILITARE

-  Acero
-  47 mm
-  Automático

PRECIO 
\$9,500

-  OBARRIO
-  CAJA
-  PAPELES



REF. PAM673

RADIOMIR BLACK SEAL

-  Acero
-  45 mm
-  Cuerda Manual



PRECIO 
\$4,200

-  OBARRIO



REF. PAM00183

LUMINOR BLACK SEAL

-  Acero
-  47 mm
-  Automático

PRECIO 
\$5,500

-  OBARRIO



REF. PAM0514

LUMINOR

-  Acero
-  44 mm
-  Cuerda Manual



PRECIO 
\$3,900

-  OBARRIO



REF. PAM112

LUMINOR RATTRAPANTE



-  Acero
-  44 mm
-  Automático

PRECIO 
\$7,300



REF. PAM00213

RADIOMIR MILITARE



-  Cerámica
-  47 mm
-  Automático

PRECIO 
\$9,000



REF. PAM00339

LUMINOR



-  Acero
-  44 mm
-  Automático

PRECIO 
\$4,400



REF. OP6728

LUMINOR SUMERSIBLE



-  Acero
-  47 mm
-  Automático

PRECIO 
\$7,000



REF. PAM00305

SUBMERSIBLE



-  Acero
-  42 mm
-  Automático

PRECIO 
\$7,500



REF. PAM00959

LUMINOR

-  Acero / Caucho
-  47 mm
-  Automático

PRECIO 
\$6,000



REF. PAM372



CHARRIOL
GENEVE

Philippe Charriol es una firma de lujo reconocida por su enfoque distintivo en el diseño, inspirado en formas y trenzados característicos. Sus relojes combinan elegancia, creatividad y una identidad visual única dentro del mundo relojero.

A lo largo de su trayectoria, la marca ha desarrollado piezas con fuerte personalidad estética representando estilo, originalidad y sofisticación contemporánea.

AARON  **JOYEROS**

CHARRIOL

 Acero/Baño de Oro

 33.5 mm

 Quartz

PRECIO 

\$1,000



OBARRIO



REF. 53.98.3797





PIAGET

Philippe Charriol es una firma de lujo reconocida por su enfoque distintivo en el diseño, inspirado en formas y trenzados característicos. Sus relojes combinan elegancia, creatividad y una identidad visual única dentro del mundo relojero.

A lo largo de su trayectoria, la marca ha desarrollado piezas con fuerte personalidad estética. Philippe Charriol representa estilo, originalidad y sofisticación contemporánea.

POSSESSION

 Oro Blanco

 28 mm

 Quartz

PRECIO 
\$5,000



OBARRIO



CAJA



PAPELES



REF. 1009275

ALTIPLANO CLOUS DE PARÍS

 Oro 18 k

 26 mm

 Cuerda Manual

PRECIO 
\$4,000



OBARRIO



REF. 549551

HABANA

CUERVOS Y SOBRINOS

 Acero y Oro Ama.

 33 mm

 Cuerda Manual

PRECIO 
\$700



OBARRIO





REF. 26310R.00

MISS PROTOCOLE

XL

 Bisel/Diamante

 40 x 36 mm

 Quartz

PRECIO 
\$8,500



CDE



REF. P10206

POLO

 Oro y Diamantes

 34 mm

 Automático

PRECIO 
\$20,000



OBARRIO



REF. 24005 M 501 D

RECTANGLE

L'ANTIGUA XL

 Oro Rosa

 31 X 46 mm

 Automático

PRECIO 
\$15,200



CDE



REF. PI0076

TANAGRA

 Oro Amarillo

 24 mm

 Quartz

PRECIO 
\$11,850



CDE



REF. 16033





RW
RAYMOND WEIL
GENEVE

Raymond Weil es una reconocida casa suiza que destaca por su elegancia accesible y su inspiración en la música y las artes. Sus relojes combinan diseño clásico, precisión y un enfoque estético refinado.

A lo largo de su trayectoria, la marca ha creado colecciones con fuerte identidad cultural. Raymond Weil representa armonía, tradición y estilo dentro de la relojería suiza.

ELECTROPLATED
 VINTAGE

-  Baño de Oro
-  28 mm
-  Quartz

PRECIO 
 \$500





OBARRIO



REF. 9022

NABUCCO

-  Acero
-  44 mm
-  Automático

PRECIO 
 \$600



OBARRIO





CAJA



REF. 3900

DON GIOVANNI
 COSI GRANDE

-  Acero
-  29.5 x 31 mm
-  Quartz

PRECIO 
 \$1,200



OBARRIO



REF. 2671-ST-00209

TOCCATA
 CLASSIC

-  Acero
-  42 mm
-  Quartz

PRECIO 
 \$900



OBARRIO



CAJA



PAPELES



REF. 5585-ST-60001

TANGO

-  Acero
-  41 mm
-  Quartz

PRECIO 
 \$750



OBARRIO



REF. 8260-ST7-20001







REVIEW THOMMEN
Since 1853

La línea de Revue Thommen refleja una sólida tradición relojera suiza, enfocada en la precisión y la funcionalidad. Sus diseños equilibran lo clásico y lo deportivo, con una estética sobria y versátil.

Con una historia ligada también a la aviación y a instrumentos de medición, la marca transmite fiabilidad técnica en cada pieza. Es una opción atractiva para quienes buscan relojes mecánicos bien contruidos, elegantes y con carácter histórico.

REVUE THOMMEN

-  Acero
-  40 mm
-  Automático

PRECIO 
\$1,000

-  CDE
-  CAJA
-  PAPELES



REF. 7001.6





ROGER DUBUIS

Roger Dubuis es una audaz manufactura suiza de alta relojería, reconocida por su diseño vanguardista y complejidad mecánica. Sus relojes destacan por esqueletizados extremos, arquitectura contemporánea y acabados de alto nivel.

A lo largo de su evolución, la marca ha llevado la relojería a un terreno más expresivo y disruptivo. Roger Dubuis representa innovación, exclusividad y una visión radical del lujo relojero.



ROGER DUBUIS



PULSION

ORO ROSA

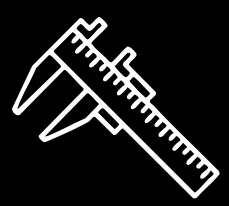

44 mm

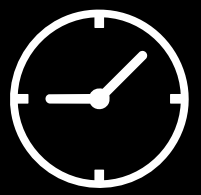

AUTOMÁTICO

PRECIO 
\$25,000

PRECIO RETAIL:
\$43,900

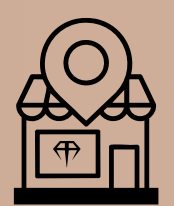

OBARRIO

REF.

RDDDBPU003

AARON  JOYEROS



ROLEX

Rolex es una de las marcas más reconocidas de la alta relojería, famosa por su precisión, durabilidad y diseño atemporal. Sus colecciones combinan innovación técnica con elegancia, convirtiéndose en símbolo de éxito, prestigio y rendimiento en cualquier entorno.

AARON  JOYEROS

AIR KING	DAYTONA	DATEJUST	DAY-DATE	EXPLORER	GMT-MASTER	MILGAUSS
OYSTER PERPETUAL	SEA-DWELLER	SKY-DWELLER	SUBMARINER	YACHT-MASTER	CELLINI	ORCHID

AIR KING



-  Acero
-  34 mm
-  Automático

 CDE

PRECIO 

\$4,000

"AFTERMARKET DIAL" REF.

AIR KING	DAYTONA	DATEJUST	DAY-DATE	EXPLORER	GMT-MASTER	MILGAUSS
OYSTER PERPETUAL	SEA-DWELLER	SKY-DWELLER	SUBMARINER	YACHT-MASTER	CELLINI	ORCHID

AIRKING PRECISION



-  Acero
-  34 mm
-  Automático

PRECIO 
 \$4,800





ROLEX



DAYTONA

La línea Daytona es un icono de la relojería deportiva, creada para el automovilismo y la medición precisa del tiempo. Con su característico bisel taquimétrico y diseño elegante, combina alto rendimiento con lujo, consolidándose como uno de los modelos más deseados de Rolex.

ROLEX

DAYTONA
COSMOGRAPH

DAYTONA
JOHN MAYER



OBARRIO

-  Oro Amarillo
-  40 mm
-  Automático

PRECIO 
\$75,000

REF. 116508

AARON  JOYEROS

ROLEX

DAYTONA

COSMOGRAPH

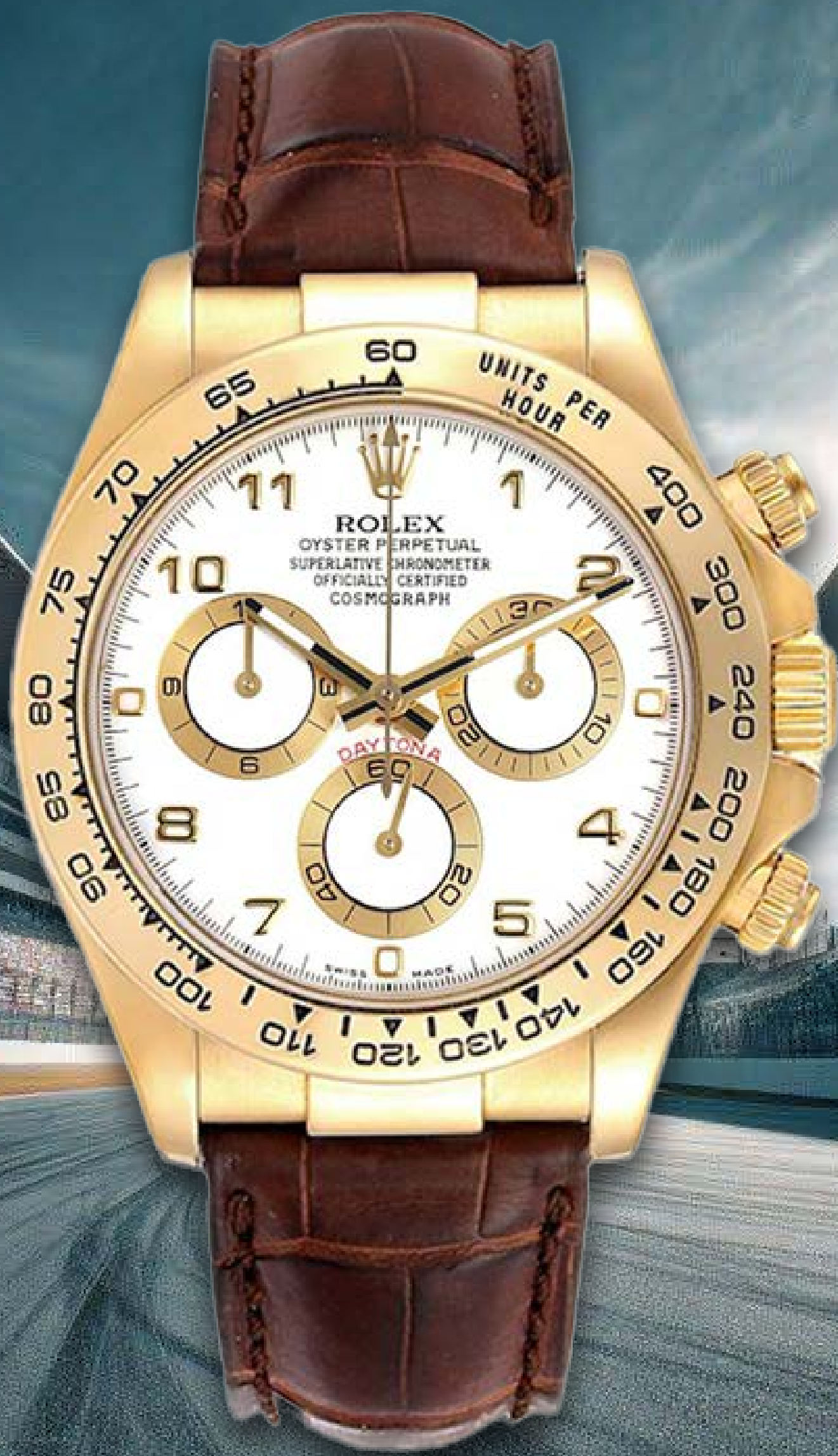

COSTA DEL
ESTE



ORO



40 mm



AUTOMÁTICO

PRECIO



\$35,000

116518

REF.

AARON  JOYEROS

AIR KING	DAYTONA	DATEJUST	DAY-DATE	EXPLORER	GMT-MASTER	MILGAUSS
OYSTER PERPETUAL	SEA-DWELLER	SKY-DWELLER	SUBMARINER	YACHT-MASTER	CELLINI	ORCHID

DAYTONA
COSMOGRAPH



REF. 116520

- Acero
- 40 mm
- Automático

PRECIO \$24,000

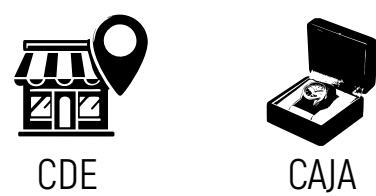

DAYTONA

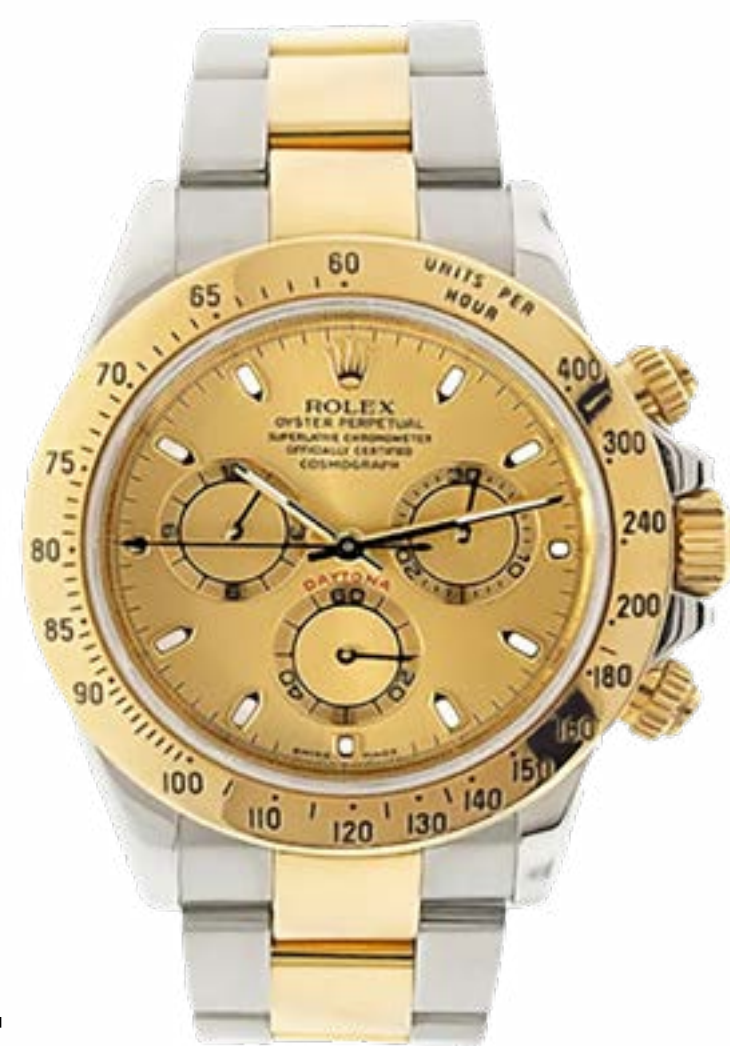

REF. 116523

- Acero / Oro
- 40 mm
- Automático

PRECIO \$21,000

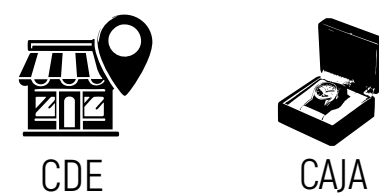

DAYTONA

"INVERTED 6"



REF. 16523

- Acero / Oro
- 40 mm
- Automático

PRECIO \$22,000



DAYTONA



REF. 116528

- Oro
- 40 mm
- Automático

PRECIO \$35,000



DAYTONA
OYSTER FLEX



REF. 16518

- Oro
- 40 mm
- Automático

PRECIO \$30,000



DAYTONA

"MOVIMIENTO ZENITH"



REF. 16523

- Acero / Oro
- 40 mm
- Automático

PRECIO \$19,500





AIR KING	DAYTONA	DATEJUST	DAY-DATE	EXPLORER	GMT-MASTER	MILGAUSS
OYSTER PERPETUAL	SEA-DWELLER	SKY-DWELLER	SUBMARINER	YACHT-MASTER	CELLINI	ORCHID

DAYTONA



REF. 116520

-  Acero
-  40 mm
-  Automático

PRECIO 
\$23,000





OBARRIO CAJA

DAYTONA



REF. 116509

-  Oro Blanco
-  40 mm
-  Automático

PRECIO 
\$35,000





OBARRIO CAJA PAPELES

DAYTONA



REF. 116520

-  Acero
-  40 mm
-  Automático

PRECIO 
\$22,500





OBARRIO CAJA

DAYTONA



REF. 116520

-  Acero
-  40 mm
-  Automático

PRECIO 
\$23,000



OBARRIO



WIMBLEDON



REF. 126303



WIMBLEDON

-  Acero / Oro
-  41 mm
-  Automático

PRECIO 
\$15,500



AIR KING	DAYTONA	DATEJUST	DAY-DATE	EXPLORER	GMT-MASTER	MILGAUSS
OYSTER PERPETUAL	SEA-DWELLER	SKY-DWELLER	SUBMARINER	YACHT-MASTER	CELLINI	ORCHID

DATEJUST WIMBLEDON



REF. 116333

- Acero / Oro
- 41 mm
- Automático

PRECIO \$13,500



OBARRIO

DATEJUST WIMBLEDON



REF. 116333

- Acero / Oro
- 41 mm
- Automático

PRECIO \$13,800



OBARRIO



PAPELES

DATEJUST WIMBLEDON



REF. 126333

- Acero / Oro
- 41 mm
- Automático

PRECIO \$14,000



OBARRIO



PAPELES



DATEJUST WIMBLEDON

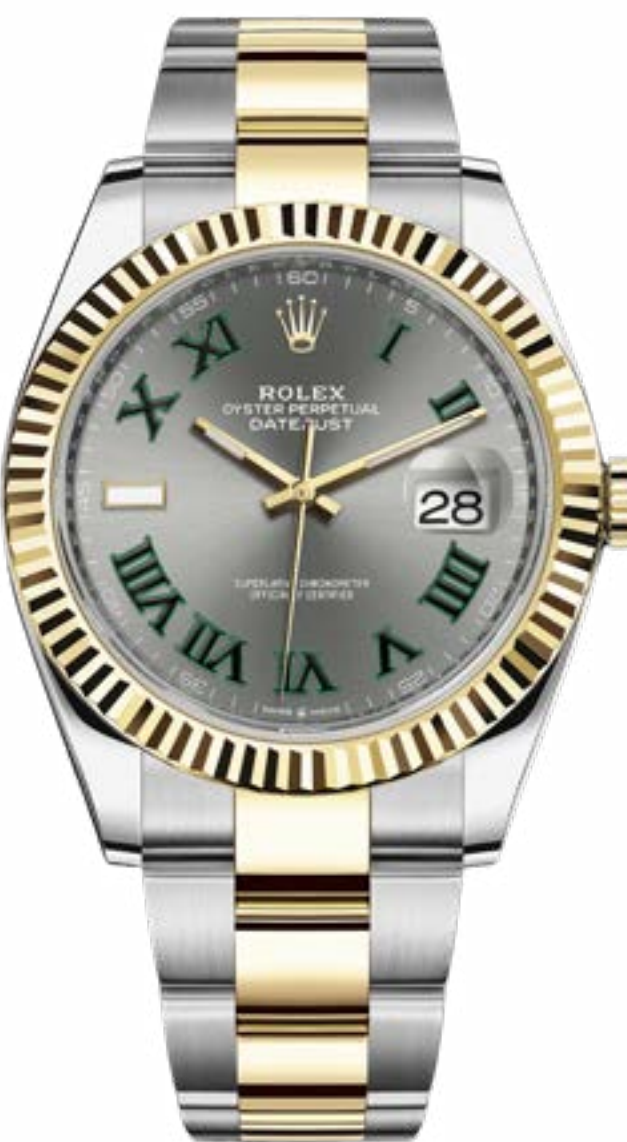

REF. 126333

- Acero / Oro
- 41 mm
- Automático

PRECIO \$16,500



OBARRIO



CAJA



PAPELES



DATEJUST PEARLMASTER



-  Oro Rosa
-  34 mm
-  Automático

PRECIO 
\$37,000

"FONDO MADRE PERRLA"



CAJA



PAPELES

REF.

81315



OBARRIO

AIR KING	DAYTONA	DATEJUST	DAY-DATE	EXPLORER	GMT-MASTER	MILGAUSS
OYSTER PERPETUAL	SEA-DWELLER	SKY-DWELLER	SUBMARINER	YACHT-MASTER	CELLINI	ORCHID

DATEJUST

"BISEL DE ORO"

- Acero / Oro
- 41 mm
- Automático

PRECIO
\$11,000



CDE



REF. 116334

DATEJUST

"BISEL DE ORO"

- Acero / Oro
- 41 mm
- Automático

PRECIO
\$11,000



OBARRIO



REF. 116334

DATEJUST

- Acero / Oro
- 41 mm
- Automático

PRECIO
\$11,000



OBARRIO



REF. 116334

DATEJUST

- Acero
- 41 mm
- Automático

PRECIO
\$10,000



OBARRIO



REF. 126300

DATEJUST

- Acero / Oro
- 41 mm
- Automático

PRECIO
\$13,000



OBARRIO



CAJA



REF. 126334

DATEJUST

- Oro
- 36 mm
- Automático

PRECIO
\$12,000



OBARRIO



REF. 116139

AIR KING	DAYTONA	DATEJUST	DAY-DATE	EXPLORER	GMT-MASTER	MILGAUSS
OYSTER PERPETUAL	SEA-DWELLER	SKY-DWELLER	SUBMARINER	YACHT-MASTER	CELLINI	ORCHID

DATEJUST

- Acero
- 41 mm
- Automático

PRECIO \$9,500



OBARRIO



REF. 116300

DATEJUST

- Acero / Oro
- 41 mm
- Automático

PRECIO \$15,500



CDE



CAJA



PAPELES



REF. 126334

DATEJUST

- Acero
- 36 mm
- Automático

PRECIO \$7,800



OBARRIO



REF. 116200

DATEJUST

- Acero
- 41 mm
- Automático

PRECIO \$10,500



OBARRIO



CAJA



PAPELES



REF. 116300

DATEJUST

- Acero
- 36 mm
- Automático

PRECIO \$8,650



CDE



CAJA



PAPELES



REF. 116200

DATEJUST

- Acero
- 31 mm
- Automático

PRECIO \$8,500



OBARRIO



CAJA





PAPELES



REF. 124200

AIR KING	DAYTONA	DATEJUST	DAY-DATE	EXPLORER	GMT-MASTER	MILGAUSS
OYSTER PERPETUAL	SEA-DWELLER	SKY-DWELLER	SUBMARINER	YACHT-MASTER	CELLINI	ORCHID

DATEJUST

-  Acero
-  41 mm
-  Automático

PRECIO 
\$9,500





OBARRIO



REF. 116300

DATEJUST

"BISEL DE ORO BLANCO"

-  Acero / Oro
-  41 mm
-  Automático

PRECIO 
\$11,000





OBARRIO



REF. 116334

DATEJUST

-  Acero / Oro
-  41 mm
-  Automático

PRECIO 
\$10,500





OBARRIO



REF. 116334

DATEJUST

-  Acero / Oro
-  41 mm
-  Automático

PRECIO 
\$11,000





OBARRIO



REF. 116334

DATEJUST

-  Acero
-  41 mm
-  Automático

PRECIO 
\$11,500





OBARRIO



REF. 116300

DATEJUST

-  Acero / Oro
-  41 mm
-  Automático

PRECIO 
\$10,800





OBARRIO



REF. 116334

AIR KING	DAYTONA	DATEJUST	DAY-DATE	EXPLORER	GMT-MASTER	MILGAUSS
OYSTER PERPETUAL	SEA-DWELLER	SKY-DWELLER	SUBMARINER	YACHT-MASTER	CELLINI	ORCHID

DATEJUST

-  Acero
-  36 mm
-  Automático

PRECIO 
\$6,200





OBARRIO



REF. 16220

DATEJUST PEARL MASTER

"DIAL MADRE PERLA"

-  Oro/Diamantes
-  29 mm
-  Automático

PRECIO 
\$20,000





OBARRIO



REF. 80299

DATEJUST

-  Acero / Oro
-  41 mm
-  Automático

PRECIO 
\$12,000



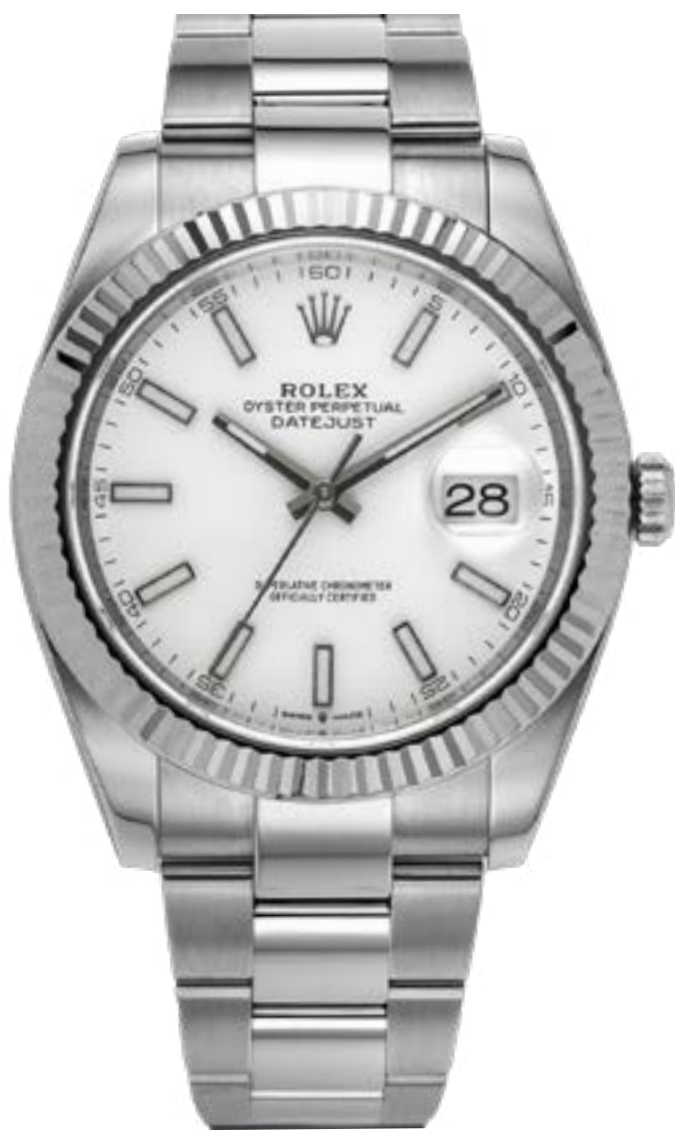

OBARRIO



REF. 126334

DATEJUST

-  Acero
-  36 mm
-  Automático

PRECIO 
\$6,500





OBARRIO



REF. 16030

DATEJUST

-  Acero / Oro
-  41 mm
-  Automático

PRECIO 
\$11,000





OBARRIO



REF. 116334

DATEJUST

-  Acero
-  36 mm
-  Automático

PRECIO 
\$5,800



OBARRIO



REF. 116234

AIR KING	DAYTONA	DATEJUST	DAY-DATE	EXPLORER	GMT-MASTER	MILGAUSS
OYSTER PERPETUAL	SEA-DWELLER	SKY-DWELLER	SUBMARINER	YACHT-MASTER	CELLINI	ORCHID

DATEJUST

 Oro Amarillo

 36 mm

 Automático

PRECIO 
\$15,500



OBARRIO



REF. 6605

DATEJUST

"DIAL MADRE PERLA"

 Oro / Diamantes

 29 mm

 Automático

PRECIO 
\$30,000



CDE



REF. 80318

DATEJUST

 Oro

 31 mm

 Automático

PRECIO 
\$14,000



OBARRIO



REF. 6827

DATEJUST

"PULSO NO ORIGINAL DE PLATA"

 Caja de Oro

 36 mm

 Automático

PRECIO 
\$8,500



OBARRIO



REF. 16018

DATEJUST

 Acero / Oro

 26 mm

 Automático

PRECIO 
\$4,500



OBARRIO



REF. 6917

DATEJUST

 Acero / Oro / Dia.

 41 mm

 Automático

PRECIO 
\$14,000



OBARRIO



CAJA



PAPELES

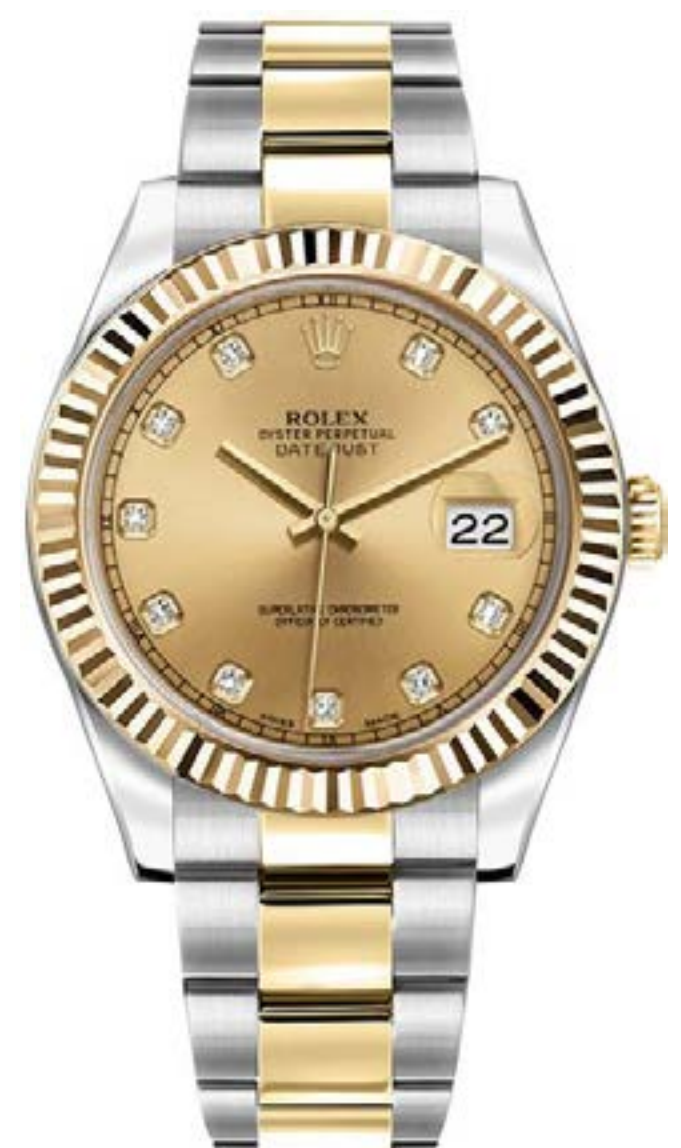



REF. 116333

AIR KING	DAYTONA	DATEJUST	DAY-DATE	EXPLORER	GMT-MASTER	MILGAUSS
OYSTER PERPETUAL	SEA-DWELLER	SKY-DWELLER	SUBMARINER	YACHT-MASTER	CELLINI	ORCHID

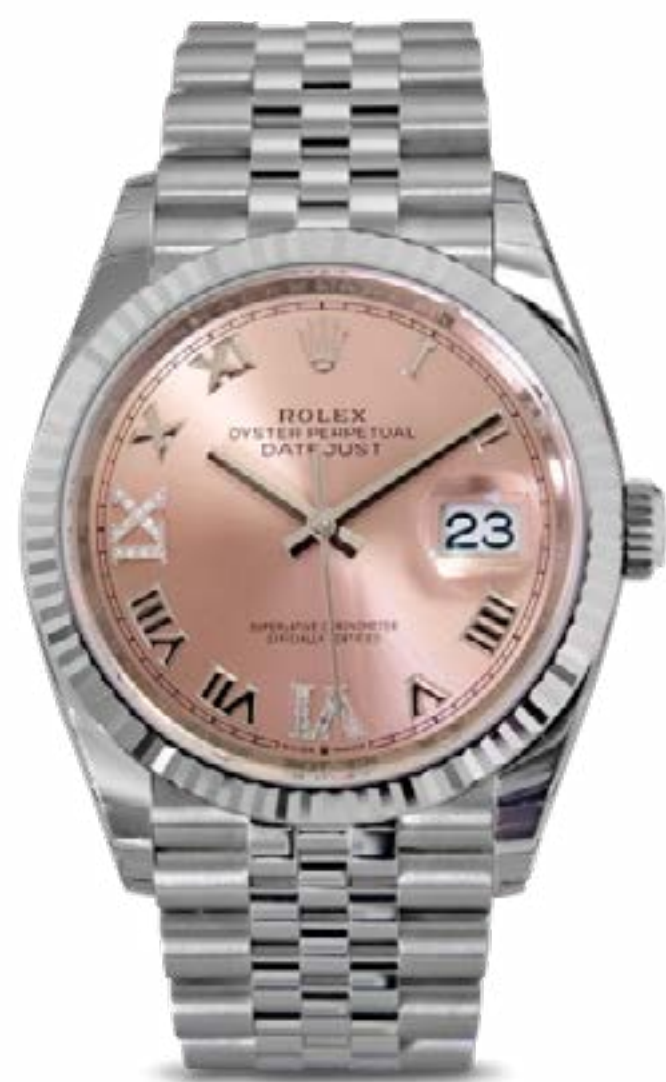
DATEJUST



REF. 126234

-  Acero / Oro
-  36 mm
-  Automático

PRECIO 
\$16,500



-  OBARRIO
-  CAJA
-  PAPELES

DATEJUST

"PEARLMASTER"



REF. 179174

-  Acero
-  26 mm
-  Automático



PRECIO 
\$9,500

-  CDE
-  PAPELES

DATEJUST



REF. 278240

-  Acero
-  31 mm
-  Automático

PRECIO 
\$10,500



-  CDE
-  CAJA
-  PAPELES

DATEJUST

"BISEL & DIAL AFTERMARKET"



REF. 126300

-  Acero/Diamantes
-  41 mm
-  Automático



PRECIO 
\$12,000

-  OBARRIO

DATEJUST



REF. 179165

-  Oro Rosa
-  26 mm
-  Automático



PRECIO 
\$15,000

-  OBARRIO

DATEJUST



REF. 179165

-  Oro Rosa
-  26 mm
-  Automático

PRECIO 
\$15,000

-  CDE

AIR KING	DAYTONA	DATEJUST	DAY-DATE	EXPLORER	GMT-MASTER	MILGAUSS
OYSTER PERPETUAL	SEA-DWELLER	SKY-DWELLER	SUBMARINER	YACHT-MASTER	CELLINI	ORCHID

DATEJUST



-  Acero y Oro
-  26 mm
-  Automático

PRECIO 
\$4,800



REF. 69173

DATEJUST



-  Acero / Oro
-  41 mm
-  Automático

PRECIO 
\$16,500



REF. 126303

DATE



-  Oro Amarillo
-  34 mm
-  Automático

PRECIO 
\$20,000



REF. 1500

DATEJUST



-  Acero / Oro Rosa
-  41 mm
-  Automático

PRECIO 
\$14,000



REF. 126301

DATEJUST



-  Oro
-  29 mm
-  Automático

PRECIO 
\$24,000



REF. 80298

DATEJUST

-  Oro Amarillo
-  36 mm
-  Automático

PRECIO 
\$15,000



REF. 1601

AIR KING	DAYTONA	DATEJUST	DAY-DATE	EXPLORER	GMT-MASTER	MILGAUSS
OYSTER PERPETUAL	SEA-DWELLER	SKY-DWELLER	SUBMARINER	YACHT-MASTER	CELLINI	ORCHID

DATEJUST

- Acero
- 26 mm
- Automático

PRECIO \$5,000

- OBARRIO
- CAJA
- PAPELES



REF. 79160

DATEJUST

- Acero / Oro
- 36 mm
- Automático

PRECIO \$6,500

- OBARRIO



REF. 16013

DATEJUST

"BISEL DE ORO BLANCO"

- Acero / Oro
- 41 mm
- Automático

PRECIO \$11,500

- OBARRIO



REF. 116334

DATEJUST

"BISEL DE ORO BLANCO"

- Acero / Oro
- 41 mm
- Automático

PRECIO \$11,500

- OBARRIO



REF. 116334

DATEJUST

- Acero / Oro
- 31 mm
- Automático

PRECIO \$17,000

- OBARRIO
- PAPELES



REF. 178313

DATEJUST

- Acero / Oro
- 26 mm
- Automático

PRECIO \$5,500

- OBARRIO
- PAPELES



REF. 69173

AIR KING	DAYTONA	DATEJUST	DAY-DATE	EXPLORER	GMT-MASTER	MILGAUSS
OYSTER PERPETUAL	SEA-DWELLER	SKY-DWELLER	SUBMARINER	YACHT-MASTER	CELLINI	ORCHID

DATEJUST

 Acero / Oro / Diamantes

 31 mm

 Automático

PRECIO 
\$15,500

 OBARRIO  CAJA  PAPELES

REF. 278274



LADY-DATEJUST

 Acero

 26 mm

 Automático

PRECIO 
\$6,500

 OBARRIO

REF. 69174

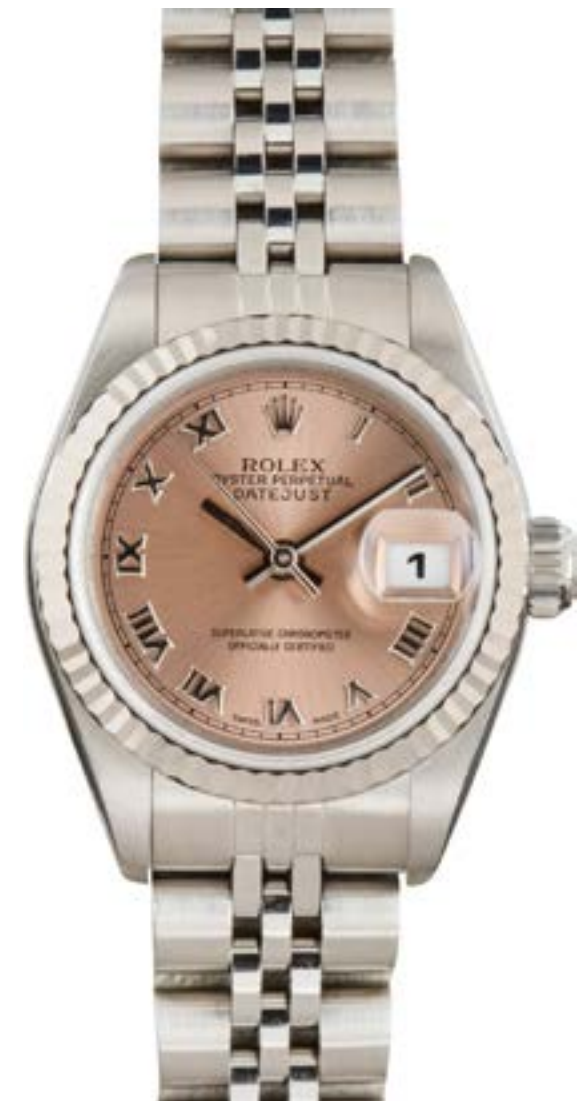

DATEJUST

 Acero / Oro

 26 mm

 Automático

PRECIO 
\$5,500

 OBARRIO

REF. 69173



DATEJUST

 Acero / Oro

 36 mm

 Automático

PRECIO 
\$6,500

 OBARRIO

REF. 16233



DATEJUST

 Acero / Oro

 36 mm

 Automático

PRECIO 
\$5,500

 OBARRIO  PAPELES

REF. 15053



DATEJUST

 Acero

 36 mm

 Automático

PRECIO 
\$5,000

 OBARRIO  CAJA  PAPELES

REF. 1603



AIR KING	DAYTONA	DATEJUST	DAY-DATE	EXPLORER	GMT-MASTER	MILGAUSS
OYSTER PERPETUAL	SEA-DWELLER	SKY-DWELLER	SUBMARINER	YACHT-MASTER	CELLINI	ORCHID



CAJA



DAY-DATE



OBARRIO

-  Oro
-  41 mm
-  Automático

PRECIO 
\$39,800



REF. 218239

AIR KING	DAYTONA	DATEJUST	DAY-DATE	EXPLORER	GMT-MASTER	MILGAUSS
OYSTER PERPETUAL	SEA-DWELLER	SKY-DWELLER	SUBMARINER	YACHT-MASTER	CELLINI	ORCHID

DAY-DATE

- Oro Amarillo 18 k
- 36 mm
- Automático

PRECIO \$23,000



REF. 18038

DAY-DATE

"CONFETI DIAL"

- Oro Amarillo
- 36 mm
- Automático

PRECIO \$24,000



REF. 1803

DAY-DATE

"Aftermarket-set diamonds"

- Oro Amarillo
- 40 mm
- Automático

PRECIO \$58,000



REF. 228238

DAY-DATE

"FACTORY DIAMOND DIAL"
"BISEL AFTERMARKET"

- Oro Rosa 18 k
- 41 mm
- Automático

PRECIO \$50,000



REF. 218235

DAY-DATE

- Oro Amarillo 18 k
- 36 mm
- Automático

PRECIO \$23,000



REF. 18238

DAY-DATE

- Oro Amarillo 18 k
- 36 mm
- Automático

PRECIO \$20,500





REF. 18238

AIR KING	DAYTONA	DATEJUST	DAY-DATE	EXPLORER	GMT-MASTER	MILGAUSS
OYSTER PERPETUAL	SEA-DWELLER	SKY-DWELLER	SUBMARINER	YACHT-MASTER	CELLINI	ORCHID

DAY-DATE



-  Oro
-  36 mm
-  Automático

PRECIO 
\$16,800





REF. 1803

DAY-DATE

"BISEL CON DIAMANTES"



-  Oro
-  36 mm
-  Automático

PRECIO 
\$22,000



REF. 18048

DAY-DATE



-  Oro / Diamantes
-  36 mm
-  Automático

PRECIO 
\$19,400



REF. 18038

DAY-DATE

"DIAL DE DIAMANTES"



-  Oro / Diamantes
-  36 mm
-  Automático



PRECIO 
\$21,050



REF. 18238

DAY-DATE



-  Oro Blanco
-  36 mm
-  Automático



PRECIO 
\$22,000



REF. 18239

DAY-DATE



-  Oro
-  36 mm
-  Automático

PRECIO 
\$17,800





REF. 1803

AIR KING	DAYTONA	DATEJUST	DAY-DATE	EXPLORER	GMT-MASTER	MILGAUSS
OYSTER PERPETUAL	SEA-DWELLER	SKY-DWELLER	SUBMARINER	YACHT-MASTER	CELLINI	ORCHID

DAY-DATE



REF. 1803

-  Oro
-  36 mm
-  Automático

PRECIO 
\$9,000





OBARRIO

DAY-DATE

"BISEL CON DIAMANTES"



REF. 1803

-  Oro
-  36 mm
-  Automático

PRECIO 
\$15,000



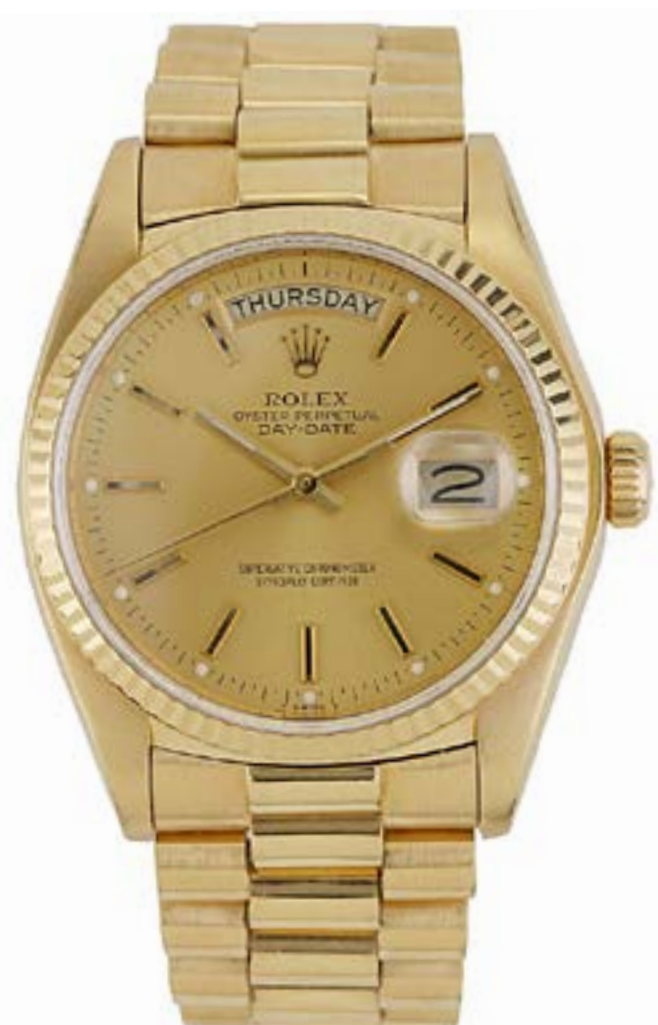

OBARRIO

DAY-DATE



REF. 1803

-  Oro
-  36 mm
-  Automático

PRECIO 
\$16,600





OBARRIO

DAY-DATE



REF. 118209

-  Oro Blanco
-  36 mm
-  Automático

PRECIO 
\$25,500



OBARRIO



CAJA





PAPELES

DAY-DATE



REF. 128238

-  Oro
-  36 mm
-  Automático

PRECIO 
\$46,000



OBARRIO



CAJA





PAPELES

DAY-DATE

"COSTUM BEZEL & DIAL"



REF. 1803

-  Oro Amarillo
-  36 mm
-  Automático

PRECIO 
\$15,000





OBARRIO

AIR KING	DAYTONA	DATEJUST	DAY-DATE	EXPLORER	GMT-MASTER	MILGAUSS
OYSTER PERPETUAL	SEA-DWELLER	SKY-DWELLER	SUBMARINER	YACHT-MASTER	CELLINI	ORCHID

DAY-DATE



-  Oro Amarillo
-  40 mm
-  Automático



PRECIO 
\$48,000

-  OBARRIO
-  CAJA
-  PAPELES

REF. 228238

DAY-DATE



-  Oro Rosa
-  40 mm
-  Automático

PRECIO 
\$48,000



-  OBARRIO

REF. 228235

DAY-DATE

DIAL LAPISLAZULI Y DIAMANTES AFTERMARKET



-  Oro Amarillo
-  36 mm
-  Automático



PRECIO 
\$25,000

-  OBARRIO

REF. 18238

DAY-DATE



-  Oro Amarillo
-  36 mm
-  Automático

PRECIO 
\$20,000

-  OBARRIO

REF. 18038

ROLEX
ROLEX





EXPLORER

El Explorer es un modelo emblemático de Rolex, inspirado en el espíritu de la exploración y la aventura. Presentado en 1953 tras la histórica ascensión al Monte Everest, fue diseñado para ofrecer máxima legibilidad, resistencia y precisión en condiciones extremas.

Su estética sobria, con los característicos números 3, 6 y 9 en la esfera, refleja funcionalidad pura. Robusto y confiable, el Explorer encarna la esencia del reloj herramienta llevado a su expresión más elegante y atemporal.

AIR KING	DAYTONA	DATEJUST	DAY-DATE	EXPLORER	GMT-MASTER	MILGAUSS
OYSTER PERPETUAL	SEA-DWELLER	SKY-DWELLER	SUBMARINER	YACHT-MASTER	CELLINI	ORCHID

EXPLORER II

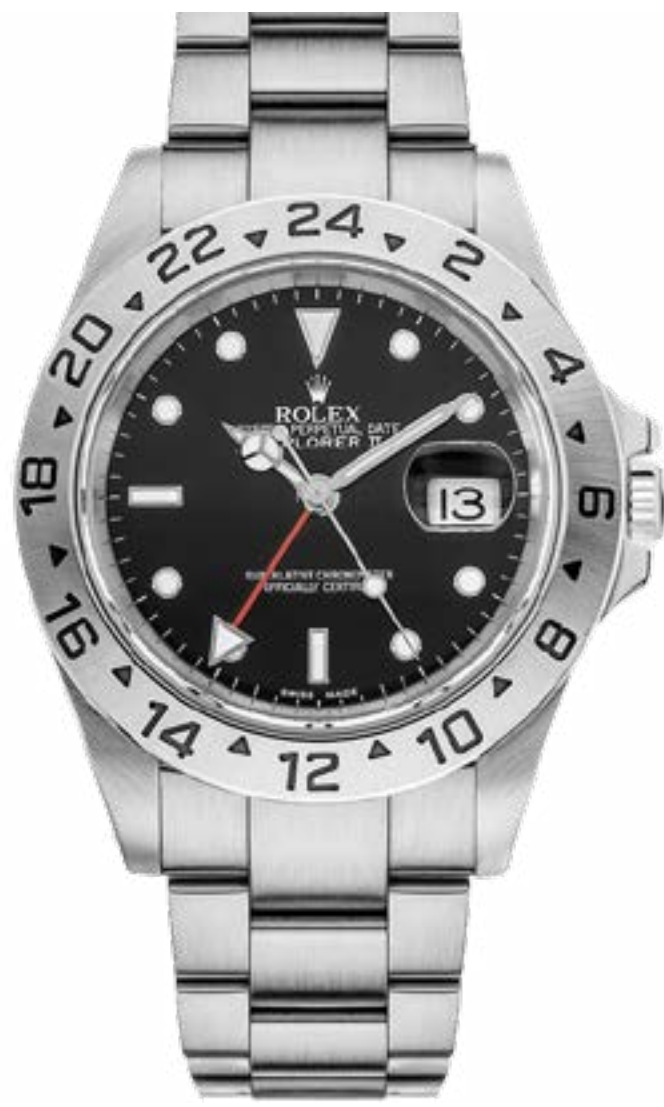

-  Acero
-  40 mm
-  Automático

PRECIO 
\$8,000



REF. 16570

EXPLORER II

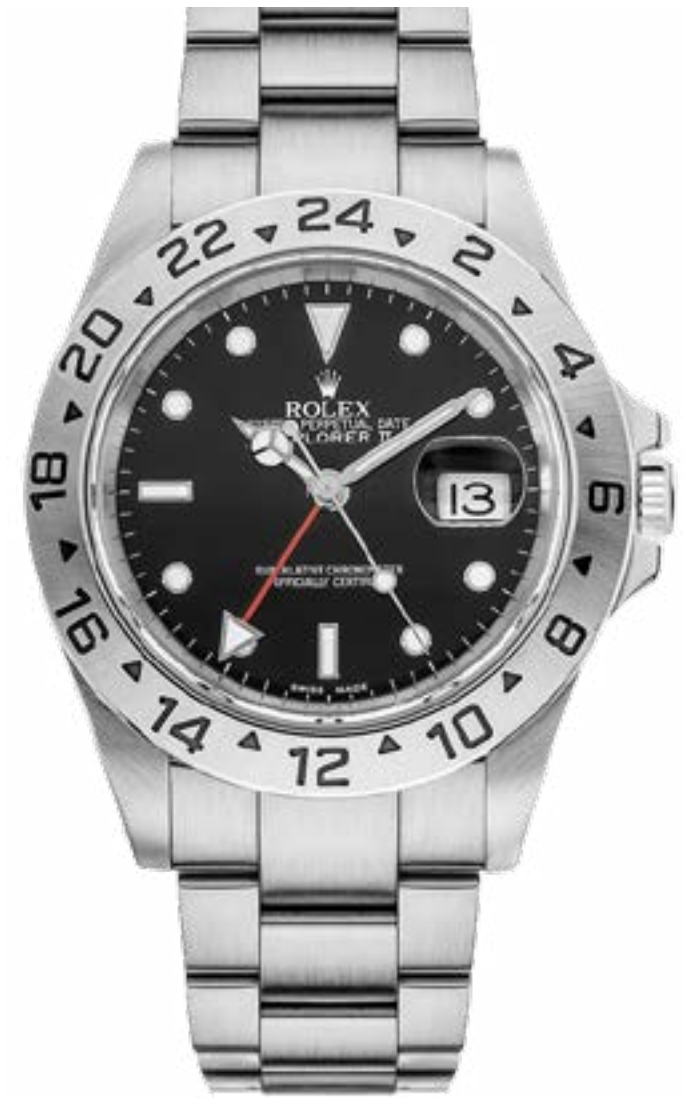

-  Acero
-  40 mm
-  Automático

PRECIO 
\$8,000



REF. 16570

EXPLORER II



-  Acero
-  40 mm
-  Automático

PRECIO 
\$10,000



REF. 16570

EXPLORER II

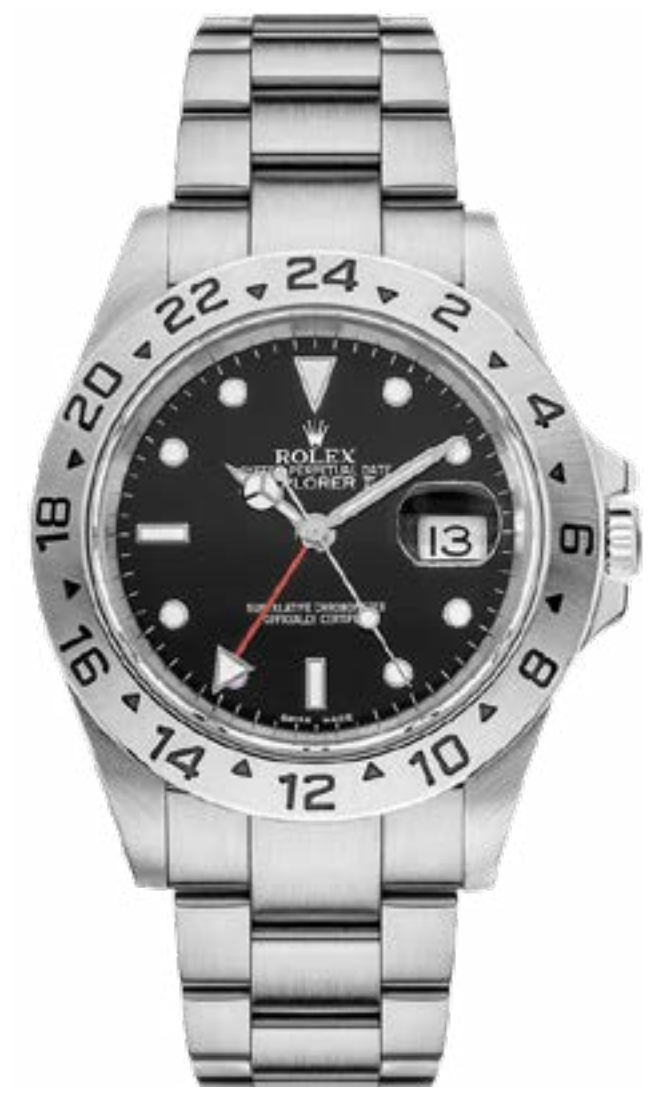

-  Acero
-  40 mm
-  Automático

PRECIO 
\$8,000



REF. 16570

EXPLORER II

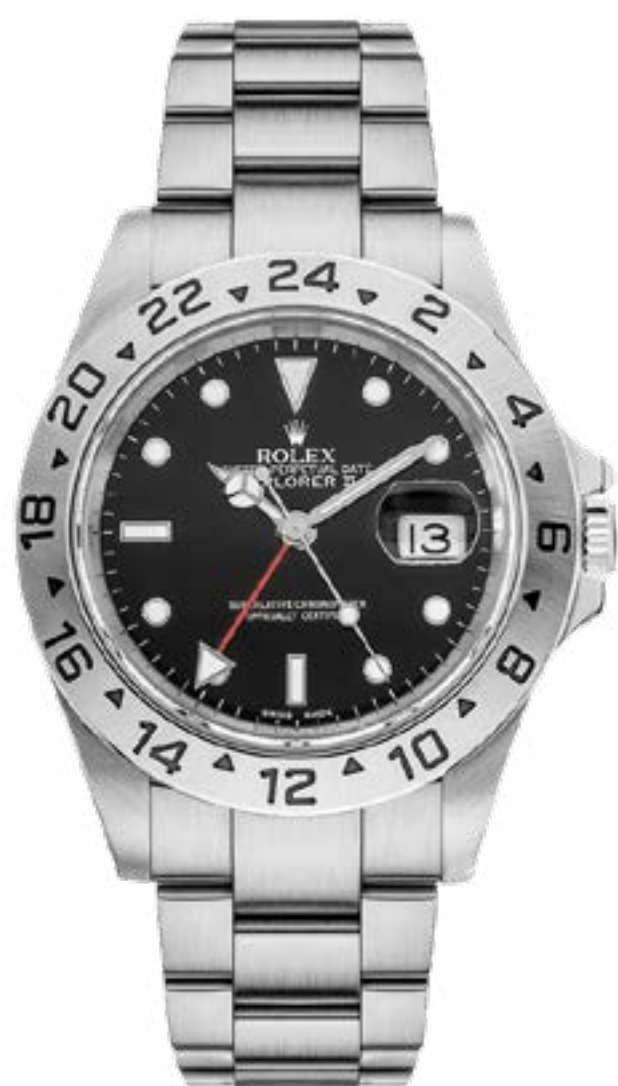

-  Acero
-  40 mm
-  Automático

PRECIO 
\$9,500



REF. 16570

EXPLORER II

-  Acero
-  40 mm
-  Automático

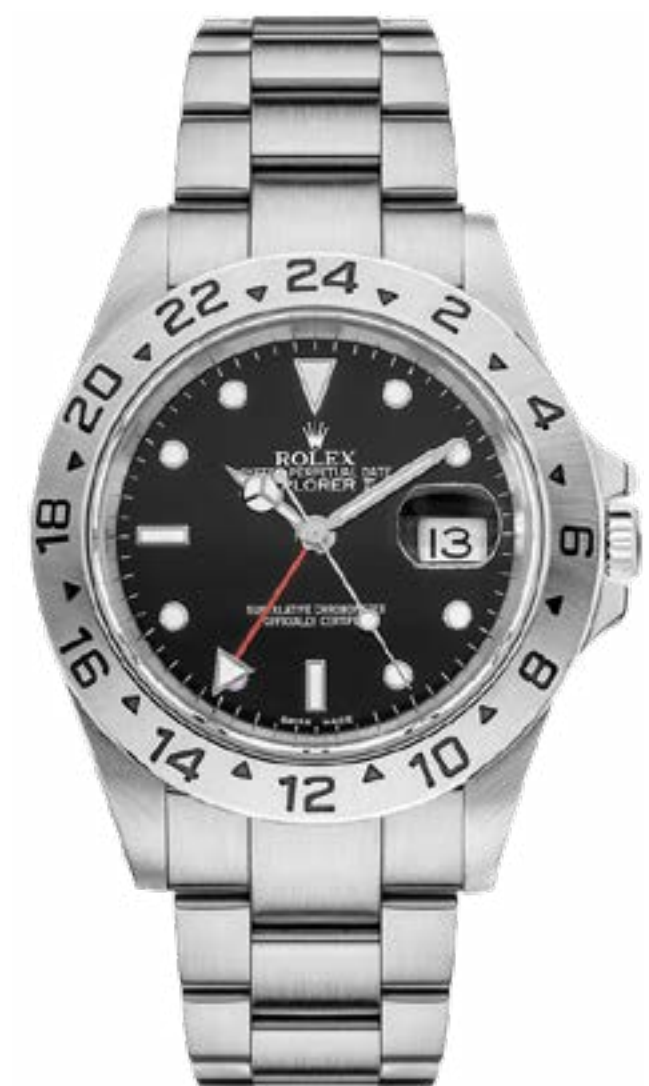

PRECIO 
\$8,000



REF. 16570

AIR KING	DAYTONA	DATEJUST	DAY-DATE	EXPLORER	GMT-MASTER	MILGAUSS
OYSTER PERPETUAL	SEA-DWELLER	SKY-DWELLER	SUBMARINER	YACHT-MASTER	CELLINI	ORCHID

EXPLORER II

-  Acero
-  42 mm
-  Automático



PRECIO 
\$11,800

-  OBARRIO
-  CAJA
-  PAPELES



REF. 216570

EXPLORER II

-  Acero
-  42 mm
-  Automático



PRECIO 
\$11,800

-  OBARRIO
-  CAJA
-  PAPELES



REF. 216570

EXPLORER II

-  Acero
-  42 mm
-  Automático



PRECIO 
\$10,500

-  OBARRIO
-  CAJA
-  PAPELES



REF. 216570

EXPLORER II

-  Acero
-  42 mm
-  Automático



PRECIO 
\$11,000

-  OBARRIO



REF. 216570

EXPLORER II

-  Acero
-  42 mm
-  Automático

PRECIO 
\$11,000

-  OBARRIO



REF. 216570

AIR KING	DAYTONA	DATEJUST	DAY-DATE	EXPLORER	GMT-MASTER	MILGAUSS
OYSTER PERPETUAL	SEA-DWELLER	SKY-DWELLER	SUBMARINER	YACHT-MASTER	CELLINI	ORCHID

EXPLORER II

- Acero
- 40 mm
- Automático

PRECIO 
\$8,500



OBARRIO



REF. 16570

EXPLORER II

- Acero
- 40 mm
- Automático

PRECIO 
\$8,500



OBARRIO



REF. 16570

EXPLORER II

- Acero
- 40 mm
- Automático

PRECIO 
\$14,000



OBARRIO

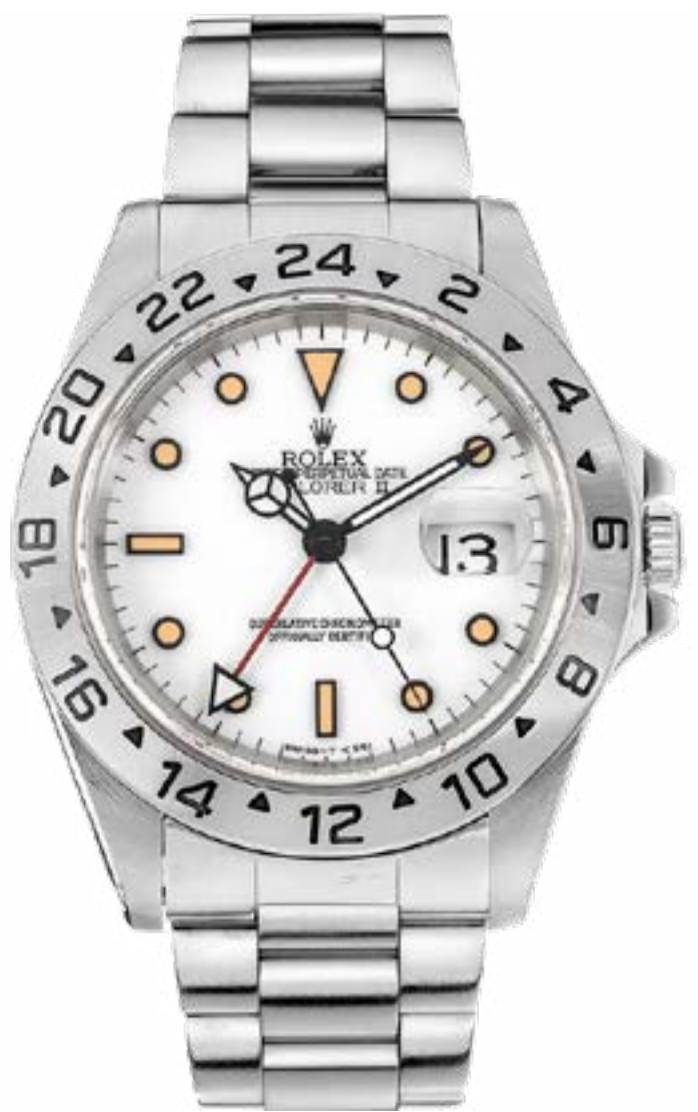

REF. 16570

EXPLORER II

- Acero
- 40 mm
- Automático

PRECIO 
\$10,000



OBARRIO



REF. 16570



ROLEX

GMT-MASTER II

- Zombie -

 Oro

 40 mm

 Automático

PRECIO 
\$50,000

OBARRIO

CAJA

PAPELES



REF. 126718GRNR

AARON  JOYEROS





ROLEX



GMT-MASTER II

PEPSI



-  Acero
-  40 mm
-  Automático



OBARRIO

PRECIO 
\$13,000

REF. 16700

AARON  JOYEROS

AIR KING	DAYTONA	DATEJUST	DAY-DATE	EXPLORER	GMT-MASTER	MILGAUSS
OYSTER PERPETUAL	SEA-DWELLER	SKY-DWELLER	SUBMARINER	YACHT-MASTER	CELLINI	ORCHID

BATMAN — GMT-MASTER II



- Acero
- 40 mm
- Automático

PRECIO \$16,800

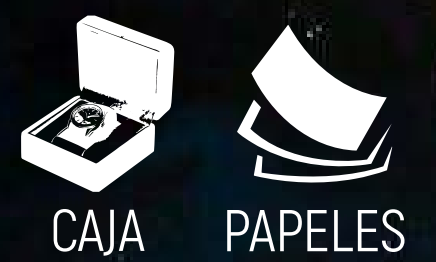

REF. 116710BLNR



OBARRIO



AIR KING	DAYTONA	DATEJUST	DAY-DATE	EXPLORER	GMT-MASTER	MILGAUSS
OYSTER PERPETUAL	SEA-DWELLER	SKY-DWELLER	SUBMARINER	YACHT-MASTER	CELLINI	ORCHID

GMT-MASTER II

ROOT BEER



REF. 16753

-  Acero / Oro
-  40 mm
-  Automático

PRECIO 
\$14,800

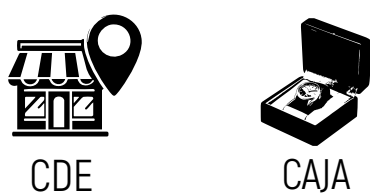



GMT-MASTER

ROOT BEER



REF. 1675

-  Oro
-  40 mm
-  Automático

PRECIO 
\$50,000



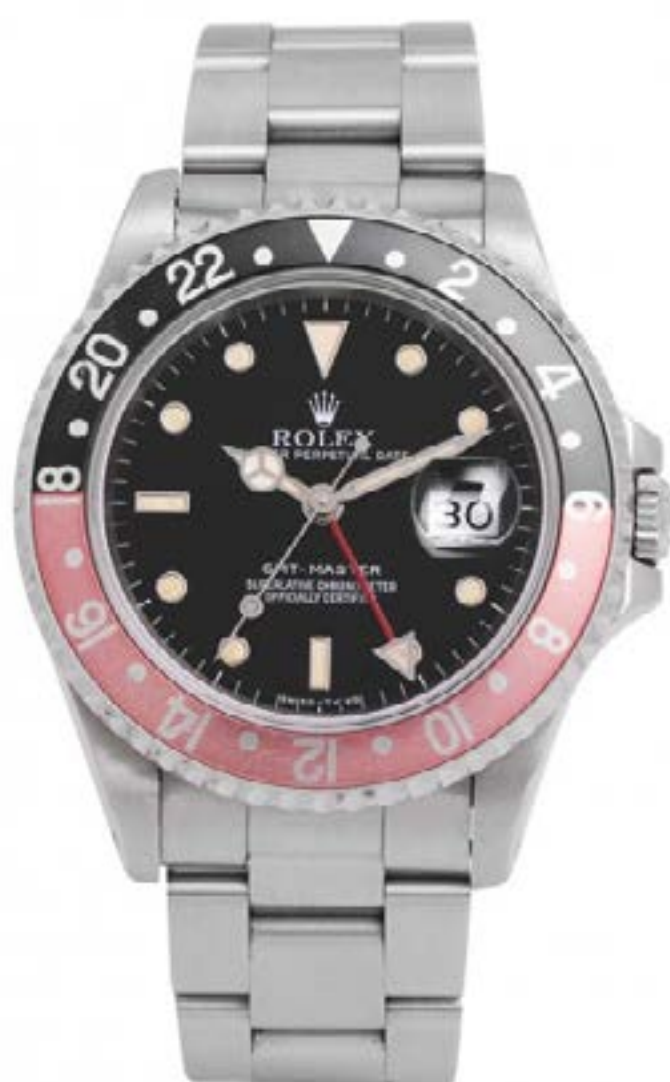

GMT-MASTER II

"SPYDER DIAL"



REF. 16700

-  Acero
-  40 mm
-  Automático

PRECIO 
\$10,800



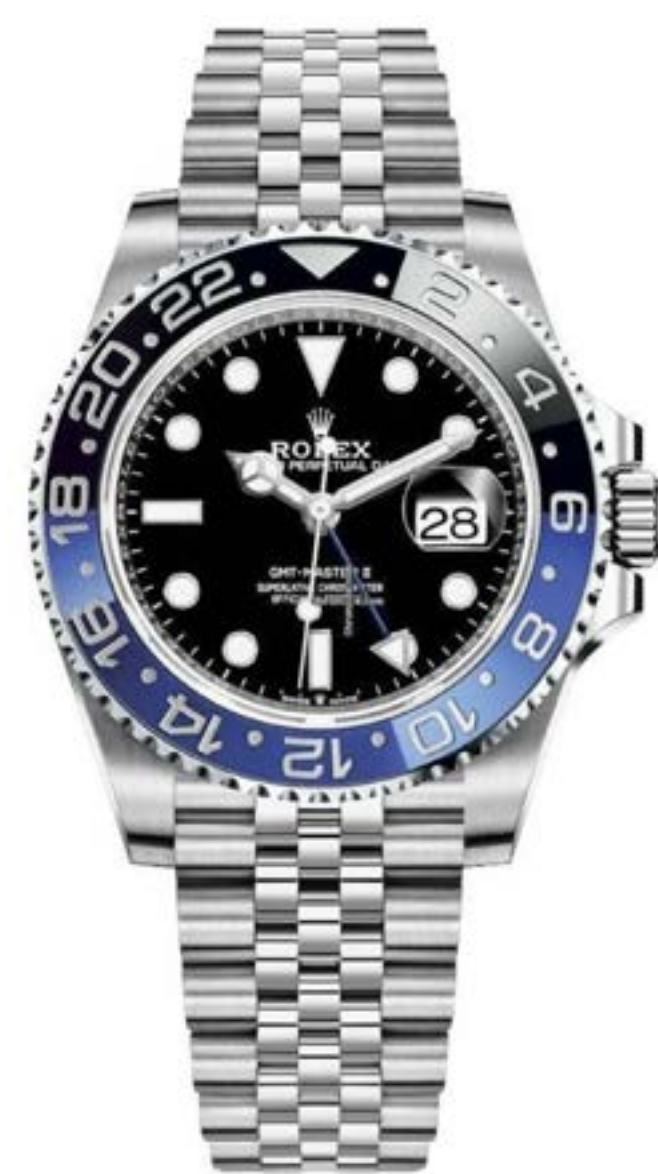

GMT-MASTER II

BATGIRL



REF. 126710BLN

-  Acero
-  40 mm
-  Automático

PRECIO 
\$19,000





GMT-MASTER II

PEPSI



REF. 16710

-  Acero
-  40 mm
-  Automático

PRECIO 
\$15,000





GMT-MASTER II

BATMAN



REF. 126710BLNR

-  Acero
-  40 mm
-  Automático

PRECIO 
\$19,000



AIR KING	DAYTONA	DATEJUST	DAY-DATE	EXPLORER	GMT-MASTER	MILGAUSS
OYSTER PERPETUAL	SEA-DWELLER	SKY-DWELLER	SUBMARINER	YACHT-MASTER	CELLINI	ORCHID

GMT-MASTER

"NIPLE DIAL"

 Acero / Oro

 40 mm

 Automático

PRECIO 
\$10,000



CDE



REF. 16753

GMT-MASTER

 Acero / Oro

 40 mm

 Automático

PRECIO 
\$11,500



OBARRIO

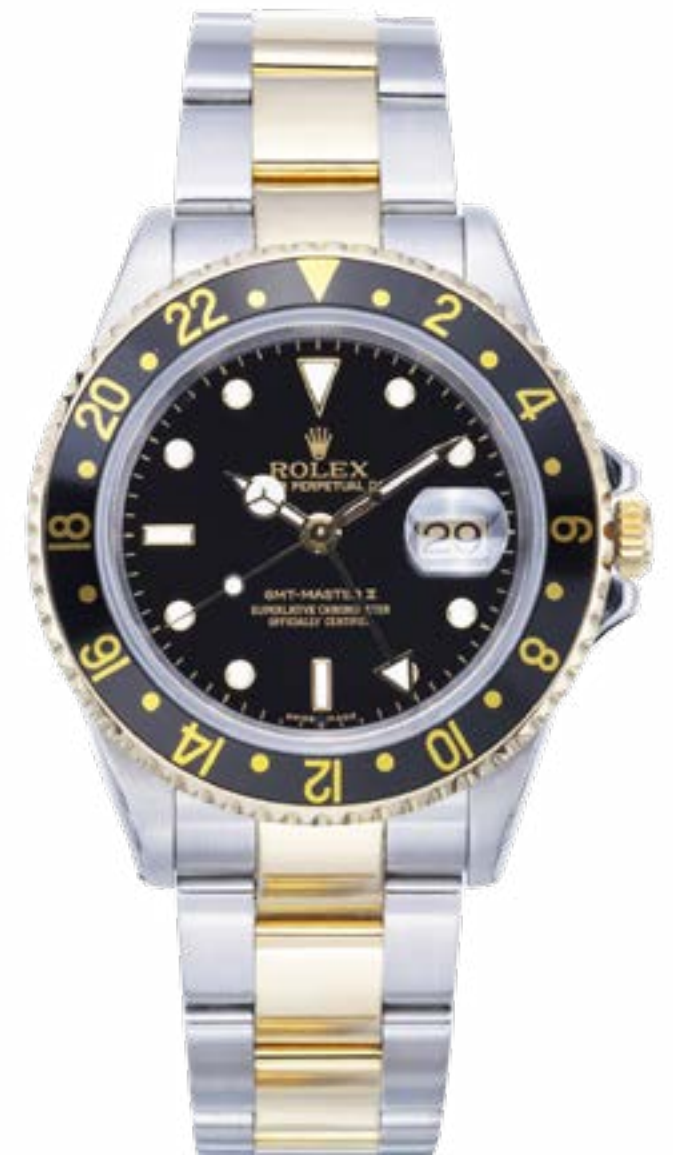

REF. 16713

GMT-MASTER

 Acero / Oro

 40 mm

 Automático

PRECIO 
\$10,500



OBARRIO



REF. 1675

GMT-MASTER

"NIPLE DIAL"

 Acero / Oro

 40 mm

 Automático

PRECIO 
\$9,000



OBARRIO



REF. 1675

GMT-MASTER

 Acero / Oro

 40 mm

 Automático

PRECIO 
\$10,800





OBARRIO



REF. 16753

AIR KING	DAYTONA	DATEJUST	DAY-DATE	EXPLORER	GMT-MASTER	MILGAUSS
OYSTER PERPETUAL	SEA-DWELLER	SKY-DWELLER	SUBMARINER	YACHT-MASTER	CELLINI	ORCHID

GMT-MASTER II

-  Acero
-  40 mm
-  Automático

PRECIO 
\$13,000





CDE



REF. 116710LN

GMT-MASTER II

-  Acero
-  40 mm
-  Automático

PRECIO 
\$13,000



OBARRIO





CAJA



REF. 116710LN

GMT-MASTER II

-  Acero
-  40 mm
-  Automático

PRECIO 
\$13,000



CDE





CAJA



REF. 116710

GMT-MASTER II

-  Acero
-  40 mm
-  Automático

PRECIO 
\$14,000



CDE



CAJA



PAPELES

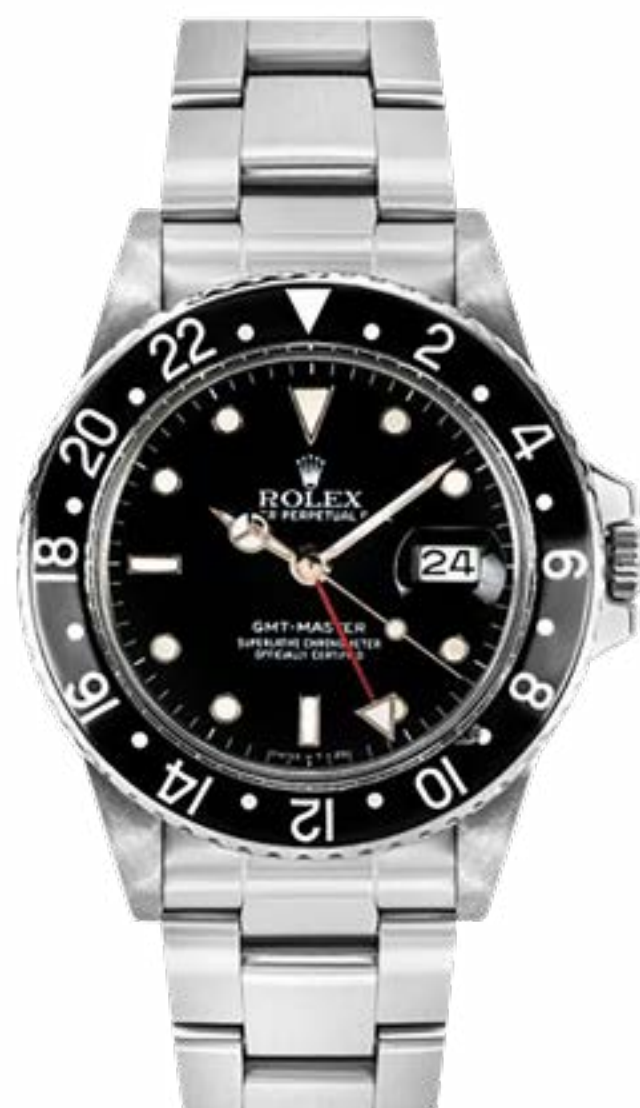

REF. 16750



OYSTER PERPETUAL MILGAUSS



- Acero
- 40 mm
- Automático

PRECIO \$9,800

REF. 116400



ROLEX

OYSTER PERPETUAL
MILGAUSS



OBARRIO

REF. 116400

REF.

MILGAUSS

 Acero

 40 mm

 Automático

PRECIO 
\$9,800

AARON  JOYEROS



ROLEX



OYSTER PERPETUAL



Acero



39 mm



Automático

PRECIO



\$8,500



114300

REF.





OBARRIO



ROLEX

OYSTER PERPETUAL

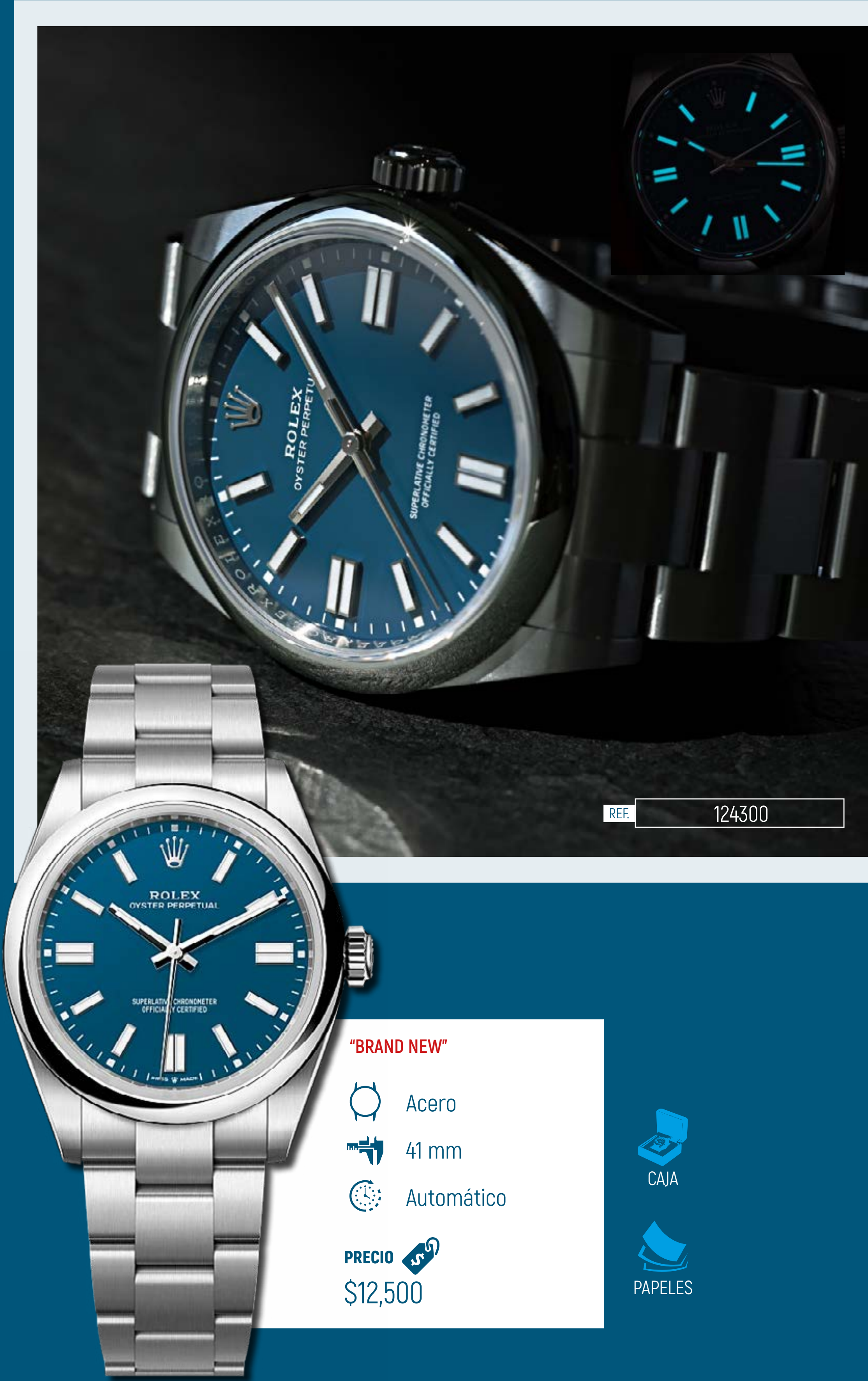

REF. 124300

"BRAND NEW"

 Acero

 41 mm

 Automático

PRECIO 
\$12,500



CAJA



PAPELES

AIR KING	DAYTONA	DATEJUST	DAY-DATE	EXPLORER	GMT-MASTER	MILGAUSS
OYSTER PERPETUAL	SEA-DWELLER	SKY-DWELLER	SUBMARINER	YACHT-MASTER	CELLINI	ORCHID

OYSTER PERPETUAL

"TIFFANY DIAL"

- Acero
- 31 mm
- Automático

PRECIO \$12,500

- OBARRIO
- CAJA
- PAPELES



REF. 277200

OYSTER PERPETUAL
CORAL ROJO

- Acero
- 31 mm
- Automático

PRECIO \$11,000

- OBARRIO
- PAPELES



REF. 277200

OYSTER PERPETUAL

- Oro Amariillo
- 26 mm
- Cuerda Manual

PRECIO \$8,600

- CDE



REF. 6619

OYSTER PERPETUAL

- Oro
- 34 mm
- Automático

PRECIO \$11,500

- OBARRIO



REF. 100S

OYSTER PERPETUAL

- Oro Amarillo
- 24 mm
- Automático

PRECIO \$9,500

- OBARRIO
- CAJA





REF. 6617

AIR KING	DAYTONA	DATEJUST	DAY-DATE	EXPLORER	GMT-MASTER	MILGAUSS
OYSTER PERPETUAL	SEA-DWELLER	SKY-DWELLER	SUBMARINER	YACHT-MASTER	CELLINI	ORCHID

OYSTER PERPETUAL

"DÓMINOS PIZZA"

"NUEVO A ESTRENAR"

-  Acero
-  36 mm
-  Automático

PRECIO 
\$9,000

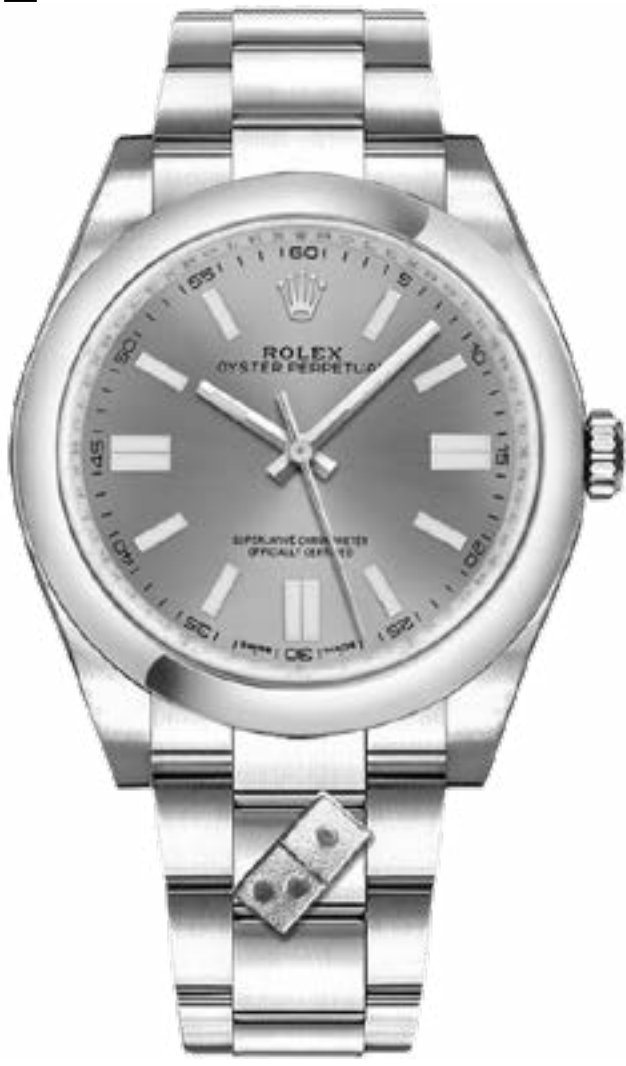

-  OBARRIO
-  CAJA
-  PAPELES



REF. 116000



OYSTER PERPETUAL

-  Acero
-  24 mm
-  Automático

PRECIO  \$2,500

-  OBARRIO

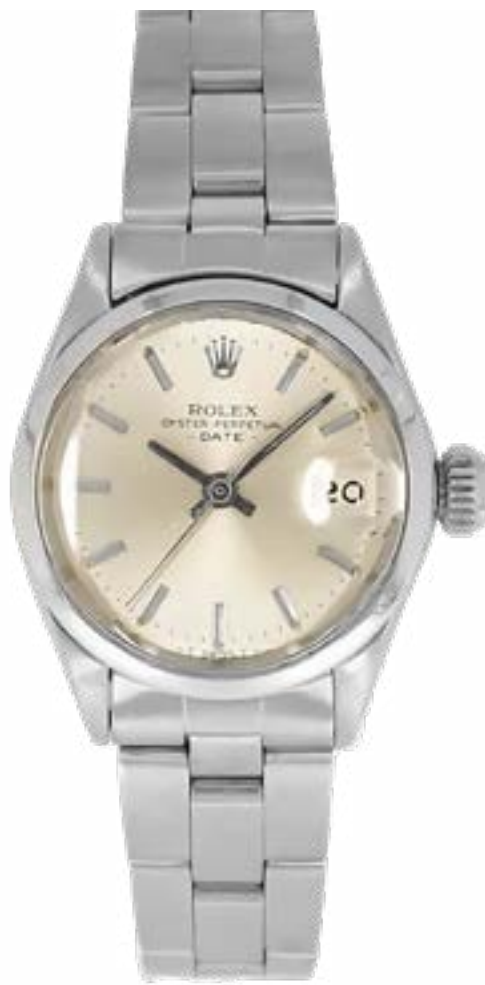



REF. 6516



OYSTER PERPETUAL

DATE

-  Acero
-  26 mm
-  Automático

PRECIO  \$3,000

-  OBARRIO



REF. 6916



ROLEX

SEASIDE



Acero



40 mm



Automático

PRECIO



\$9,250



16600

REF.

ROLEX

SKY-DWELLER



-  Oro Rosa
-  42 mm
-  Automático

PRECIO 
\$44,000

OBARRIO

PAPELES

REF. 326235



REF.

AIR KING	DAYTONA	DATEJUST	DAY-DATE	EXPLORER	GMT-MASTER	MILGAUSS
OYSTER PERPETUAL	SEA-DWELLER	SKY-DWELLER	SUBMARINER	YACHT-MASTER	CELLINI	ORCHID



SKY-DWELLER



-  Acero / Oro
-  42 mm
-  Automático

PRECIO 
\$22,500



REF 326933



SKY-DWELLER

El Rolex Sky-Dweller es uno de los modelos más sofisticados de Rolex, creado para viajeros frecuentes que requieren funcionalidad y elegancia en una sola pieza. Combina un calendario anual que distingue automáticamente los meses de 30 y 31 días con un segundo huso horario visible mediante un disco excéntrico en la esfera.



ROLEX



 Oro Rosa 18 k

 42 mm

 Automático

PRECIO 
\$45,000

CDE

CAJA

REF. 326935

AARON  JOYEROS



ROLEX

SUBMARINER

El Rolex Submariner, lanzado en 1953 por Rolex, es uno de los relojes de buceo más icónicos del mundo. Diseñado para ofrecer máxima resistencia y precisión bajo el agua, combina funcionalidad profesional con una estética elegante y atemporal, convirtiéndose en un símbolo de lujo deportivo y referencia en la alta relojería.





ROLEX

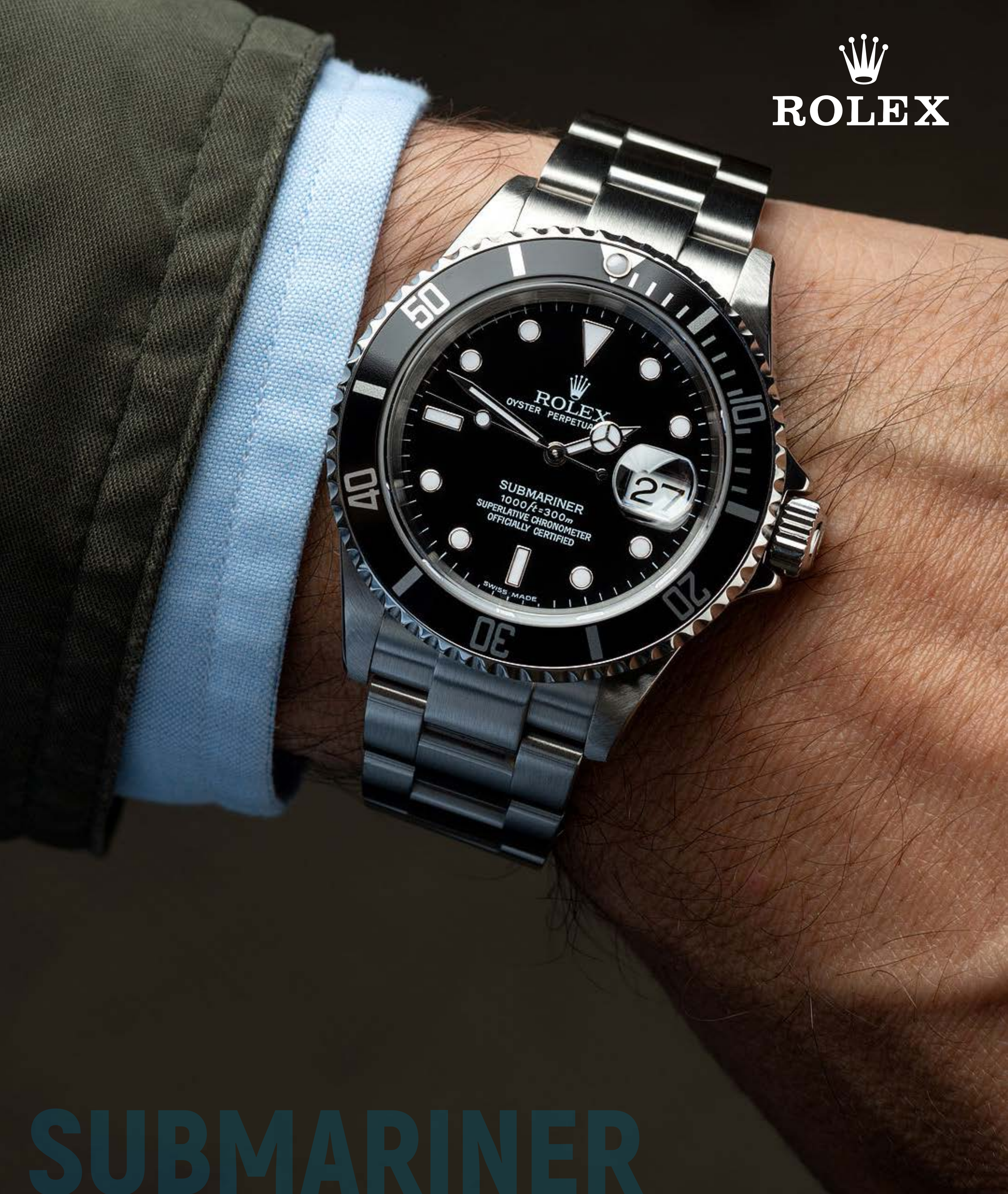

SUBMARINER



Acero



40 mm



Automático

PRECIO 
\$10,000



OBARRIO



16610

REF.

AARON  JOYEROS

AIR KING	DAYTONA	DATEJUST	DAY-DATE	EXPLORER	GMT-MASTER	MILGAUSS
OYSTER PERPETUAL	SEA-DWELLER	SKY-DWELLER	SUBMARINER	YACHT-MASTER	CELLINI	ORCHID

SUBMARINER DATE

-  Acero
-  40 mm
-  Automático

PRECIO 
\$9,600





OBARRIO



REF. 16610

SUBMARINER DATE

-  Acero
-  40 mm
-  Automático

PRECIO 
\$9,700



OBARRIO





CAJA



REF. 16610

SUBMARINER DATE

-  Acero
-  40 mm
-  Automático

PRECIO 
\$10,000





OBARRIO



REF. 16610

SUBMARINER DATE

-  Acero
-  40 mm
-  Automático

PRECIO 
\$10,000





OBARRIO



REF. 16610

SUBMARINER DATE

-  Acero
-  40 mm
-  Automático

PRECIO 
\$12,000





CDE



REF. 16610

SUBMARINER DATE

-  Acero
-  40 mm
-  Automático

PRECIO 
\$10,000



OBARRIO



CAJA



PAPELES



REF. 16610

AIR KING	DAYTONA	DATEJUST	DAY-DATE	EXPLORER	GMT-MASTER	MILGAUSS
OYSTER PERPETUAL	SEA-DWELLER	SKY-DWELLER	SUBMARINER	YACHT-MASTER	CELLINI	ORCHID

SUBMARINER
DATE

- Acero
- 40 mm
- Automático

PRECIO 
\$10,500

-  OBARRIO
-  CAJA
-  PAPELES



REF. 16610

SUBMARINER
NO DATE

- Acero
- 40 mm
- Automático

PRECIO 
\$13,000

-  OBARRIO



REF. 5512

SUBMARINER
DATE

- Acero
- 40 mm
- Automático

PRECIO 
\$12,800

-  OBARRIO



REF. 1680

SUBMARINER
NO DATE

- Acero
- 40 mm
- Automático

PRECIO 
\$16,000

-  OBARRIO



REF. 5513

SUBMARINER
DATE

- Acero
- 40 mm
- Automático

PRECIO 
\$16,500

-  OBARRIO



REF. 1680

SUBMARINER
NO DATE

- Acero
- 40 mm
- Automático

PRECIO 
\$8,500

-  OBARRIO



REF. 14060

AIR KING	DAYTONA	DATEJUST	DAY-DATE	EXPLORER	GMT-MASTER	MILGAUSS
OYSTER PERPETUAL	SEA-DWELLER	SKY-DWELLER	SUBMARINER	YACHT-MASTER	CELLINI	ORCHID

SUBMARINER
NO DATE

- Acero
- 40 mm
- Automático

PRECIO 
\$10,000



OBARRIO

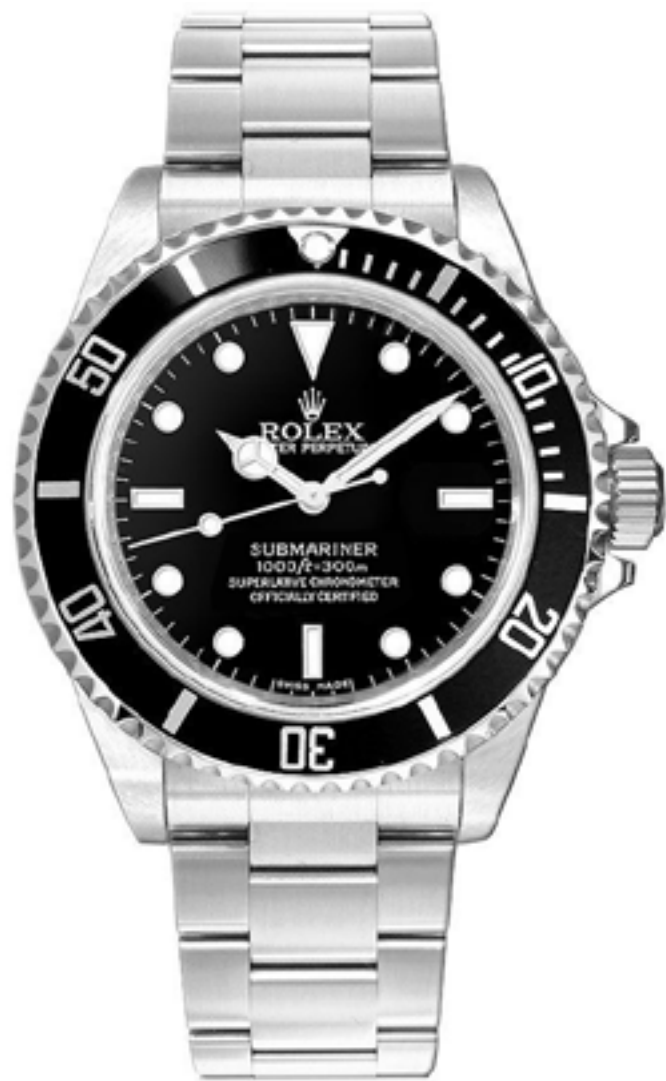

REF. 14060M

SUBMARINER
NO DATE

- Acero
- 40 mm
- Automático

PRECIO 
\$11,500



OBARRIO



REF. 114060

SUBMARINER
DATE

- Acero
- 40 mm
- Automático

PRECIO 
\$13,800



OBARRIO



CAJA



PAPELES



REF. 116610

SUBMARINER
DATE

- Acero
- 40 mm
- Automático

PRECIO 
\$13,500



OBARRIO



CAJA



PAPELES



REF. 116610



AIR KING	DAYTONA	DATEJUST	DAY-DATE	EXPLORER	GMT-MASTER	MILGAUSS
OYSTER PERPETUAL	SEA-DWELLER	SKY-DWELLER	SUBMARINER	YACHT-MASTER	CELLINI	ORCHID

SUBMARINER
DATE

- Acero
- 40 mm
- Automático

PRECIO 
\$13,800

-  OBARRIO
-  CAJA
-  PAPELES



REF. 116610

SUBMARINER
NO DATE

- Acero
- 40 mm
- Automático

PRECIO 
\$10,000

-  CDE



REF. 5513

SUBMARINER
DATE

- Acero
- 40 mm
- Automático

PRECIO 
\$12,800

-  OBARRIO
-  CAJA



REF. 116610

SUBMARINER
NO DATE

- Acero
- 40 mm
- Automático

PRECIO 
\$15,000

-  CDE

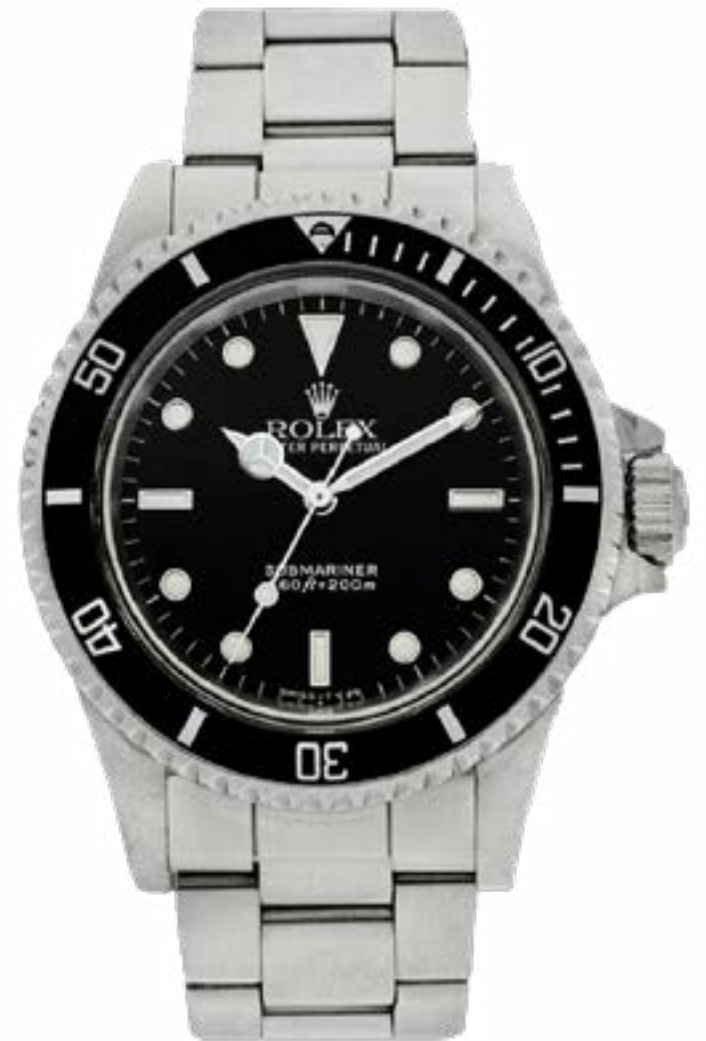

REF. 5513

SUBMARINER
DATE

- Acero
- 40 mm
- Automático

PRECIO 
\$13,000

-  OBARRIO



REF. 116610

SUBMARINER
DATE

- Acero
- 40 mm
- Automático

PRECIO 
\$13,500

-  OBARRIO
-  CAJA
-  PAPELES



REF. 116610

AIR KING	DAYTONA	DATEJUST	DAY-DATE	EXPLORER	GMT-MASTER	MILGAUSS
OYSTER PERPETUAL	SEA-DWELLER	SKY-DWELLER	SUBMARINER	YACHT-MASTER	CELLINI	ORCHID

SUBMARINER
DATE

- Acero
- 40 mm
- Automático

PRECIO 
\$9.800



OBARRIO



REF. 16610



SUBMARINER
DATE

- Acero
- 40 mm
- Automático

PRECIO 
\$10,000



OBARRIO



CAJA



REF. 16610



SUBMARINER

- Acero
- 40 mm
- Automático

PRECIO 
\$10,800



CDE



CAJA



PAPELES



REF. 16610

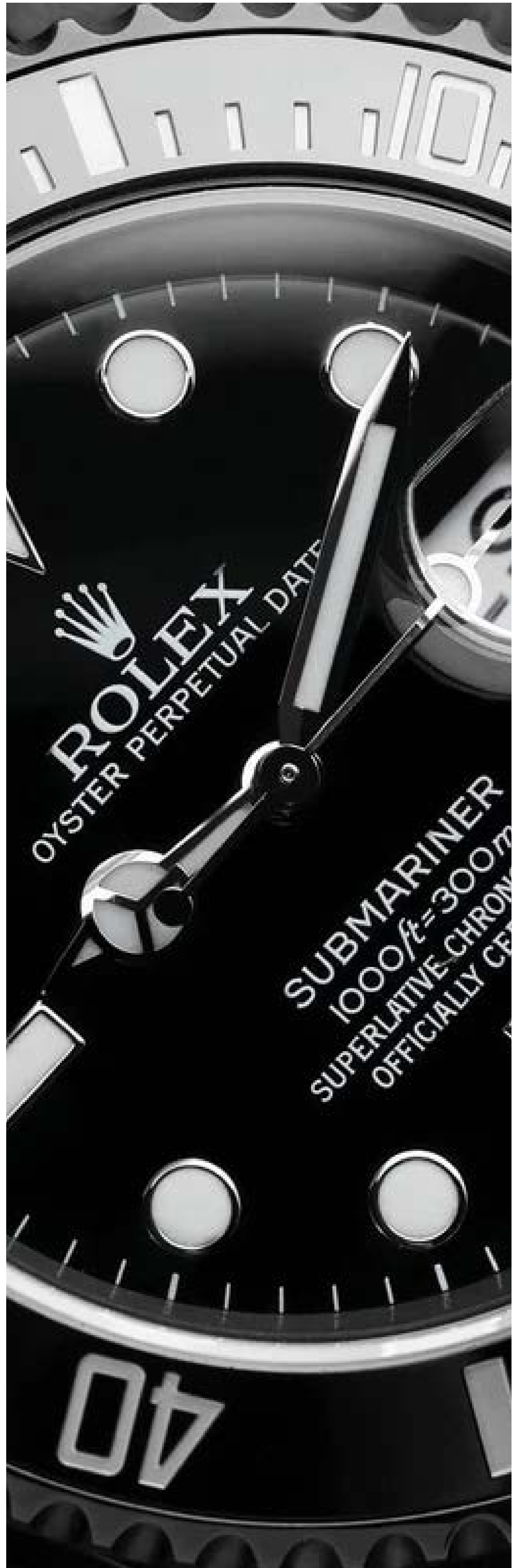

AIR KING	DAYTONA	DATEJUST	DAY-DATE	EXPLORER	GMT-MASTER	MILGAUSS
OYSTER PERPETUAL	SEA-DWELLER	SKY-DWELLER	SUBMARINER	YACHT-MASTER	CELLINI	ORCHID

SUBMARINER

- Acero / Oro
- 40 mm
- Automático

PRECIO 
\$12,500



REF. 16613

SUBMARINER

- Acero / Oro
- 40 mm
- Automático

PRECIO 
\$13,000



REF. 16613



SUBMARINER

- Acero / Oro
- 40 mm
- Automático

PRECIO 
\$15,500



REF. 116613

SUBMARINER

- Acero / Oro
- 40 mm
- Automático

PRECIO 
\$13,000



REF. 16613



SUBMARINER

- Acero / Oro
- 40 mm
- Automático

PRECIO 
\$12,500



REF. 16613

SUBMARINER

- Acero / Oro
- 40 mm
- Automático

PRECIO 
\$11,000



REF. 16803

AIR KING	DAYTONA	DATEJUST	DAY-DATE	EXPLORER	GMT-MASTER	MILGAUSS
OYSTER PERPETUAL	SEA-DWELLER	SKY-DWELLER	SUBMARINER	YACHT-MASTER	CELLINI	ORCHID

SUBMARINER

Acero / Oro

40 mm

Automático

PRECIO
\$13,000



CDE



REF. 16613

SUBMARINER

Oro

40 mm

Automático

PRECIO
\$30,500



OBARRIO



REF. 16618T

SUBMARINER

Acero / Oro

40 mm

Automático

PRECIO
\$12,500



OBARRIO



REF. 16613

SUBMARINER

Acero / Oro

40 mm

Automático

PRECIO
\$12,500



OBARRIO



CAJA



PAPELES



REF. 16613

SUBMARINER

Acero / Oro

40 mm

Automático

PRECIO
\$13,000





CDE



REF. 16613

AIR KING	DAYTONA	DATEJUST	DAY-DATE	EXPLORER	GMT-MASTER	MILGAUSS
OYSTER PERPETUAL	SEA-DWELLER	SKY-DWELLER	SUBMARINER	YACHT-MASTER	CELLINI	ORCHID

SUBMARINER

-  Oro
-  40 mm
-  Automático



PRECIO 
\$38,000

-  OBARRIO
-  CAJA
-  PAPELES



REF. 116618LN

SUBMARINER

-  Acero / Oro
-  40 mm
-  Automático

PRECIO 
\$16,500

-  OBARRIO
-  CAJA
-  PAPELES

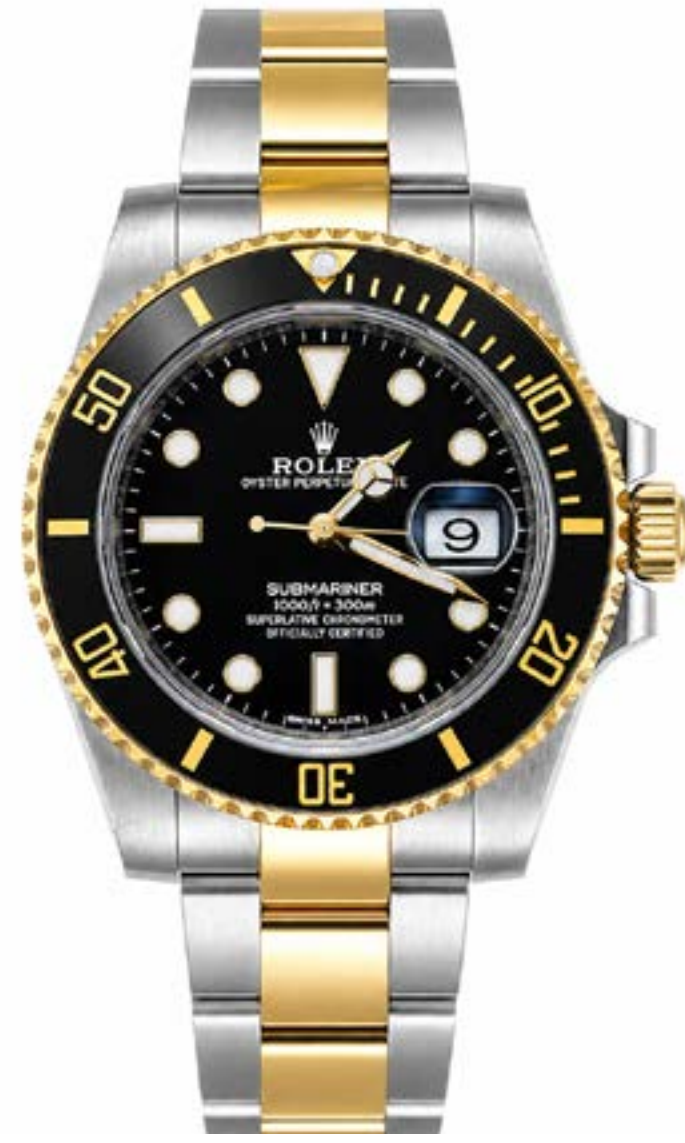

REF. 116613



AIR KING	DAYTONA	DATEJUST	DAY-DATE	EXPLORER	GMT-MASTER	MILGAUSS
OYSTER PERPETUAL	SEA-DWELLER	SKY-DWELLER	SUBMARINER	YACHT-MASTER	CELLINI	ORCHID

SUBMARINER

"SMURF"

 Oro Blanco

 40 mm

 Automático

PRECIO 
\$38,500



OBARRIO



REF. 116619

"SMURF"

Su distintiva esfera azul intensa y el bisel cerámico Cerachrom a juego le dan una estética única que recuerda a las profundidades marinas, de donde proviene su apodo Smurf (Pitufo).

Equipado con el legendario calibre automático 3135 - reconocido por su fiabilidad, precisión y movimiento certificado como cronómetro - este reloj ofrece función de fecha, resistencia al agua hasta 300 m y un diseño robusto pero elegante, ideal tanto para el buceo profesional como para la muñeca de un coleccionista exigente.



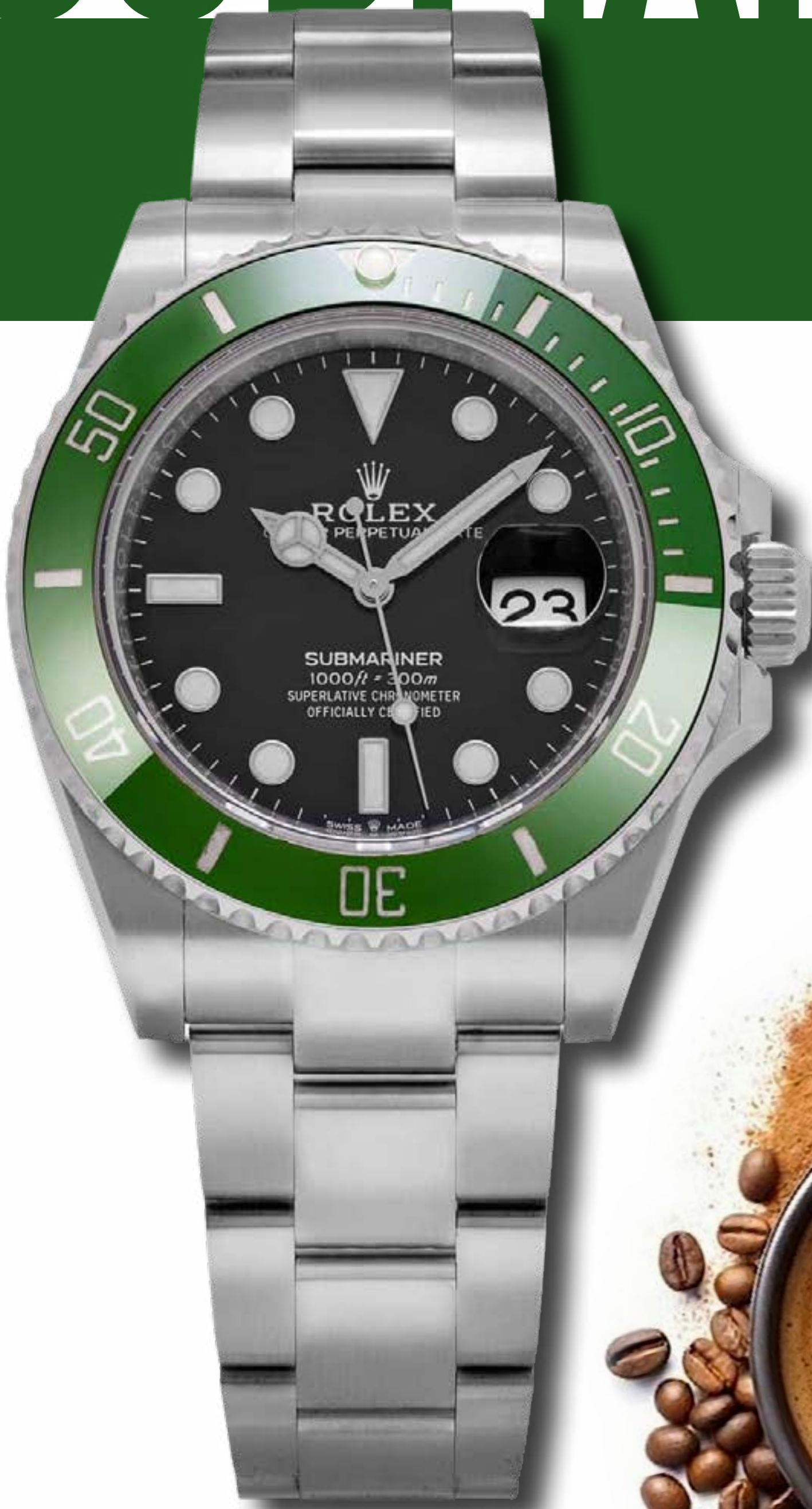

AIR KING	DAYTONA	DATEJUST	DAY-DATE	EXPLORER	GMT-MASTER	MILGAUSS
OYSTER PERPETUAL	SEA-DWELLER	SKY-DWELLER	SUBMARINER	YACHT-MASTER	CELLINI	ORCHID

SUBMARINER



STARBUCKS

-  Acero
-  40 mm
-  Automático

PRECIO 
\$17,800



REF. 126610LV

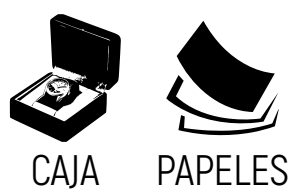

AIR KING	DAYTONA	DATEJUST	DAY-DATE	EXPLORER	GMT-MASTER	MILGAUSS
OYSTER PERPETUAL	SEA-DWELLER	SKY-DWELLER	SUBMARINER	YACHT-MASTER	CELLINI	ORCHID

SUBMARINER

KERMIT

"50 ANIVERSARIO"

- Acero
- 40 mm
- Automático

PRECIO 
\$12,500



OBARRIO



REF. 16610LV



SUBMARINER

KERMIT

"50 ANIVERSARIO"

- Acero
- 40 mm
- Automático

PRECIO 
\$12,500



CDE



CAJA



REF. 16610LV

SUBMARINER

KERMIT

- Acero
- 40 mm
- Automático

PRECIO 
\$12,000



OBARRIO



REF. 16610LV



SUBMARINER

KERMIT

- Acero
- 40 mm
- Automático

PRECIO 
\$12,500



OBARRIO



CAJA



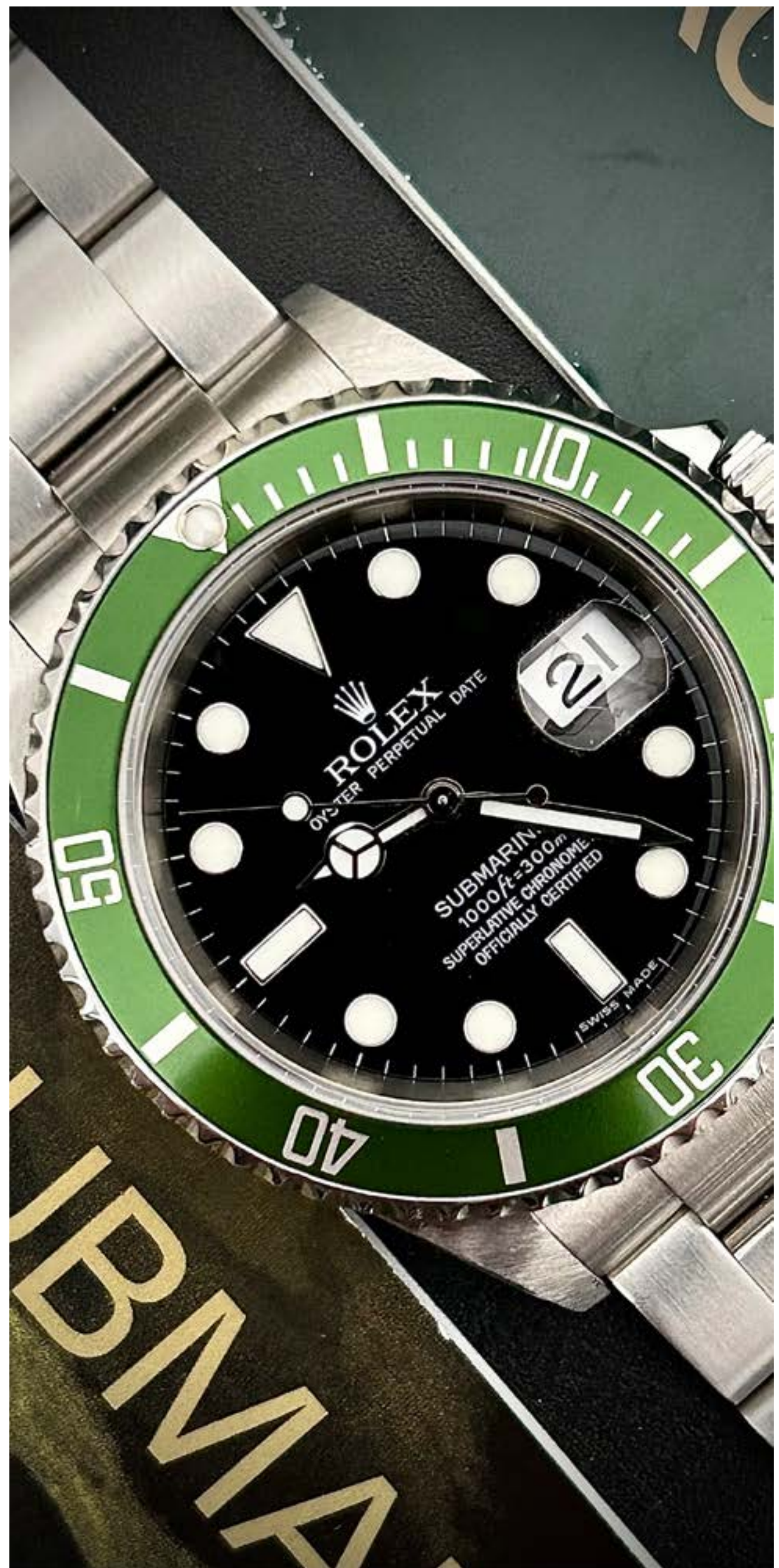

REF. 16610LV

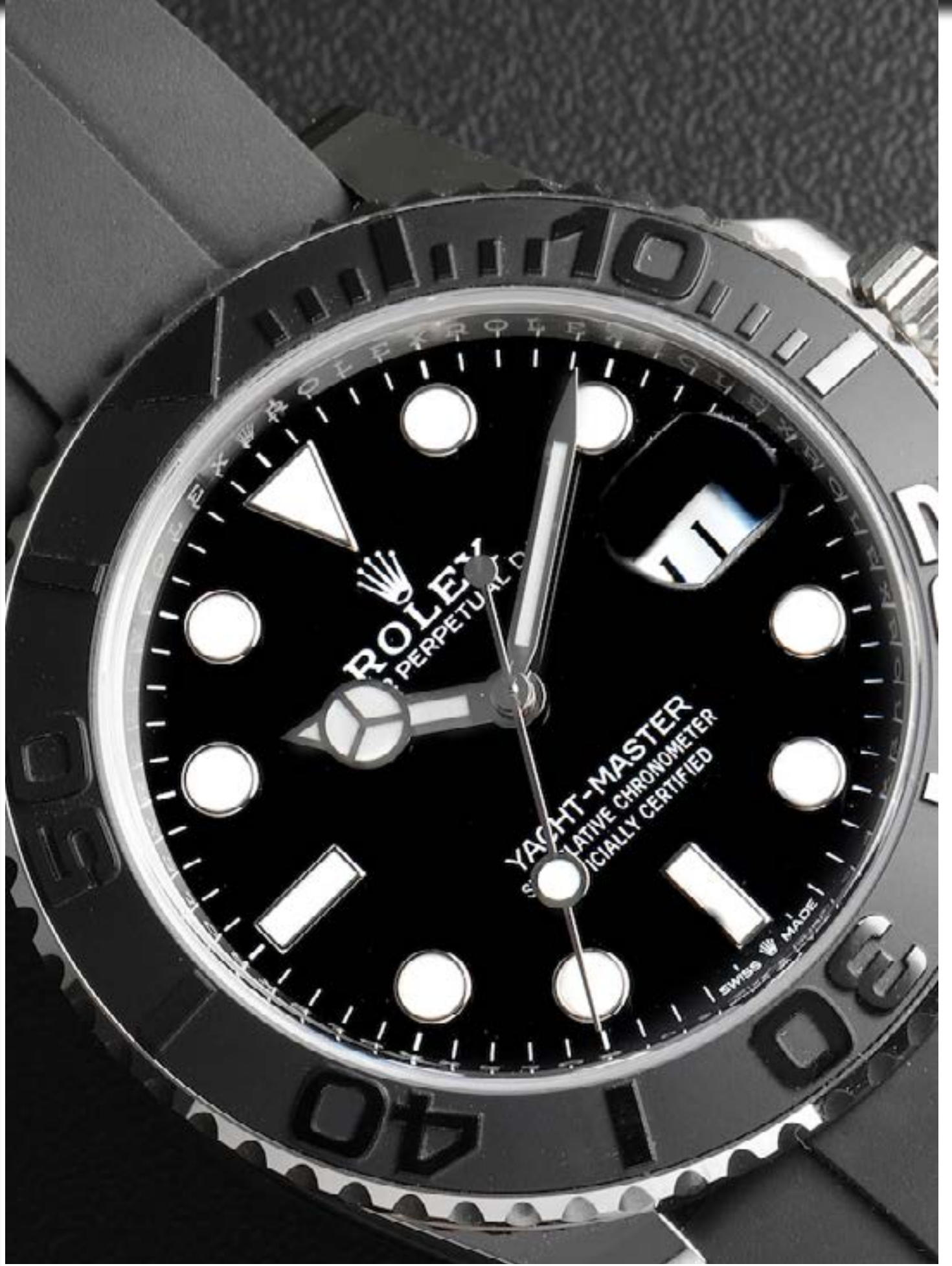

YACHT-MASTER II



-  Oro Blanco
-  42 mm
-  Automático

PRECIO 
\$32,000

REF. 226659

-  OBARRIO
-  CAJA
-  PAPELES



YACHT-MASTER II



 Acero / Oro Rosa

 44 mm

 Automático

PRECIO 
\$23,000

REF. 116681



CAJA

AIR KING	DAYTONA	DATEJUST	DAY-DATE	EXPLORER	GMT-MASTER	MILGAUSS
OYSTER PERPETUAL	SEA-DWELLER	SKY-DWELLER	SUBMARINER	YACHT-MASTER	CELLINI	ORCHID

YACHT-MASTER

- Acero / Oro
- 40 mm
- Automático

PRECIO 
\$13,500



OBARRIO

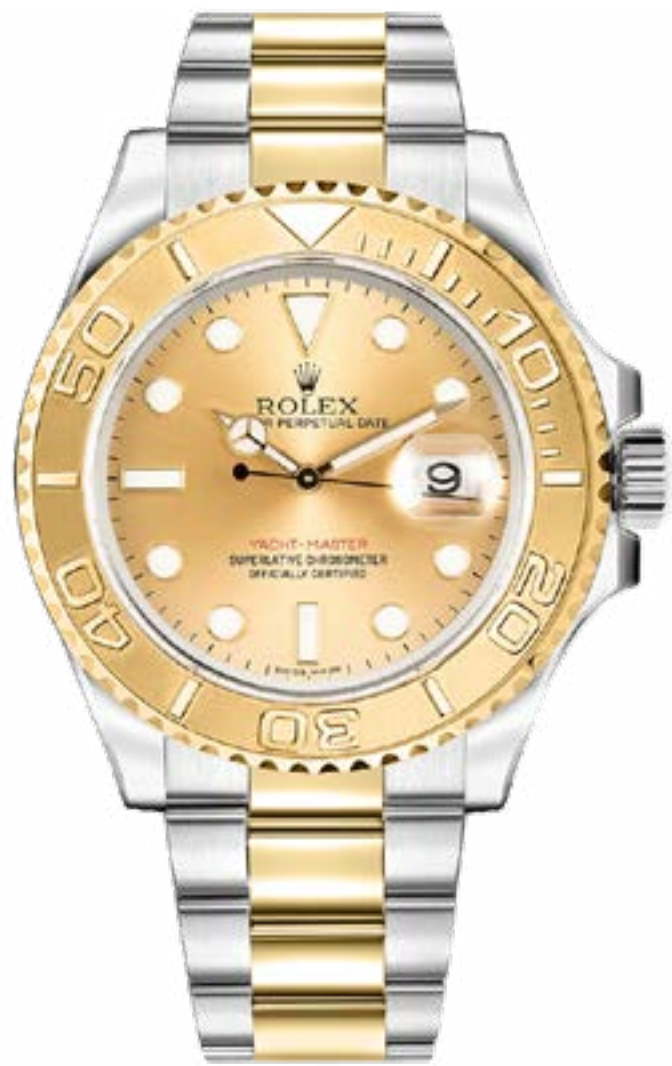

REF. 16623

YACHT-MASTER

- Acero / Oro
- 40 mm
- Automático

PRECIO 
\$13,800



CDE



CAJA

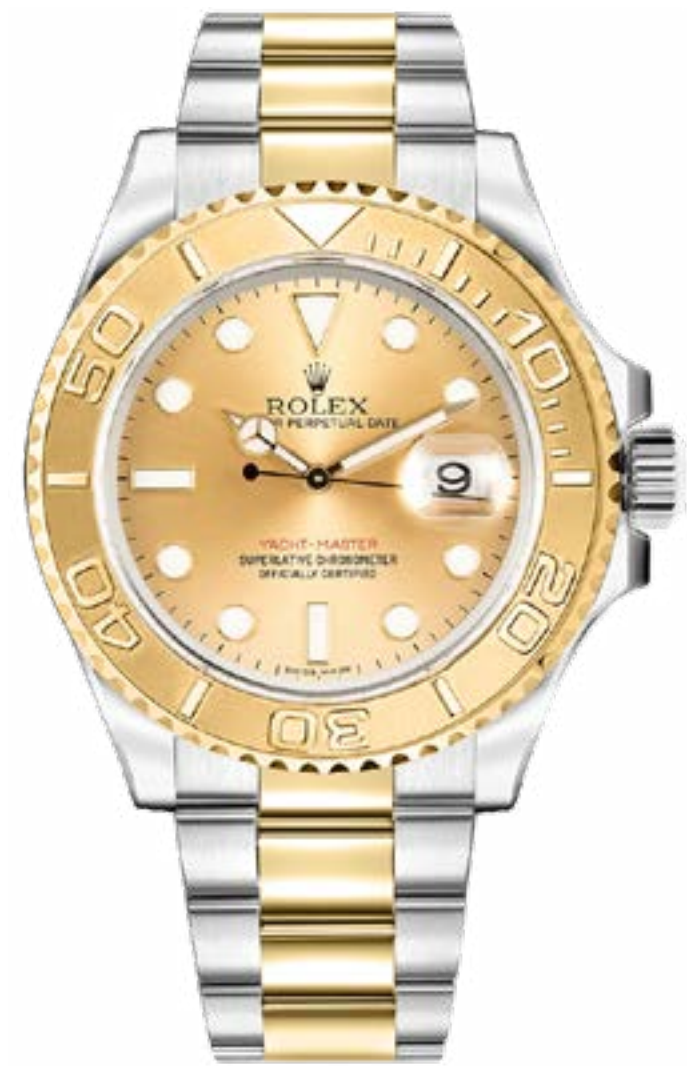

REF. 16623

YACHT-MASTER

"SERTI DIAL"

- Oro
- 40 mm
- Automático

PRECIO 
\$28,000



OBARRIO



REF. 16628

YACHT-MASTER

"SERTI DIAL"

- Oro Amarillo 18 k
- 35 mm
- Automático

PRECIO 
\$20,000



CDE



REF. 168628

YACHT-MASTER

"TAHITIAN DIAL"

- Oro
- 40 mm
- Automático

PRECIO 
\$35,000



OBARRIO



CAJA



PAPELES



REF. 16628

YACHT-MASTER

- Acero / Oro
- 40 mm
- Automático

PRECIO 
\$13,800



OBARRIO



CAJA



PAPELES





REF. 0000

AIR KING	DAYTONA	DATEJUST	DAY-DATE	EXPLORER	GMT-MASTER	MILGAUSS
OYSTER PERPETUAL	SEA-DWELLER	SKY-DWELLER	SUBMARINER	YACHT-MASTER	CELLINI	ORCHID

YACHT-MASTER II



-  Acero / Oro Rosa
-  44 mm
-  Automático

PRECIO 
\$24,500





CDE

REF. 116681

YACHT-MASTER II



-  Acero / Oro Rosa
-  44 mm
-  Automático

PRECIO 
\$22,500





OBARRIO

REF. 116681

YACHT-MASTER II



-  Acero / Oro Rosa
-  44 mm
-  Automático

PRECIO 
\$22,500



OBARRIO



REF. 116681

YACHT-MASTER II

"CANAL DE PANAMÁ"

"EDICIÓN LIMITADA" 150 PIEZAS



-  Acero
-  44 mm
-  Automático

PRECIO 
\$25,000





CDE

REF. 116680

YACHT-MASTER II



-  Acero / Oro Rosa
-  44 mm
-  Automático

PRECIO 
\$23,000



OBARRIO



CAJA



REF. 116681

YACHT-MASTER II

"CANAL DE PANAMÁ"

"EDICIÓN LIMITADA" 150 PIEZAS



-  Acero
-  44 mm
-  Automático

PRECIO 
\$23,500



OBARRIO



CAJA





PAPELES

REF. 116680

AIR KING	DAYTONA	DATEJUST	DAY-DATE	EXPLORER	GMT-MASTER	MILGAUSS
OYSTER PERPETUAL	SEA-DWELLER	SKY-DWELLER	SUBMARINER	YACHT-MASTER	CELLINI	ORCHID

YACHT-MASTER II

-  Acero
-  44 mm
-  Automático



PRECIO 
\$19,500

-  OBARRIO
-  CAJA
-  PAPELES



REF. 116680

YACHT-MASTER II

-  Acero
-  44 mm
-  Automático

PRECIO 
\$19,000



-  OBARRIO



REF. 116680



YACHT-MASTER

-  Oro Blanco
-  44 mm
-  Automático



PRECIO 
\$36,000

-  OBARRIO
-  CAJA



REF. 116689

YACHT-MASTER II

-  Oro Blanco
-  44 mm
-  Automático

PRECIO 
\$38,000



-  OBARRIO
-  CAJA
-  PAPELES



REF. 116689



YACHT-MASTER II

-  Oro Amarillo
-  44 mm
-  Automático

PRECIO 
\$44,500



-  OBARRIO
-  CAJA
-  PAPELES



REF. 116688

AIR KING	DAYTONA	DATEJUST	DAY-DATE	EXPLORER	GMT-MASTER	MILGAUSS
OYSTER PERPETUAL	SEA-DWELLER	SKY-DWELLER	SUBMARINER	YACHT-MASTER	CELLINI	ORCHID

YACHT-MASTER

-  Acero
-  40 mm
-  Automático



PRECIO 
\$9,800



REF. 16622



YACHT-MASTER

-  Acero
-  40 mm
-  Automático



PRECIO  \$12,500



REF. 16622



YACHT-MASTER

-  Acero
-  40 mm
-  Automático

PRECIO  \$13,000

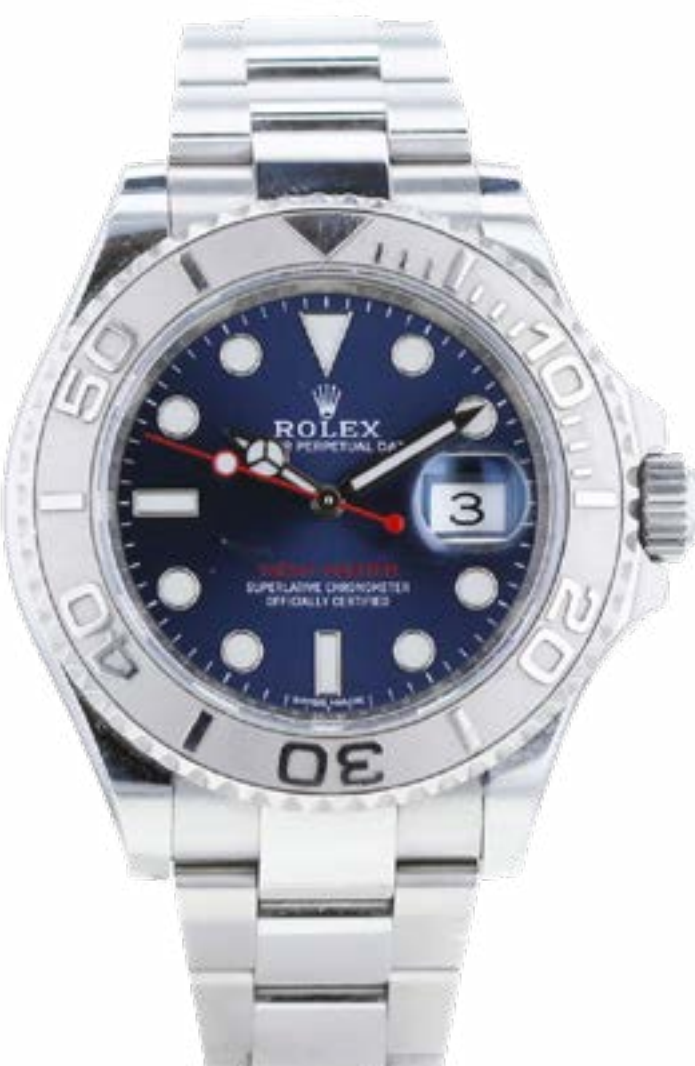

REF. 116622

AIR KING	DAYTONA	DATEJUST	DAY-DATE	EXPLORER	GMT-MASTER	MILGAUSS
OYSTER PERPETUAL	SEA-DWELLER	SKY-DWELLER	SUBMARINER	YACHT-MASTER	CELLINI	ORCHID

CELLINI

SERPICO Y LAINO

"VINTAGE"

-  Oro
-  32 mm
-  Cuerda Manual



PRECIO 
\$5,000



OBARRIO

REF. 8940

CELLINI

-  Oro Blanco
-  39 mm
-  Cuerda Manual



PRECIO 
\$13,000





CDE

REF. 50509

CELLINI

GENEVE

-  Oro Blanco
-  37 mm
-  Quartz



PRECIO 
\$16,500



OBARRIO





CAJA



PAPELES

REF. 6623

CELLINI

-  Oro blanco
-  32 mm
-  Automático





PRECIO 
\$5,500



OBARRIO

REF. 5116

CELLINI

-  Oro Amarillo
-  25 mm
-  Quartz



PRECIO 
\$20,000



OBARRIO



CAJA





PAPELES

REF. 5218

PRECISION

VINTAGE

-  Acero/Oro/Diamantes
-  16 mm
-  Quartz



PRECIO 
\$12,800



OBARRIO

REF. VINTAGE

AIR KING	DAYTONA	DATEJUST	DAY-DATE	EXPLORER	GMT-MASTER	MILGAUSS
OYSTER PERPETUAL	SEA-DWELLER	SKY-DWELLER	SUBMARINER	YACHT-MASTER	CELLINI	ORCHID

ORCHID



 Oro / Diamantes

 19 x 24 mm

 Cuerda Manual

PRECIO 

\$8,200



OBARRIO



CAJA



PAPELES

REF.

ORCHID





TAG Heuer
SWISS AVANT-GARDE SINCE 1860



Destacada por su precisión, innovación y estrecha relación con el automovilismo, TAG Heuer es una reconocida casa suiza de alta relojería, sus colecciones icónicas, como Carrera y Monaco, reflejan un enfoque técnico orientado al rendimiento y la medición del tiempo.

A lo largo de su historia, la marca ha impulsado avances en cronografía y diseño deportivo, consolidándose como un referente en relojería contemporánea.

AARON  **JOYEROS**

AQUARACER



-  Acero
-  43 mm
-  Quartz

PRECIO 
\$1,200



REF. CAF7011.BA0815



TAGHeuer
SWISS AVANT-GARDE SINCE 1860



ÍNDICE

AQUARACER	CARRERA	FÓRMULA 1	LINK	MONZA	MÓNACO
MOP DIAMOND	CHRONOMETER	PROFESSIONAL			



-  Acero / Oro
-  43 mm
-  Automático

REF. WAJ2150

PRECIO 
\$2,600

AQUARACER



TAG Heuer
SWISS AVANT-GARDE SINCE 1860



ÍNDICE

AQUARACER	CARRERA	FÓRMULA 1	LINK	MONZA	MÓNACO
MOP DIAMOND	CHRONOMETER	PROFESSIONAL			

AQUARACER

Acero y Oro

27 mm

Quartz

PRECIO
\$850



OBARRIO



REF. WAF1420

AQUARACER

Acero

39 mm

Quartz

PRECIO
\$650



OBARRIO



REF. WAF1110





TAGHeuer
SWISS AVANT-GARDE SINCE 1860



ÍNDICE

AQUARACER	CARRERA	FÓRMULA 1	LINK	MONZA	MÓNACO
MOP DIAMOND	CHRONOMETER	PROFESSIONAL			

CARRERA

- Acero
- 39 mm
- Automático

PRECIO
2,300

REF. WBN2112.BA0639





TAGHeuer
SWISS AVANT-GARDE SINCE 1860

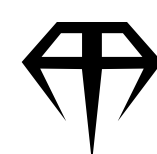

ÍNDICE

AQUARACER	CARRERA	FÓRMULA 1	LINK	MONZA	MÓNACO
MOP DIAMOND	CHRONOMETER	PROFESSIONAL			

CARRERA TITAN



OBARRIO



Titanio y Oro



45 mm



Automático

PRECIO 
\$5,400



TAGHeuer
SWISS AVANT-GARDE SINCE 1860

REF.

CAR2A5A.FT6044



TAGHeuer
SWISS AVANT-GARDE SINCE 1860

AQUARACER	CARRERA	FÓRMULA 1	LINK	MONZA	MÓNACO
MOP DIAMOND	CHRONOMETER	PROFESSIONAL			

CARRERA



- Acero / Oro
- 41 mm
- Automático

PRECIO \$3,000

OBARRIO

REF. CV2050-1



TAG Heuer
SWISS AVANT-GARDE SINCE 1860

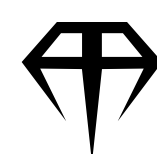

ÍNDICE

AQUARACER	CARRERA	FÓRMULA 1	LINK	MONZA	MÓNACO
MOP DIAMOND	CHRONOMETER	PROFESSIONAL			

CARRERA



REF. CAR2014.FC6235

- Acero
- 43 mm
- Automático

PRECIO
\$2,200



GRAND CARRERA CHRONOGRAPH



REF. CAV518B

- Acero
- 43 mm
- Automático

PRECIO
\$3,600



CARRERA

"Skeleton Black Dial"



REF. CAR201V.FT6087

- Acero
- 43 mm
- Automático

PRECIO
\$3,000



CARRERA



REF. WAR5010.BA0723

- Acero
- 41 mm
- Automático

PRECIO
\$2,200



CARRERA



REF. WBN2010

- Acero
- 41 mm
- Automático

PRECIO
\$3,000



CARRERA CALIBRE 8 GMT



REF. WAR5010.BA0723

- Acero
- 41 mm
- Automático

PRECIO
\$2,300





TAG Heuer
SWISS AVANT-GARDE SINCE 1860

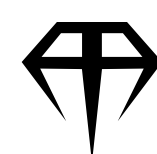

ÍNDICE

AQUARACER	CARRERA	FÓRMULA 1	LINK	MONZA	MÓNACO
MOP DIAMOND	CHRONOMETER	PROFESSIONAL			

CARRERA CHRONOGRAPH

- Acero
- 42 mm
- Automático

PRECIO
\$3,800



OBARRIO



REF. OBN2010

GRAND CARRERA

- Acero
- 42.5 mm
- Automático

PRECIO
\$2,350



CDE



REF. WAV5112.BA0901

CARRERA

- Acero
- 41 mm
- Automático

PRECIO
\$3,000



OBARRIO



CAJA



PAPELES



REF. WBN2013.FC6503

CARRERA

- Acero
- 41 mm
- Automático

PRECIO
\$2,200



OBARRIO



REF. WBN2013.FC6503

CARRERA

- Acero
- 39 mm
- Automático

PRECIO
\$1,800



OBARRIO



REF. WAS2112.FC6181

CARRERA

- Titanio
- 43 mm
- Automático

PRECIO
\$3,200



OBARRIO



REF. CAR2A80



TAGHeuer
SWISS AVANT-GARDE SINCE 1860



FÓRMULA 1



REF. CAZ101N.FC8243

-  Acero
-  43 mm
-  Quartz

PRECIO 
\$1,500



TAG Heuer
SWISS AVANT-GARDE SINCE 1860



CAJA PAPELES

Acero 38 mm Quartz

PRECIO \$1,550



FÓRMULA 1 SOLARGRAPH

REF. WBY1111.BA0042

AARON JOYEROS



TAG Heuer
SWISS AVANT-GARDE SINCE 1860



ÍNDICE

AQUARACER	CARRERA	FÓRMULA 1	LINK	MONZA	MÓNACO
MOP DIAMOND	CHRONOMETER	PROFESSIONAL			



FÓRMULA 1

REF. CAH1111.BA0850

-  Acero
-  41 mm
-  Quartz

PRECIO 
\$1,300



TAG Heuer
SWISS AVANT-GARDE SINCE 1860

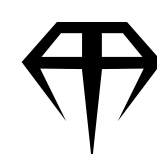

ÍNDICE

AQUARACER	CARRERA	FÓRMULA 1	LINK	MONZA	MÓNACO
MOP DIAMOND	CHRONOMETER	PROFESSIONAL			

FÓRMULA 1

LADY

Acero/Diamantes

37 mm

Quartz

PRECIO
\$2,100



OBARRIO



REF. WAC1218.BA0852

FÓRMULA 1

Acero y Cerámica

41 mm

Automático

PRECIO
\$1,400



OBARRIO



REF. CAH1213

FÓRMULA 1 - LADY

Acero

32 mm

Quartz

PRECIO
\$1,200



OBARRIO



REF. WBJ1418

FÓRMULA 1

Acero/Diamantes

37 mm

Automático

PRECIO
\$2,500



OBARRIO



CAJA



PAPELES



REF. WAU2213

FÓRMULA 1

DAVID GUETTA

Acero / Cuero

43 mm

Automático

PRECIO
\$2,000



OBARRIO



CAJA



REF. WAZ201A

FÓRMULA 1 - LADY

Acero

36 mm

Quartz

PRECIO
\$2,000



OBARRIO



REF. WAC1216-0



TAG Heuer

SWISS AVANT-GARDE SINCE 1860

AQUARACER	CARRERA	FÓRMULA 1	LINK	MONZA	MÓNACO
MOP DIAMOND	CHRONOMETER	PROFESSIONAL			



LINK

CALIBRE

- Acero
- 42 mm
- Automático

PRECIO

\$1,500



REF. WAT2011.BA0951





TAG Heuer
SWISS AVANT-GARDE SINCE 1860

AQUARACER	CARRERA	FÓRMULA 1	LINK	MONZA	MÓNACO
MOP DIAMOND	CHRONOMETER	PROFESSIONAL			

MONZA

CALIBRE 17

Acero / Cerámica

42 mm

Automático

PRECIO
\$4,000



OBARRIO



REF. CR2080

MÓNACO

Acero / Cuero

41 mm

Automático

PRECIO
\$4,200



OBARRIO



REF. WW2114

MOP DIAMOND

"DIAL MADRE PERLA"

Acero

28 mm

Quartz

PRECIO
\$1,200



OBARRIO



REF. WP131C

CHRONOMETER

Acero

38 mm

Automático

PRECIO
\$900



OBARRIO



REF. WH5115-KT

PROFESSIONAL

Acero

37 mm

Quartz

PRECIO
\$600



OBARRIO



REF. WL1112.BA0701

PROFESSIONAL

Acero

37 mm

Quartz

PRECIO
\$950



OBARRIO



REF. WK1112



TIFFANY & Co.

Tiffany & Co. es una icónica casa de lujo reconocida por su elegancia atemporal y su legado en la alta joyería. En relojería, sus creaciones combinan diseño sofisticado con precisión, reflejando un estilo refinado y distintivo.

Tiffany & Co. representa exclusividad, buen gusto y tradición dentro del universo del lujo.

ATLAS DOME



ACERO/CUERO

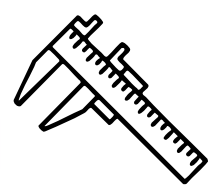

31 mm

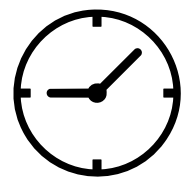

Quartz

PRECIO 
\$1,500

REF. Z1831.11.10B10A40A



TIFFANY & Co.

ATLAS

ACERO/ORO

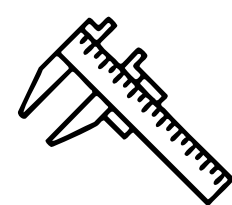

29 mm

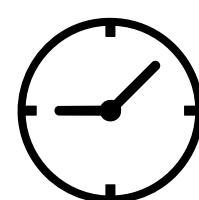

Quartz

PRECIO 
\$1,800



COSTA DEL
ESTE

REF. Z1800.68.15A21A00A

AARON  JOYEROS

TIFFANY & Co. CLASSIC

 Oro

 35 mm

 Automático

PRECIO 

\$5,000



OBARRIO



REF. M253





TUDOR

Tudor es una destacada casa suiza reconocida por ofrecer relojería de alto rendimiento con un enfoque robusto y accesible dentro del lujo. Sus modelos, inspirados en la herencia de su marca matriz, combinan fiabilidad, diseño deportivo y excelente relación calidad-precio.

Tudor representa resistencia, precisión y espíritu aventurero en la relojería contemporánea.

AARON  JOYEROS



TUDOR

BLACK BAY



Cerámica y Acero



41 mm

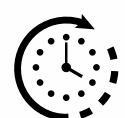

Automático

PRECIO



\$3,850



CAJA



PAPELES

REF.

M79210CNU-0001



OBARRIO



AARON  JOYEROS

DOUBLE DATE



CAJA



PAPELES

REF.

M57100-0001



Acero



42 mm



Automático



OBARRIO

PRECIO

\$3,000

AARON  JOYEROS

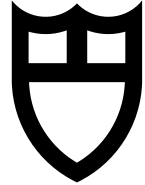
TUDOR





U-BOAT

U-Boat es una firma italiana reconocida por su diseño audaz y de gran tamaño, inspirado en instrumentos militares y de buceo. Sus relojes destacan por cajas robustas, coronas distintivas y una estética vintage-industrial muy marcada.

U-Boat representa carácter, originalidad y una presencia contundente dentro de la relojería contemporánea.

CLASSICO



Acero



53 mm



Automático

PRECIO



\$1,800

REF.

55780



OBARRIO





ULYSSE NARDIN
SINCE 1846  LE LOCLE - SUISSE

Ulysse Nardin es una histórica manufactura suiza reconocida por su innovación técnica y su estrecha relación con la navegación marina. Sus relojes destacan por la precisión, el desarrollo de complicaciones y el uso de tecnologías avanzadas.

Ulysse Nardin representa tradición, ingeniería y espíritu explorador dentro de la alta relojería.

AARON  JOYEROS

MARINE



- Acero / Caucho
- 40 mm
- Automático

PRECIO 
\$4,000



REF. 263-33

SAN MARCO



- Acero
- 38.5 mm
- Automático

PRECIO 
\$3,000



REF. 433-77

MAXI MARINE



- Acero
- 41 mm
- Automático

PRECIO 
\$3,800



REF. 353-66-314

DIVER



- Acero
- 44 mm
- Automático

PRECIO 
\$7,000



REF. 1183-170-3/92



VACHERON CONSTANTIN

Vacheron Constantin es una de las manufacturas más antiguas y prestigiosas de la alta relojería, reconocida por su excelencia artesanal, precisión y tradición ininterrumpida. Sus creaciones destacan por el desarrollo de complicaciones y acabados de alto nivel.

Vacheron Constantin representa elegancia, maestría y herencia dentro del universo más exclusivo de la relojería.



VACHERON CONSTANTIN



OVERSEAS

ORO AMARILLO



37 mm

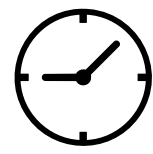

AUTOMÁTICO

PRECIO 
\$18,000

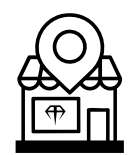

OBARRIO



REF.

42042/000J-8966





Van Cleef & Arpels

Chopard es una reconocida casa suiza que combina alta relojería y joyería con un enfoque en la elegancia, la innovación y la artesanía. Sus creaciones destacan por la atención al detalle y el uso de materiales de alta calidad.

A lo largo de su trayectoria, la marca ha desarrollado colecciones icónicas que equilibran técnica y estética, consolidando su presencia en el mundo del lujo. Chopard representa refinamiento, creatividad y excelencia dentro del universo relojero.



CÁRDENAS

 Oro Amarillo

 26 x 14 mm

 Quartz

PRECIO 
\$9,700

CDE



REF. 371505



Vintage

Esta selección de relojería vintage rinde tributo a la era dorada de la mecánica, donde la precisión y el arte se fusionaban en piezas de valor eterno. Estos ejemplares destacan por su manufactura artesanal en metales nobles y esferas de porcelana. Cada reloj de esta colección es un testimonio del ingenio humano, conservando la elegancia clásica que trasciende las modas pasajeras. Son joyas mecánicas que representan la máxima sofisticación de una época donde cada segundo se medía con distinción.

Vintage

WALTHAM

VINTAGE

Colección personal de Juan Vicente Gómez, representa la unión entre la precisión industrial y el poder político de principios del siglo XX. Con su esfera de porcelana blanca y caja de alta gama, esta pieza personifica la estética de sobriedad y mando que caracterizó al "Benemérito". Más que un instrumento para medir el tiempo, el ejemplar es un testigo patrimonial de la historia venezolana y de la fiabilidad técnica de una era dorada en la relojería norteamericana.

ORO 18k

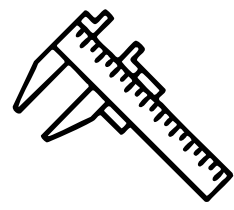

48 mm

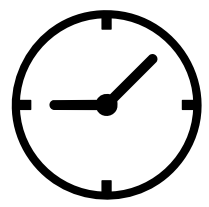

Cuerda manual

PRECIO 
\$20,000



REF.

VINTAGE



OBARRIO

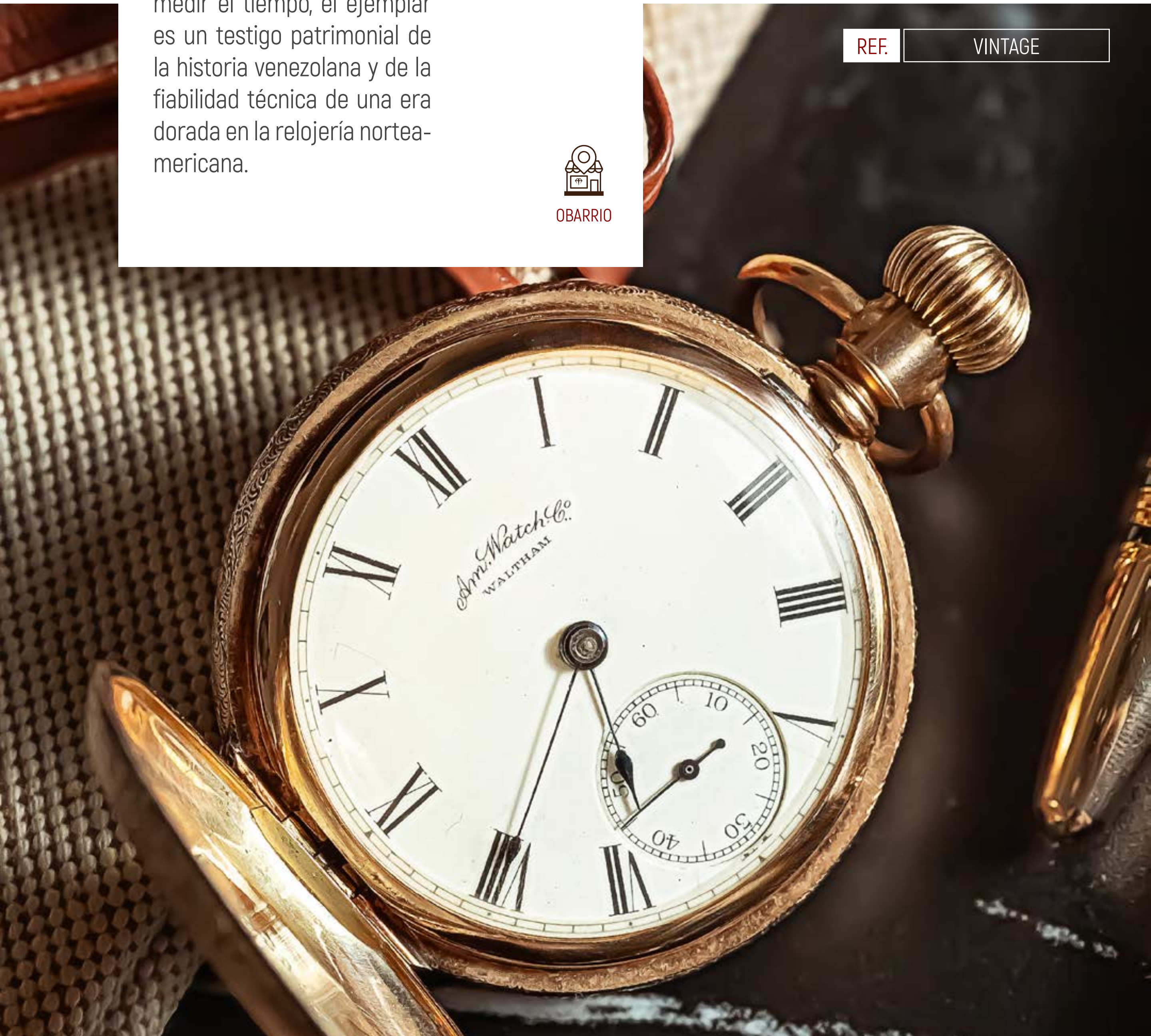

Vintage

OMEGA VINTAGE



REF. VINTAGE

- Acero
- 41 mm
- Quartz

PRECIO \$
\$1,500



OBARRIO

TUDOR VINTAGE



REF. VINTAGE

- Acero
- 17 mm
- Automático

PRECIO \$
\$800



OBARRIO

PRECISION VINTAGE



REF. VINTAGE

- Acero/Oro/Diamantes
- 16 mm
- Quartz

PRECIO \$
\$12,800



OBARRIO

OMEGA VINTAGE

"STRAP AFTER MARKET"



REF. VINTAGE

- Oro Rosa
- 36 mm
- Automático

PRECIO \$
\$4,000



OBARRIO

OMEGA CONSTELLATION



REF. 2652 SC

- Oro Amarillo
- 35 mm
- Quartz

PRECIO \$
\$4,000



OBARRIO

SEAMASTER DYNAMIC

"BISEL ORO"



REF. 196.0301 396.0993

- Acero
- 34 mm
- Quartz

PRECIO \$
\$1,000



OBARRIO

PIAGET CUERVOS Y SOBRINOS

- Acero
- 32 mm
- Automático

PRECIO 
\$500



OBARRIO



REF. VINTAGE

LONGINES

- Oro
- 32 mm
- Quartz

PRECIO 
\$3,500



OBARRIO



CAJA



REF. 1940

SEAMASTER VINTAGE

- Oro Amarillo
- 34 mm
- Quartz

PRECIO 
\$3,500



OBARRIO



REF. VINTAGE

SEAMASTER 1970

"DIAL SPIDER"

- Acero
- 43 x 46mm
- Automático

PRECIO 
\$9,000



OBARRIO



REF. 166.073

MUST VERMEIL 925

- Oro Amarillo
- 24 mm
- Quartz

PRECIO 
\$1,900



OBARRIO



REF. 590004

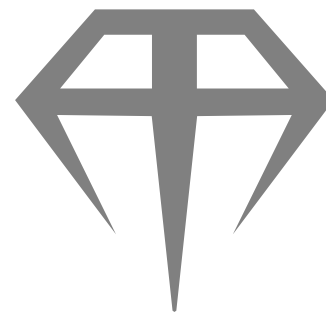

*Aquí comienza
su próxima gran elección.*



Boutique

OBARRIO



Boutique

COSTA DEL ESTE