



CATÁLOGO INTERACTIVO

AARON  JOYEROS

ÍNDICE

Interactivo

BIENVENIDO A UNA EXPERIENCIA DE LUJO Y PRECISIÓN

Este catálogo interactivo ha sido diseñado para que explores nuestras colecciones de diamantes, bolígrafos y relojes de manera intuitiva y dinámica.



RELOJES

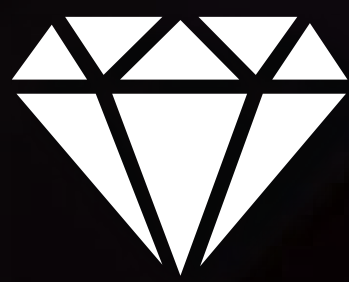

DIAMANTES



BOLÍGRAFOS

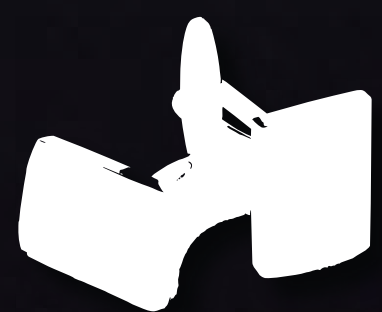

MANCUERNAS

Haz **clic** en cada ícono de categoría para descubrir piezas seleccionadas con los más altos estándares de calidad, autenticidad y distinción. Cada sección te permitirá navegar fácilmente entre detalles, especificaciones y opciones disponibles.



índice

CATÁLOGO TOUCH

Toca la marca de tu preferencia para navegar por nuestras exclusivas selecciones

AP
AUDEMARS PIGUET
Le maître de l'horlogerie depuis 1875

CHAUMET
PARIS

GUCCI

PIAGET

Alain Silberstein®

Chopard
GENÈVE

HAMILTON

RW
RAYMOND WEIL
GENÈVE

AZIMUT

CONCORD

HARRY WINSTON

REVUE THOMMEN
Since 1853

BALL

CORUM

 HUBLOT

ROGER DUBUIS

BAUME & MERCIER
MAISON D'HORLOGERIE GENEVE 1830

DEVON

IWC
SCHAFFHAUSEN

ROLEX

JB
1735
BLANCPAIN

DUMOREAU

JAEGER-LECOULTRE

TAGHeuer
SWISS AVANT-GARDE SINCE 1860

Bell & Ross

EBEL

LONGINES

TIFFANY & Co.

BOUCHERON
PARIS

EBERHARD & Co

MONT
BLANC

TISSOT

Breguet
Depuis 1775

EDOX

MAURICE  LACROIX
Manufacture Horlogère Suisse

TUDOR

BREITLING
1884

FENDI

OMEGA

U-BOAT

BVLGARI

FREDERIQUE CONSTANT
GENÈVE

ORIS
HÖLSTEIN 1904

ULYSSE NARDIN
SINCE 1846  LE LOCLE - SUISSE

Cartier

GP
GIRARD-PERREGAUX

PANERAI

VACHERON CONSTANTIN
GENÈVE

CHANEL

GRAHAM
LONDON

CHARRIOL
GENÈVE

Van Cleef & Arpels

Vintage

AARON  JOYEROS

JOYERIA & RELOJERIA

CÓMO LLEGAR a nuestras Boutiques?

Haz clic en el ícono o el QR para ir a **Google Maps**.



Boutique
OBARRIO

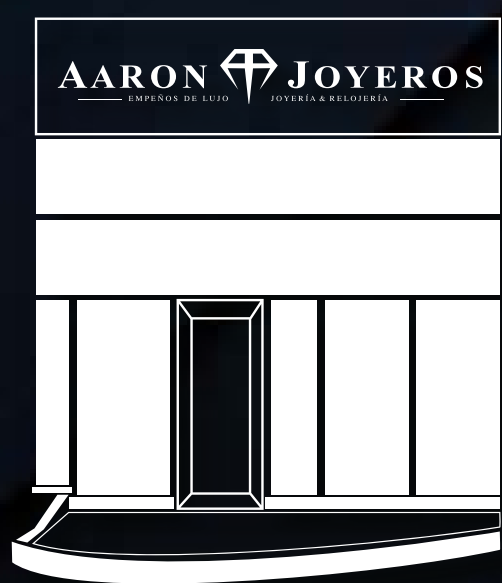

Boutique
COSTA DEL

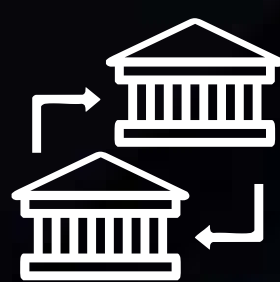

Transferencia
Bancaria

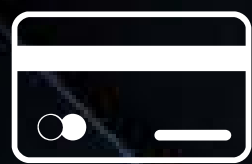

Tarjeta de
Crédito



Tarjeta
Clave



Cheques



6225-5554

Whatsapp



aronjoyerospty

Compramos y vendemos relojes y joyería 100% original.
NO SOMOS DISTRIBUIDOR AUTORIZADO.
Precios sujetos a cambios.

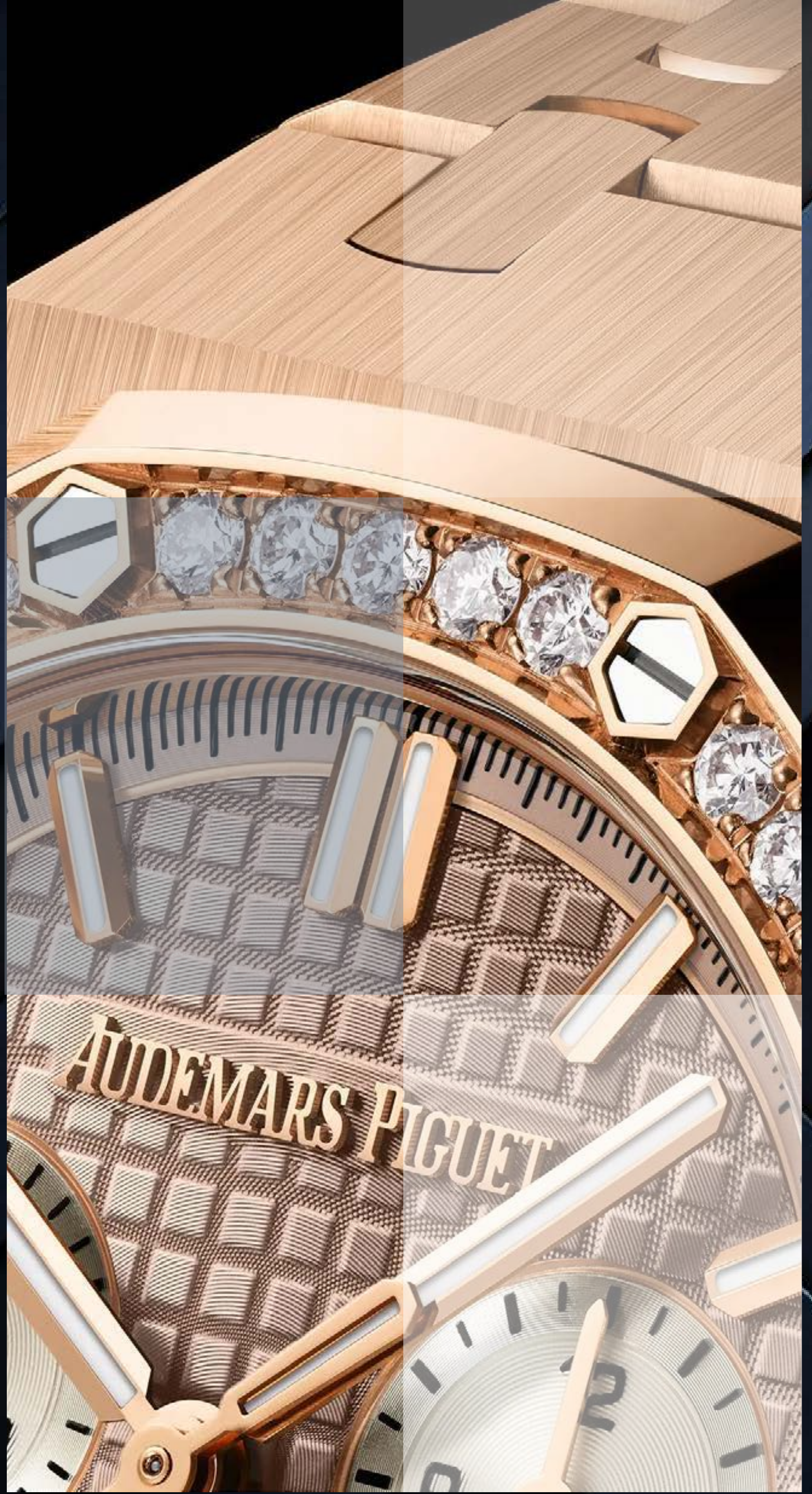

AP
AUDEMARS PIGUET
Le maître de l'horlogerie depuis 1875

Fundada en 1875 y reconocida por su independencia, innovación técnica y excelencia artesanal. Ha destacado por el desarrollo de complicaciones de alto nivel y por revolucionar el diseño relojero con piezas icónicas como el Royal Oak. Su enfoque combina tradición, ingeniería avanzada y una estética audaz, representando exclusividad y vanguardia en la alta relojería.

ROYAL OAK



-  ORO ROSA
-  44 mm
-  AUTOMÁTICO

PRECIO
 \$40,000



REF. 26401RO.00.A

ROYAL OAK

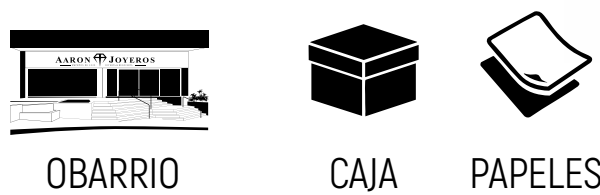

-  ORO ROSA
-  44 mm
-  AUTOMÁTICO

PRECIO
 \$42,000



REF. 26401RO.00.A

ROYAL OAK VOLCANO

-  ACERO
-  42 mm
-  AUTOMÁTICO

PRECIO
 \$20,000



REF. 26170ST. 00.D101CR.01

ROYAL OAK

-  ORO / DIAMANTES
-  29 X 38 mm
-  QUARTZ

PRECIO
 \$24,000



REF. 6005BA

VINTAGE

-  ORO AMARILLO
-  30.5 mm
-  QUARTZ

PRECIO
 \$15,000



REF. AP03022201X

VINTAGE

-  ORO AMARILLO
-  32 mm
-  QUARTZ

PRECIO
 \$24,000



REF. VINTAGE



Alain Silberstein[®]

Fundada en 1875 y reconocida por su independencia, innovación técnica y excelencia artesanal. Ha destacado por el desarrollo de complicaciones de alto nivel y por revolucionar el diseño relojero con piezas icónicas como el Royal Oak. Su enfoque combina tradición, ingeniería avanzada y una estética audaz, representando exclusividad y vanguardia en la alta relojería.

AARON  JOYEROS

Alain Silberstein®

ÍNDICE



KRONO BAUHAUS 2

TITANIUM



45 mm



AUTOMÁTICO



CAJA



PAPELES

PRECIO

\$14,000

REF.

MVK 0301 B



OBARRIO

AARON JOYEROS

JOYERIA & RELOJERIA



AZIMUTH

Azimuth es una marca de relojería independiente reconocida por sus diseños futuristas, creatividad mecánica y enfoque poco convencional dentro de la alta relojería contemporánea. Sus relojes destacan por complicaciones originales, indicaciones innovadoras del tiempo y una estética audaz inspirada en la ingeniería, la ciencia ficción y el automovilismo, convirtiéndose en piezas exclusivas para coleccionistas que buscan originalidad y carácter.

AARON  JOYEROS

GRAN TURISMO

BLACK PVD



ACERO

50 mm

AUTOMÁTICO

PRECIO
\$3,000



OBARRIO



AZ.GT.BLKPVD

REF.



BALL

Ball Watch Company es una marca suiza reconocida por su precisión y resistencia, con raíces en la relojería ferroviaria estadounidense. Sus relojes destacan por su durabilidad y el uso de microtubos de gas que garantizan una excelente visibilidad en la oscuridad.

Ball representa fiabilidad, ingeniería y rendimiento dentro de la relojería técnica.

BALL

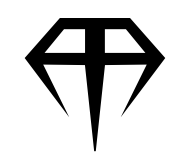

ÍNDICE



ENGINEER III MARVELIGHT CHRONOMETER

REF. NM9026C-S44C-TQR



ACERO



43 mm



AUTOMÁTICO

PRECIO

\$2,000



OBARRIO



CAJA



PAPELES



AARON  JOYEROS

CAPELAND CHRONOGRAPH

 ACERO

 43 mm

 AUTOMÁTICO

PRECIO
\$1,500



OBARRIO



CAJA



REF.

CM1030D





BAUME & MERCIER
MAISON D'HORLOGERIE GENEVE 1830



Reconocida por su elegancia equilibrada y su enfoque accesible dentro del lujo, Baume & Mercier se posiciona como una distinguida casa suiza de alta relojería. Sus colecciones, como Classima y Clifton, reflejan un estilo clásico con matices contemporáneos, enfocado en la sobriedad y la precisión.

A lo largo de su trayectoria, la marca ha mantenido un firme compromiso con la calidad y el diseño refinado, creando piezas versátiles para el día a día. Baume & Mercier representa armonía, fiabilidad y elegancia atemporal en la relojería suiza.

AARON  JOYEROS

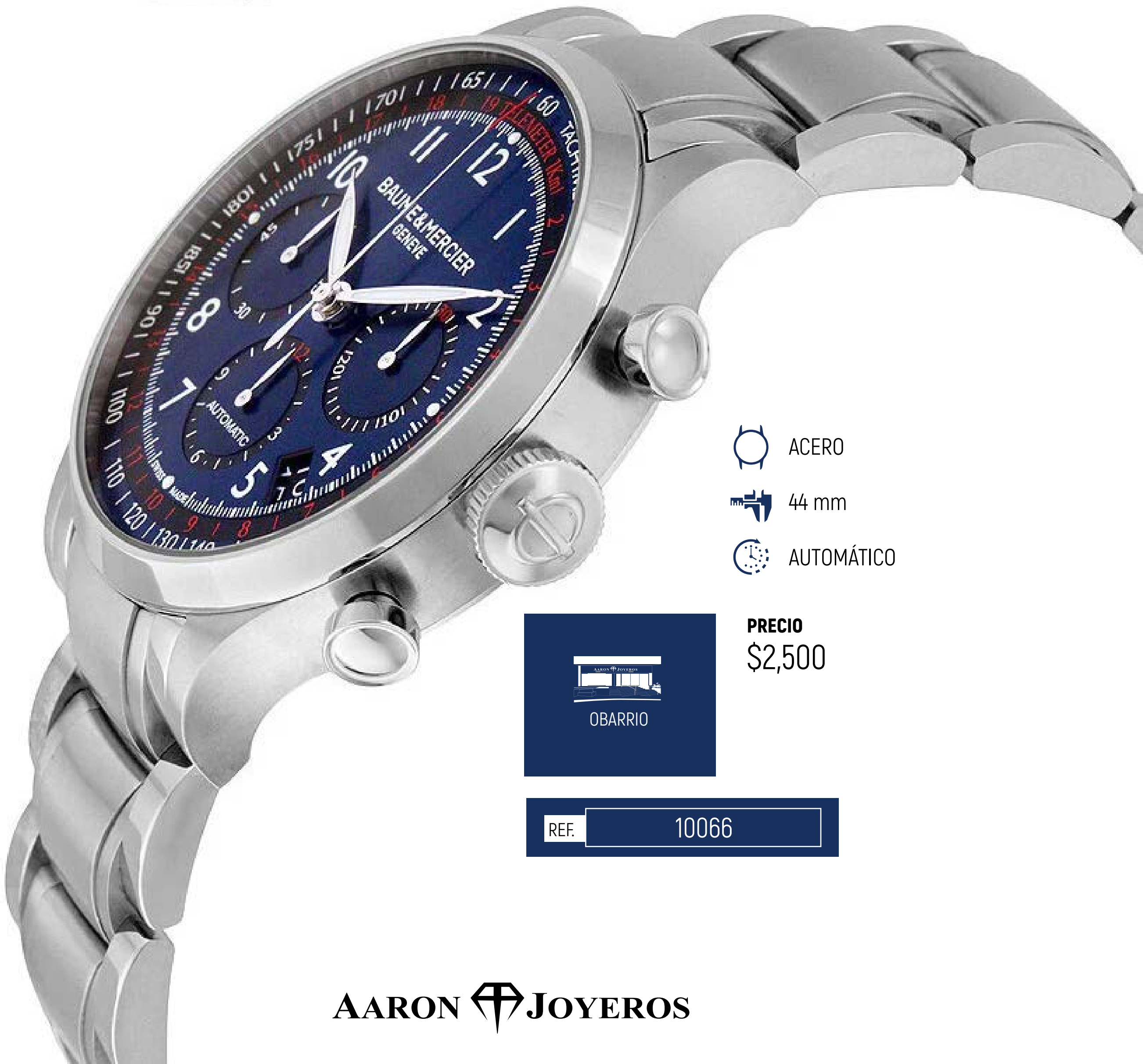
CHRONOGRAPH





-  ACERO
-  44 mm
-  AUTOMÁTICO



PRECIO
\$2,500

REF. 10066

RIVIERA

-  ACERO
-  43 mm
-  AUTOMÁTICO

PRECIO
\$1,800





OBARRIO



REF. 65541

RIVIERA

-  ACERO
-  38 mm
-  AUTOMÁTICO

PRECIO
\$1,500



OBARRIO



CAJA





PAPELES



REF. 26310R.00

RIVIERA

-  ACERO
-  43 mm
-  AUTOMÁTICO

PRECIO
\$1,500





OBARRIO



REF. 65541

CLASSIMA

-  ORO
-  24 mm
-  QUARTZ

PRECIO
\$1,800





OBARRIO



REF. MV045088

RECTANGLE MOTHERS OF PEARLS

-  ACERO / ORO
-  22 X 33 mm
-  QUARTZ

PRECIO
\$800



OBARRIO



REF. 8600

VINTAGE

-  ACERO
-  27 mm
-  QUARTZ

PRECIO
\$1,800



OBARRIO



REF. 65347

HAMPTON SPIRIT

"DIAL MADRE PERLA"

-  ACERO
-  30 X 31 mm
-  QUARTZ

PRECIO
\$1,000



COSTA DEL ESTE CAJA PAPELES



REF. MOA08450

TANK

-  ACERO
-  22 x 33 mm
-  QUARTZ

PRECIO
\$2,500



OBARRIO



REF. 97256

HAMPTON CHRONOGRAPH

-  ACERO
-  29 X 44 mm
-  QUARTZ

PRECIO
\$1,000



OBARRIO



REF. 65341

CATWALK

-  ACERO / DIAMANTES
-  21 mm
-  QUARTZ

PRECIO
\$650





OBARRIO



REF. MV045219

HAMPTON

-  ACERO
-  32 mm
-  AUTOMÁTICO

PRECIO
\$950





OBARRIO



REF. 65697

CLIFTON GMT

-  ACERO
-  43 mm
-  AUTOMÁTICO

PRECIO
\$1,500



OBARRIO



REF. MOA10112

HAMPTON
CRONÓGRAFO

-  ACERO
-  34 x 29 mm
-  QUARTZ

PRECIO
\$700





OBARRIO

REF. 65341



HAMPTON

-  ACERO
-  42 x 39 mm
-  AUTOMÁTICO

PRECIO
\$575





OBARRIO

REF. 65402



CLASSIMA
EXECUTIVE

-  ORO
-  38 mm
-  AUTOMÁTICO

PRECIO
\$7,000



OBARRIO

REF. 65627



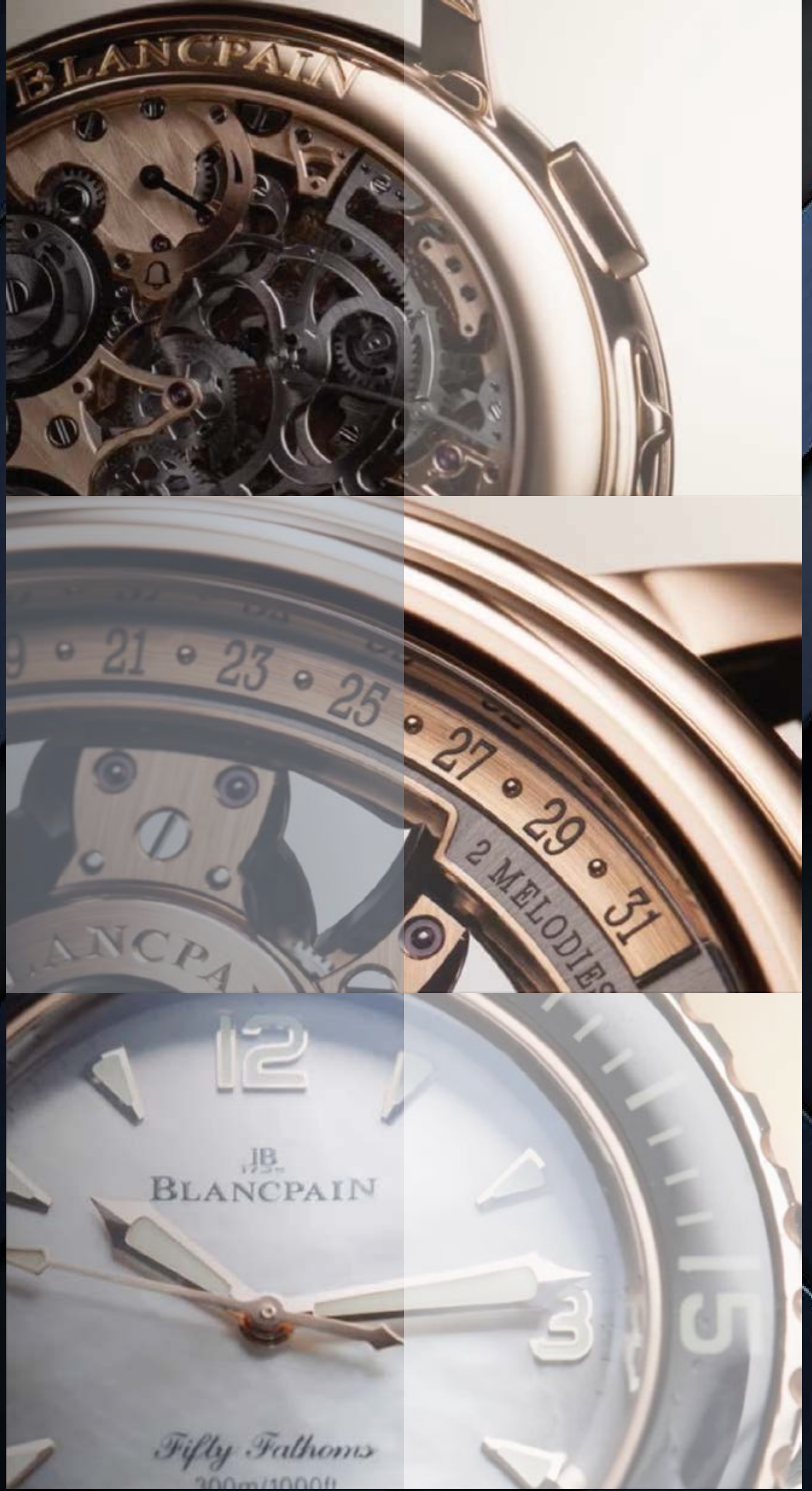



JB
1735
BLANCPAIN
MANUFACTURE DE HAUTE HORLOGERIE

Blancpain es una de las casas más emblemáticas de la alta relojería, reconocida por su profunda tradición, innovación mecánica y compromiso con la artesanía. Ha destacado por la creación de relojes de gran complejidad y por modelos icónicos como el Fifty Fathoms. Su enfoque une herencia, precisión y elegancia atemporal, representando exclusividad y excelencia relojera.



VILLERET



-  ORO BLANCO / DIAMANTES
-  40 mm
-  AUTOMÁTICO

PRECIO
\$12,500

REF. 4063-1560-55



GMT
FIFTY FATHOMS

 ACERO

 40.5 mm

 AUTOMÁTICO

PRECIO
\$7,500



OBARRIO



REF. 2250.1130.71





Bell & Ross

Bell & Ross es una firma reconocida por su diseño inspirado en la aviación y los instrumentos aeronáuticos, combinando funcionalidad, precisión y estética contemporánea. Sus relojes destacan por cajas cuadradas icónicas, legibilidad excepcional y un enfoque técnico que refleja innovación, carácter y espíritu militar moderno.



AARON  JOYEROS

PHANTOM

ÍNDICE

Bell & Ross



-  ACERO
-  42 mm
-  AUTOMÁTICO

PRECIO
\$2,400



REF. BR0392-BL-CE



OBARRIO



Bell & Ross

AVIATION



REF. BR01-92-SHE

REF.

-  ACERO
-  46 mm
-  AUTOMÁTICO

PRECIO
\$3,300



OBARRIO





BOUCHERON
PARIS

Boucheron es una histórica casa parisina reconocida por su excelencia en alta joyería y su enfoque artístico en la relojería. Sus creaciones combinan diseño innovador, elegancia y un fuerte carácter estético.

Boucheron representa creatividad, sofisticación y savoir-faire dentro del universo del lujo.

AARON  JOYEROS

REFLET DIAMANTE



 ACERO

 18 x 29 mm

 QUARTZ

PRECIO
\$1,200

REF. 20 30 53



OBARRIO



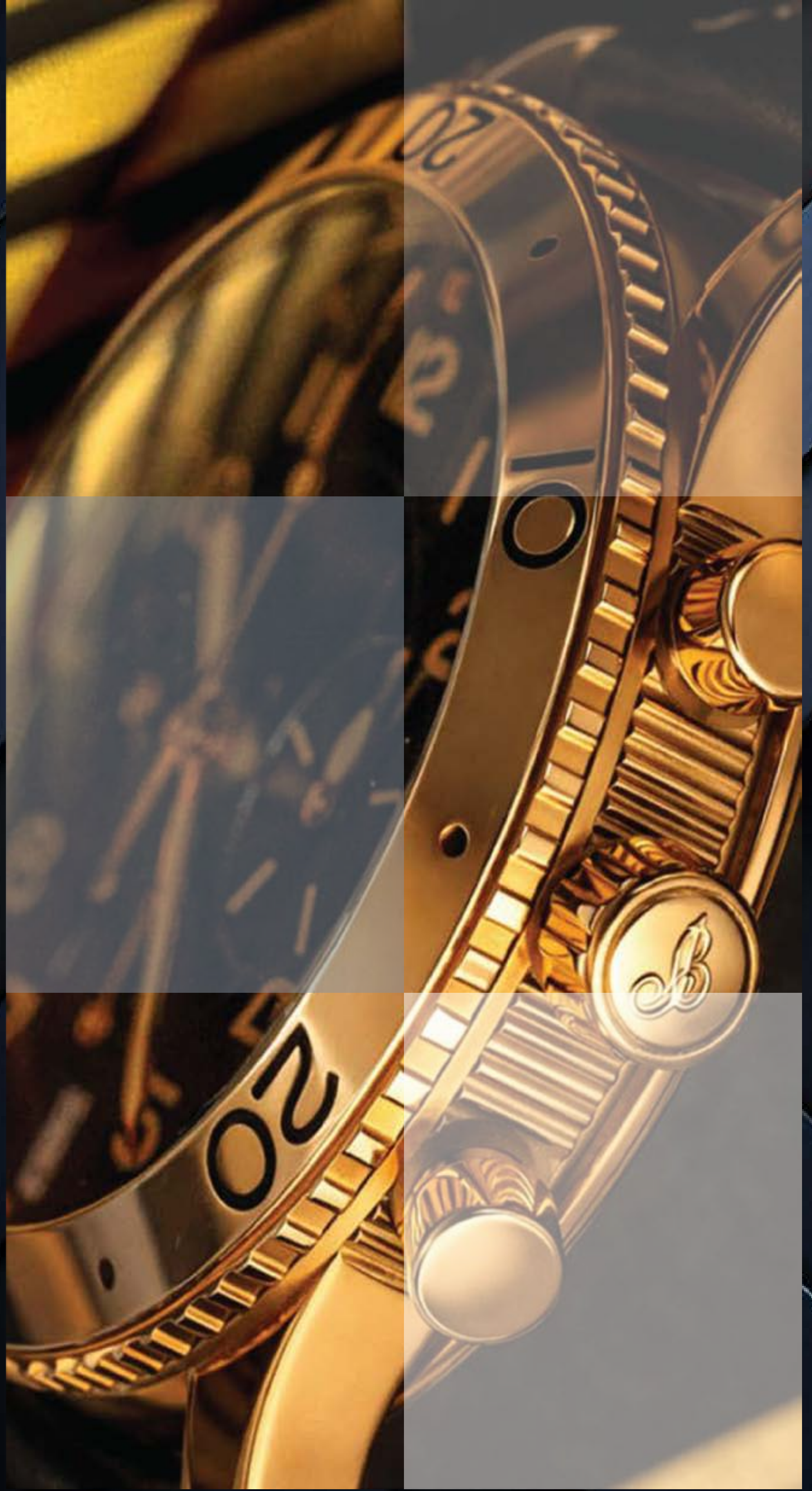

Breguet
Depuis 1775

Breguet es una de las casas más influyentes en la historia de la relojería, reconocida por su innovación, elegancia y legado técnico. Sus creaciones se distinguen por detalles clásicos como las agujas Breguet y esferas guilloché, reflejando un estilo refinado y atemporal.

Breguet representa tradición, sofisticación y una profunda contribución al desarrollo de la alta relojería.

AARON  JOYEROS

AERONAVALE

 ORO ROSA / CUERO

 39 mm

 AUTOMÁTICO

PRECIO
\$18,600



OBARRIO



REF. 3800





BREITLING
1884

Reconocida casa suiza de alta relojería, destacada por su precisión, innovación y fuerte vínculo con la aviación. Ha sobresalido por el desarrollo de cronógrafos profesionales y modelos icónicos como el Navitimer. Su enfoque combina rendimiento, funcionalidad y diseño robusto, representando espíritu técnico y excelencia en relojería deportiva.

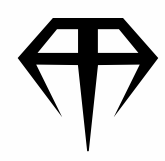

ÍNDICE



BREITLING
1884

NAVITIMER B03

CHRONOGRAPH RATTRAPANTE 45



ACERO

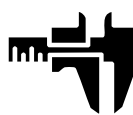

45 mm

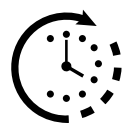

AUTOMÁTICO

PRECIO

\$7,800



OBARRIO



CAJA



PAPELES

REF.

AB03102A1F1A1

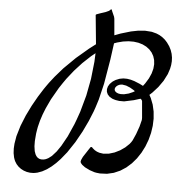

BREITLING
1884



ÍNDICE



OBARRIO

NAVITIMER CHRONOGRAPH



ACERO



45 mm



AUTOMÁTICO

PRECIO

\$7,000



CAJA



PAPELES

REF. AB031021/Q615



REF.

B
BREITLING
1884



CHRONOMAT 44

RAVEN

-  ACERO
-  44 mm
-  AUTOMÁTICO

PRECIO
\$4,800



COSTA DEL ESTE

REF. REF. MB0111C2

AVENGER SEAWOLF

- ACERO
- 45 mm
- AUTOMÁTICO

PRECIO
\$2,600



OBARRIO



REF. A17330

STARLINER

"DIAL AZUL MADRE PERLA"

- ACERO
- 30 mm
- QUARTZ

PRECIO
\$2,800



OBARRIO



REF. A71340

NAVITIMER

- ACERO
- 38 mm
- AUTOMÁTICO

PRECIO
\$3,200



COSTA DEL ESTE



REF. A17325211C1P3

AVENGER

- ACERO
- 44 mm
- AUTOMÁTICO

PRECIO
\$3,500



OBARRIO



REF. A32320

SUPER AVENGER

- ACERO
- 45 mm
- AUTOMÁTICO

PRECIO
\$3,500



OBARRIO



REF. A73321

SUPER OCEAN

- ACERO
- 44 mm
- AUTOMÁTICO

PRECIO
\$4,000



COSTA DEL ESTE



REF. A13341

CHRONOMANT EVOLUTION

ACERO / ORO

44 mm

AUTOMÁTICO

PRECIO
\$6,800



OBARRIO



REF. CB0110

COCKPIT B50 NIGHT MISSION

TITANIO

46 mm

QUARTZ

PRECIO
\$4,800



OBARRIO



REF. VB501022.BD41

ENDURANCE PRO

CARBONO

44 mm

QUARTZ

PRECIO
\$2,600



OBARRIO



CAJA



PAPELES



REF. X82310A51B1S1

COCKPIT

"NUEVO A ESTRENAR"

ACERO

45 mm

QUARTZ

PRECIO
\$4,800



OBARRIO



CAJA



PAPELES



REF. VB5010

CHRONO COCKPIT

ACERO / ORO

39 mm

AUTOMÁTICO

PRECIO
\$3,000



OBARRIO



REF. B13358

EXOSPACE

TITANIO

46 mm

QUARTZ

PRECIO
\$4,500



OBARRIO



REF. VB5510

CHRONOMAT

- ACERO
- 47 mm
- AUTOMÁTICO

PRECIO
\$4,200



OBARRIO



REF. AB0412



AVENGER

- TITANIO
- 44 mm
- AUTOMÁTICO

PRECIO
\$3,000



OBARRIO



REF. E13360

SUPER AVENGER

- ACERO
- 48 mm
- AUTOMÁTICO

PRECIO
\$3,800



OBARRIO



REF. A13370

COLT GMT

- ACERO
- 40.5 mm
- AUTOMÁTICO

PRECIO
\$2,200



OBARRIO



REF. A3235011

GALACTIC 36 SLEEK

- ACERO
- 36 mm
- AUTOMÁTICO

PRECIO
\$2,300



COSTA DEL ESTE



REF. W74330

BENTLEY
WRISTWATCH

- TITANIO
- 49 mm
- AUTOMÁTICO

PRECIO
\$6,000



OBARRIO



REF. E273622/BC63

COLT CHRONOGRAPH

- ACERO
- 41 mm
- QUARTZ

PRECIO
\$2,000



OBARRIO



REF. A73380

LADY J

- ACERO
- 31 mm
- QUARTZ

PRECIO
\$2,500



OBARRIO



REF. D52065

AVENGER

- ACERO
- 43 mm
- AUTOMÁTICO

PRECIO
\$3,500



OBARRIO



CAJA



PAPELES



REF. A17318

AEROSPACE

- ORO
- 40 mm
- QUARTZ

PRECIO
\$7,000



OBARRIO



REF. K65062



BVLGARI

Bvlgari destaca en la alta relojería por su enfoque creativo y su capacidad de reinterpretar el diseño clásico con una estética contemporánea. Reconocida por piezas emblemáticas como el Octo, ha logrado unir ingeniería suiza con una fuerte identidad italiana. Sus creaciones reflejan innovación, carácter arquitectónico y una visión moderna del lujo relojero.

BVLGARI



REF. DGP40C6GLDGMT



DIAGONO

-  ORO ROSA
-  40 mm
-  AUTOMÁTICO



OBARRIO



PRECIO
\$14,500

GMT

DIAGONO



REF. 42 SC CH

-  Acero
-  Automático
-  42 mm

PRECIO 
\$7,000





OBARRIO

DIAGONO GMT



REF. DP42SGMT

-  Acero
-  42 mm
-  Automático

PRECIO 
\$4,500





OBARRIO

DANIEL ROTH



REF. BRE 56S CHS

-  Acero
-  Automático
-  47 mm

PRECIO 
\$7,000





OBARRIO

OCTO FINISSIMO



REF. BGO40C

-  Acero
-  Automático
-  40 mm

PRECIO 
\$12,500



OBARRIO



CAJA



PAPELES

MOP LADY

"MADRE PERLA"



BBL P37 SG

-  Acero/Oro Rosa
-  37 mm
-  Automático

PRECIO 
\$7,000



OBARRIO





PAPELES

OCTO FINISSIMO



104190



-  Oro Rosa
-  40 mm
-  Automático

PRECIO 
\$32,600



OBARRIO

SOTIRIO

-  Oro Rosa
-  42 mm
-  Automático

PRECIO 
\$13,500



REF. 101705

B.ZERO1



-  Acero
-  35 mm
-  Quartz

PRECIO 
\$1,800



REF. BZ35BHDSGL/2

DANIEL ROTH



-  Acero
-  28.6 mm
-  Automático

PRECIO 
\$900



REF. BRE 56S CHS

RETTANGOLO



-  Acero
-  38.4 mm
-  Quartz

PRECIO 
\$1,800



REF. RT39S

DIAGONO



-  ACERO
-  AUTOMÁTICO
-  40 MM

PRECIO 
\$2,500



REF. DG 40 SV

DIAGONO



-  ACERO
-  38 MM
-  Automático

PRECIO 
\$3,500



REF. BB 38 SS CH

DIAGONO GMT

-  Oro Rosa
-  40 mm
-  Automático

PRECIO 
\$14,500





OBARRIO



REF. DGP40C6GLDGMT

ASSIOMA

-  Acero
-  48 mm
-  Automático

PRECIO 
\$4,000



OBARRIO



REF. AA 48 S.CH

BVLGARI LADY

-  Acero/Diamante
-  33 mm
-  Automático

PRECIO 
\$3,500



OBARRIO



CAJA



REF. BBL 33WSLC4

BVLGARI

-  Acero
-  23 mm
-  Quartz

PRECIO 
\$1,000



OBARRIO





PAPELECAJA



REF. BB23SS

RETTANGOLO

-  Oro Amarillo
-  25 X 45 mm
-  Automático

PRECIO 
\$7,850





OBARRIO



REF. RT 45 G

DIAGONO

-  Titanio
-  38 mm
-  Automático

PRECIO 
\$2,500



OBARRIO



REF. TI 38 R



Cartier

Prestigiosa maison de lujo reconocida por su herencia histórica, excelencia artesanal y enfoque artístico en la alta relojería.

A lo largo de su trayectoria, Cartier ha sabido fusionar innovación técnica con una profunda sensibilidad estética, dando vida a piezas que trascienden el tiempo. Hoy, la marca representa elegancia, sofisticación y un legado de creatividad que continúa influyendo en la relojería contemporánea.

AARON  JOYEROS

Cartier

PANTHERE VENDOME

"18K"

 Oro Amarillo

 22 mm

 Quartz

PRECIO 
\$9,650



AARON  JOYEROS

PANTHERE	SANTOS	TANK	ROADSTER	BALLON BLEU	PASHA
RONDE	CLÉ	CALIBRE			

PANTHERE COUGAR



 Oro Amarillo

 33 mm

 Quartz

PRECIO
\$18,650



OBARRIO

REF. 887904



Cartier



Oro



39.8 mm



Automático

PRECIO



\$35,000



OBARRIO



CAJA

AARON  JOYEROS

PANTHERE	SANTOS	TANK	ROADSTER	BALLON BLEU	PASHA
RONDE	CLÉ	CALIBRE			

SANTOS GALBBÉ



-  Acero
-  29 mm
-  Quartz

PRECIO 
\$5,500



REF. 1564

SANTOS XL

-  Acero
-  39.8 mm
-  Automático



PRECIO 
\$6,500



REF. 4072



SANTOS RONDÉ

-  Acero / Oro
-  33 mm
-  Automático

PRECIO 
\$5,000



REF. 1910

SANTOS GALBBÉ

-  Acero
-  29 mm
-  Quartz



PRECIO 
\$5,200



REF. 1564



SANTOS GALBBÉ

-  Acero / Oro
-  29 mm
-  Automático



PRECIO 
\$6,000



REF. 1172961

PANTHERE	SANTOS	TANK	ROADSTER	BALLON BLEU	PASHA
RONDE	CLÉ	CALIBRE			

TANK SOLO XL



-  Acero
-  31 mm
-  Automático

PRECIO 
\$4,500



REF. 3800

TANK ANGLAISE



-  Oro Rosa
-  47 X 35.2 mm
-  Automático

PRECIO 
\$35,520



REF. W531002

TANK AMERICANO



-  Oro Blanco
-  41 mm
-  Automático

PRECIO 
\$15,000



REF. 1726

TANK



-  Oro Amarillo
-  28 X 36 mm
-  Automático

PRECIO 
\$6,650



REF. 1830

TANK

-  Acero / Oro
-  25 mm
-  Automático



PRECIO 
\$5,500



REF. 2619

PANTHERE	SANTOS	TANK	ROADSTER	BALLON BLEU	PASHA
RONDE	CLÉ	CALIBRE			

ROADSTER

-  Oro 18 K
-  38 x 43 mm
-  Automático

PRECIO 
\$20,650





OBARRIO



REF. 2619

ROADSTER

"18 QUILATES"

-  Oro Amarillo
-  47.6 x 42.8 mm
-  Automático

PRECIO 
\$20,850





OBARRIO



REF. 2619

ROADSTER

"18 QUILATES"

-  Oro Amarillo
-  44 x 37 mm
-  Automático

PRECIO 
\$14,500





OBARRIO



REF. 2524

ROADSTER TORTUE PERPETUAL

-  Oro Rosa
-  42.5 34 mm
-  Automático

PRECIO 
\$30,000





OBARRIO



REF. 2666

ROADSTER

-  Oro Amarillo
-  47.6 mm
-  Automático

PRECIO 
\$38,000



OBARRIO



REF. 2619

Cartier



Acero



44 mm



Automático

PRECIO



\$6,500



OBARRIO

REF



3109

BALFOUR

AARON  JOYEROS

PANTHERE	SANTOS	TANK	ROADSTER	BALLON BLEU	PASHA
RONDE	CLÉ	CALIBRE			

BALLON BLEU



-  Oro Blanco
-  36 mm
-  Automático

PRECIO 
\$9,000



REF. 3004

BALLON BLEU



-  Acero
-  42 mm
-  Automático

PRECIO 
\$5,000



REF. 3765

BALLON BLEU



-  Oro Rosa
-  42 mm
-  Automático

PRECIO 
\$13,800



REF. 2999

BALLON BLEU

-  Oro Rosa
-  44 mm
-  Automático



PRECIO 
\$14,500



REF. 3107

BALLON BLEU

"BISEL AFTERMARKET"

-  Acero
-  40 mm
-  Automático

PRECIO 
\$6,800



REF. 3001

BALLON BLEU

-  Acero / Oro Rosa
-  42 mm
-  Automático



PRECIO 
\$9,000



REF. 3765

PANTHERE	SANTOS	TANK	ROADSTER	BALLON BLEU	PASHA
RONDE	CLÉ	CALIBRE			

BALLON BLEU

-  ACERO
-  42 mm
-  AUTOMÁTICO

PRECIO
\$5,500





OBARRIO



REF. WSBB0049

BALLON BLEU

-  ACERO
-  40 mm
-  AUTOMÁTICO

PRECIO
\$6,300



OBARRIO



CAJA



PAPELES



REF. WSBB0061



Cartier

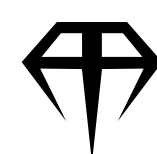

ÍNDICE

PANTHERE	SANTOS	TANK	ROADSTER	BALLON BLEU	PASHA
RONDE	CLÉ	CALIBRE			



PASHA

 ACERO

 38 mm

 AUTOMÁTICO

PRECIO 
\$4,500





OBARRIO



AARON  JOYEROS

PANTHERE	SANTOS	TANK	ROADSTER	BALLON BLEU	PASHA
RONDE	CLÉ	CALIBRE			

PASHA

-  Oro Blanco
-  32 mm
-  Automático



PRECIO 
\$8,500



OBARRIO

REF. 2528

PASHA

-  Oro
-  42 mm
-  Automático

PRECIO 
\$30,850



OBARRIO

REF. 2726

PASHA

-  Oro
-  38 mm
-  Quartz

PRECIO 
\$10,500



COSTA DEL ESTE

REF. 1987

PASHA

-  Acero
-  33 mm
-  Quartz

PRECIO 
\$3,200





OBARRIO

REF. W3140001



PANTHERE	SANTOS	TANK	ROADSTER	BALLON BLEU	PASHA
RONDE	CLÉ	CALIBRE			

RONDE SOLO XL

-  Acero
-  42 mm
-  Automático

PRECIO 
\$3,500



CDE



REF. 3802



PANTHERE	SANTOS	TANK	ROADSTER	BALLON BLEU	PASHA
RONDE	CLÉ	CALIBRE			

CLÉ



REF. 3850

- Acero
- 40 mm
- Automático

PRECIO \$4,200



OBARRIO

CLÉ



REF. 3847

- Oro Rosa
- 40 mm
- Automático

PRECIO \$25,000



OBARRIO



PANTHERE	SANTOS	TANK	ROADSTER	BALLON BLEU	PASHA
RONDE	CLÉ	CALIBRE			

CALIBRE

-  Acero / Oro Rosa
-  42 mm
-  Automático

PRECIO 
\$6,200



OBARRIO



REF. 3389

CALIBRE

-  Acero / Oro Rosa
-  42 mm
-  Automático

PRECIO 
\$7,000

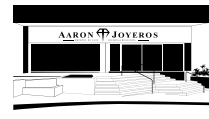



OBARRIO



REF. 3389



CALIBRE

-  Oro Rosa
-  42 mm
-  Automático

PRECIO 
\$37,000



OBARRIO



REF. 3300

CALIBRE

-  Acero / Oro Rosa
-  42 mm
-  Automático

PRECIO 
\$9,800

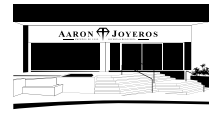



OBARRIO



REF. W7100042



CALIBRE

-  Acero / Oro
-  42 mm
-  Automático

PRECIO 
\$6,000



OBARRIO



CAJA



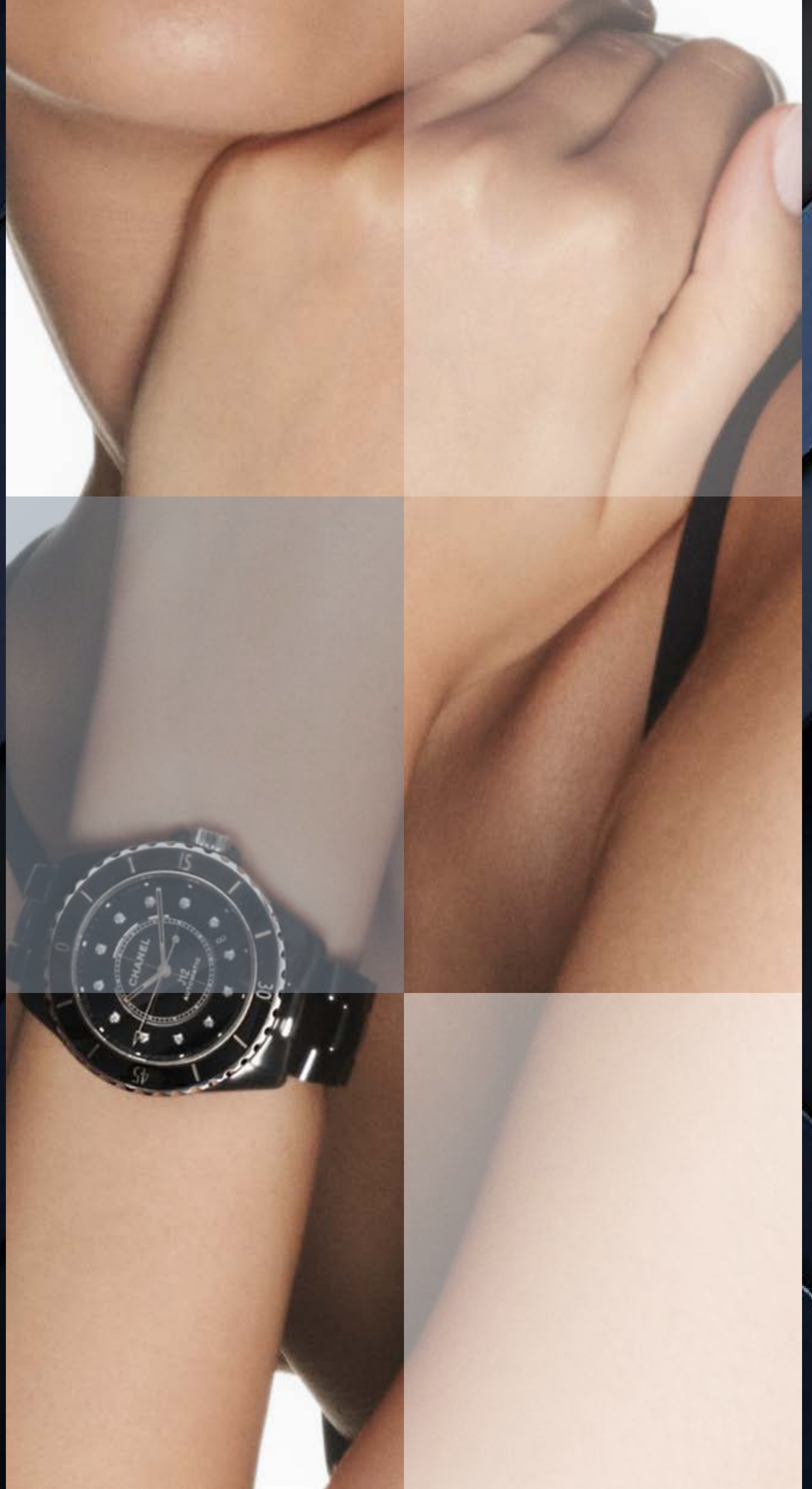

REF. W2CA0004



CHANEL

Chanel ha consolidado su presencia en la alta relojería mediante una propuesta que combina diseño vanguardista y precisión suiza. Sus colecciones, como J12 y Première, reflejan una estética distintiva que une elegancia contemporánea y carácter innovado. A lo largo de su evolución, la marca ha redefinido los códigos del reloj femenino y unisex, integrando materiales y formas poco convencionales. Chanel representa estilo, modernidad y una visión creativa única dentro del universo relojero.

J1

-  Cerámica
-  41 mm
-  Automático

PRECIO 
\$2,750



OBARRIO





PAPELES



REF. H2934

J12

-  Cerámica
-  39 mm
-  Automático

PRECIO 
\$2,750





OBARRIO



REF. H2934

J12 NOIRE

-  Cerámica
-  38 mm
-  Automático

PRECIO 
\$2,600



OBARRIO



REF. H5702





CHAUMET

PARIS

Chaumet ha desarrollado una propuesta relojera que combina elegancia, refinamiento y savoir-faire parisino. Sus creaciones destacan por su diseño delicado y su atención al detalle, integrando la relojería con el arte joyero. A lo largo de su trayectoria, la marca ha sabido expresar sofisticación a través de piezas que priorizan la estética sin perder precisión. Chaumet representa distinción, feminidad y tradición dentro del universo de la alta relojería.

KHESIS

 Acero/Nácar/Diamantes

 21 mm

 Quartz

PRECIO 

\$2,000





OBARRIO



REF. 40 38 44

KHESIS

 Acero/Diamantes

 17.5 x 28 mm

 Quartz

PRECIO 

\$1,800



OBARRIO



REF. 1.2330_PK

CLASS ONE CHRONO

 Acero

 40 mm

 Quartz

PRECIO 

\$1,800



OBARRIO



REF. 625B

STYLE

 Acero/Diamantes

 19 x 23 mm

 Quartz

PRECIO 

\$500



OBARRIO



REF. 35 34 13

MONTRE CHAUMET CHRONOGRAPHE

 Acero

 40 mm

 Automático

PRECIO 

\$3,600



OBARRIO



REF. 0000



Chopard

GENÈVE

Chopard es una reconocida casa suiza que combina alta relojería y joyería con un enfoque en la elegancia, la innovación y la artesanía. Sus creaciones destacan por la atención al detalle y el uso de materiales de alta calidad.

A lo largo de su trayectoria, la marca ha desarrollado colecciones icónicas que equilibran técnica y estética, consolidando su presencia en el mundo del lujo. Chopard representa refinamiento, creatividad y excelencia dentro del universo relojero.

Chopard

GENÈVE



Oro



44 mm



Automático

PRECIO



\$19,000

REF. 61276-5001



OBARRIO

MILLE MIGLIA



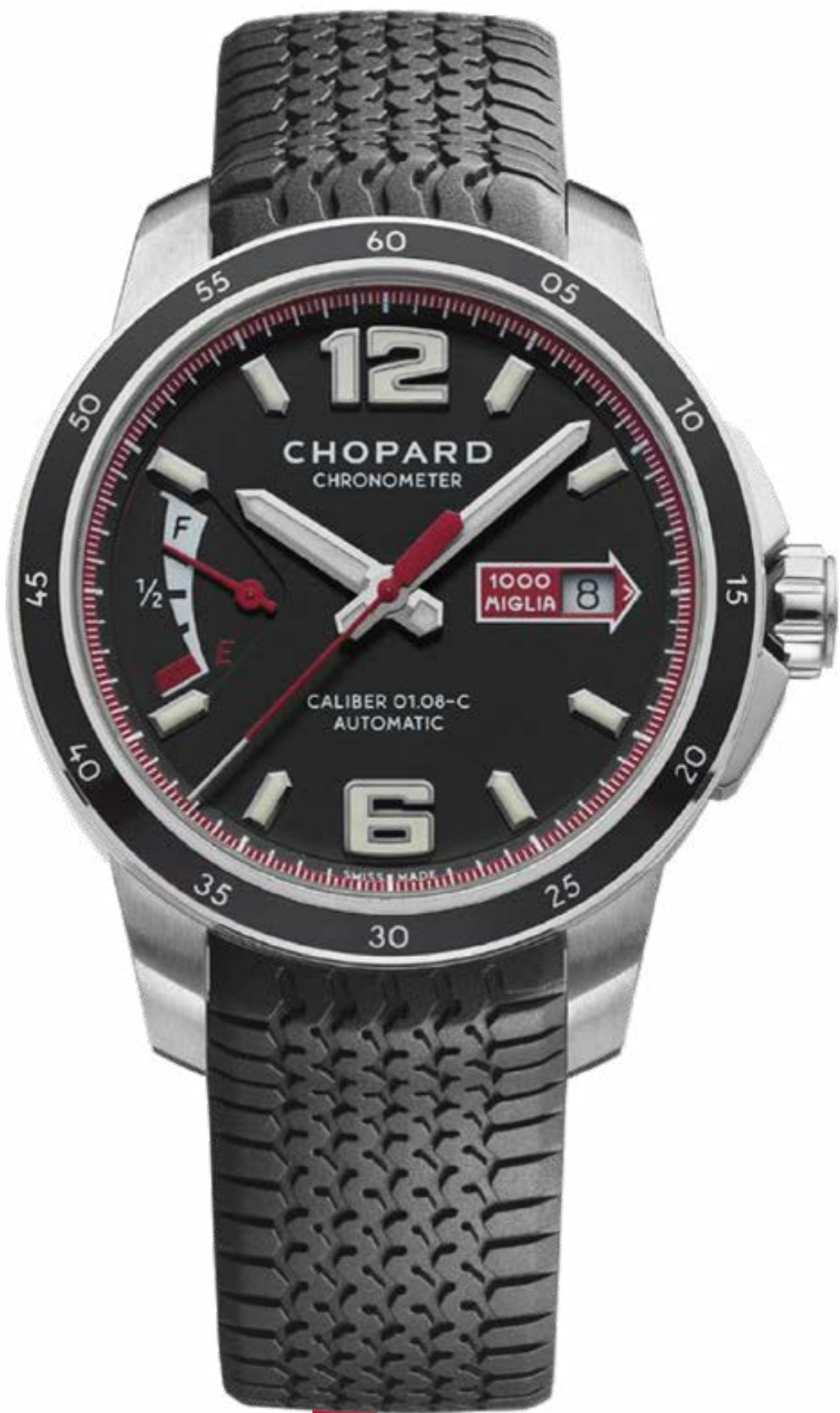

Chopard
GENÈVE

MILLE MIGLIA GTS





CAJAOBARRIO



PAPELES



POWER CONTROL

-  ACERO
-  43 mm
-  AUTOMÁTICO

PRECIO 
\$4,800

REF.



Chopard
GENÈVE

HAPPY DIAMOND

ORO/DIAMANTES

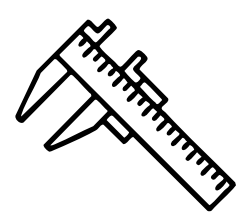

25 mm

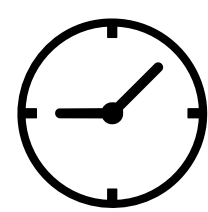

QUARTZ

PRECIO 

\$4,800

REF.

20/5605





OBARRIO



CAJA

GRAN TURISMO
XL

-  Acero
-  44 mm
-  Automático

PRECIO 
\$4,500





CDE



REF. 8997

SUPERFAST

-  Acero
-  44 mm
-  Automático

PRECIO 
\$5,500





OBARRIO



REF. 8542

GRAN TURISMO
XL

-  Acero
-  44 mm
-  Automático

PRECIO 
\$3,500





OBARRIO



REF. 8997

GRAND PRIX
DE MÓNACO

-  Acero
-  42.5 mm
-  Automático

PRECIO 
\$3,800





CDE



REF. 168992-3031

MIGLIA
CHRONOGRAPH

-  Oro
-  39 mm
-  Automático

PRECIO 
\$16,100



OBARRIO



CAJA





PAPELES



REF. 1274

HAPPY BEACH

-  Oro Rosa
-  42 mm
-  Quartz

PRECIO 
16,000



OBARRIO



REF. 283581-5011

IMPERIALE
CHRONO

- Acero
- Automático
- 38 mm

PRECIO 
\$2,500



REF. 8219

MILLE
MIGLIA

- Acero
- Automático
- 38 mm

PRECIO 
\$5,000



REF. 8588

IMPERIALE
CHRONO

- Acero
- 37 mm
- Automático

PRECIO 
\$3,000



REF. 8219

IMPERIALE
CHRONO

- Acero
- 40 mm
- Automático

PRECIO 
\$5,500



REF. 8549

HAPPY SPORT

- Acero
- 38 mm
- Quartz

PRECIO 
\$4,800



REF. 8347

CHOPARD
CHOPARD LUNA D'ORO

- Oro Amarillo
- 34 mm
- Quartz

PRECIO 
\$3,875



REF. 1086

HAPPY SPORT

- Acero / Oro Rosa
- 36 mm
- Quartz

PRECIO \$
\$7,000



OBARRIO



REF. 8475

HAPPY SPORT

- Acero
- 36 mm
- Quartz

PRECIO \$
\$4,500



OBARRIO



CAJA



PAPELES



REF. 8475

HAPPY SPORT

- Acero
- 42 mm
- Quartz

PRECIO \$
\$4,000



OBARRIO



REF. 288525-3002

HAPPY BEACH DIAMOND BLUE

- Acero
- 38 mm
- Quartz

PRECIO \$
\$3,200



OBARRIO



REF. 8542

HAPPY SPORT

- Acero
- 38 mm
- Quartz

PRECIO \$
\$2,000



OBARRIO



REF. 8347

HAPPY SPORT

- Acero
- 42 mm
- Quartz

PRECIO \$
\$4,500



OBARRIO





REF. 288499-3008

GRAN TURISMO
XL

- Acero
- 44 mm
- Automático

PRECIO 
\$3,500

-  OBARRIO
-  CAJA
-  PAPELES



REF. 8997

MILLE MIGLIA
ALFA ROMEO

"EDICIÓN LIMITADA"

- Acero
- 42 mm
- Automático

PRECIO 
\$2,400

-  OBARRIO



REF. 8954

MILLE MIGLIA
GRAN TURISMO

- Acero
- 44 mm
- Automático

PRECIO 
\$3,800

-  OBARRIO



REF. 168997

MILLE MIGLIA
GRAN TURISMO

- Oro Rosa
- 45 mm
- Automático

PRECIO 
\$22,050

-  OBARRIO
-  CAJA
-  PAPELES



REF. 161264

MIGLIA

- Acero
- 40 mm
- Automático

PRECIO 
\$2,600

-  OBARRIO





REF. 8955

MILLE MIGLIA
RACE EDITION

- ACERO
- 44 mm
- AUTOMÁTICO

PRECIO
\$5,500

-  OBARRIO
-  CAJA
-  PAPELES



REF. 168571-3004



CONCORD

Concord es una casa relojera suiza reconocida por su enfoque en la innovación y el diseño contemporáneo dentro del segmento de lujo. Sus creaciones se distinguen por líneas modernas y una marcada identidad estética.

A lo largo de su historia, la marca ha explorado conceptos audaces que rompen con lo tradicional. Concord representa modernidad y evolución en el diseño relojero.



CONCORD

CONCORD MARINER

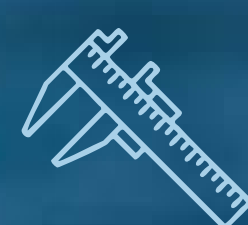

38 mm



AUTOMÁTICO

ACERO
PRECIO:

PRECIO 

\$950



OBARRIO

REF.

14H71891



CORUM



Concord es una casa relojera suiza reconocida por su enfoque en la innovación y el diseño contemporáneo dentro del segmento de lujo. Sus creaciones se distinguen por líneas modernas y una marcada identidad estética.

A lo largo de su historia, la marca ha explorado conceptos audaces que rompen con lo tradicional. Concord representa modernidad y evolución en el diseño relojero.

AARON  JOYEROS

ADMIRAL'S CUP



-  Oro Rosa
-  44 mm
-  Automático

PRECIO 
\$12,000





CDE

REF. 753 812

VINTAGE



-  Oro / Cuero
-  24 mm
-  Quartz

PRECIO 
\$4,000



OBARRIO





PAPELES

REF. 0000

ADMIRAL'S CUP

"BISEL/CORONA ORO ROSA"



-  Acero / Oro
-  48 mm
-  Automático

PRECIO 
\$5,500





OBARRIO

REF. A690/04312

ADMIRAL'S CUP



-  Oro Rosa
-  Automático
-  48 mm

PRECIO 
\$12,000



OBARRIO





CAJA

REF. 277.931.91/0371 AG32

ADMIRAL'S CUP



-  Acero
-  41 mm
-  Automático

PRECIO 
\$2,500



OBARRIO

REF. 82.833.20

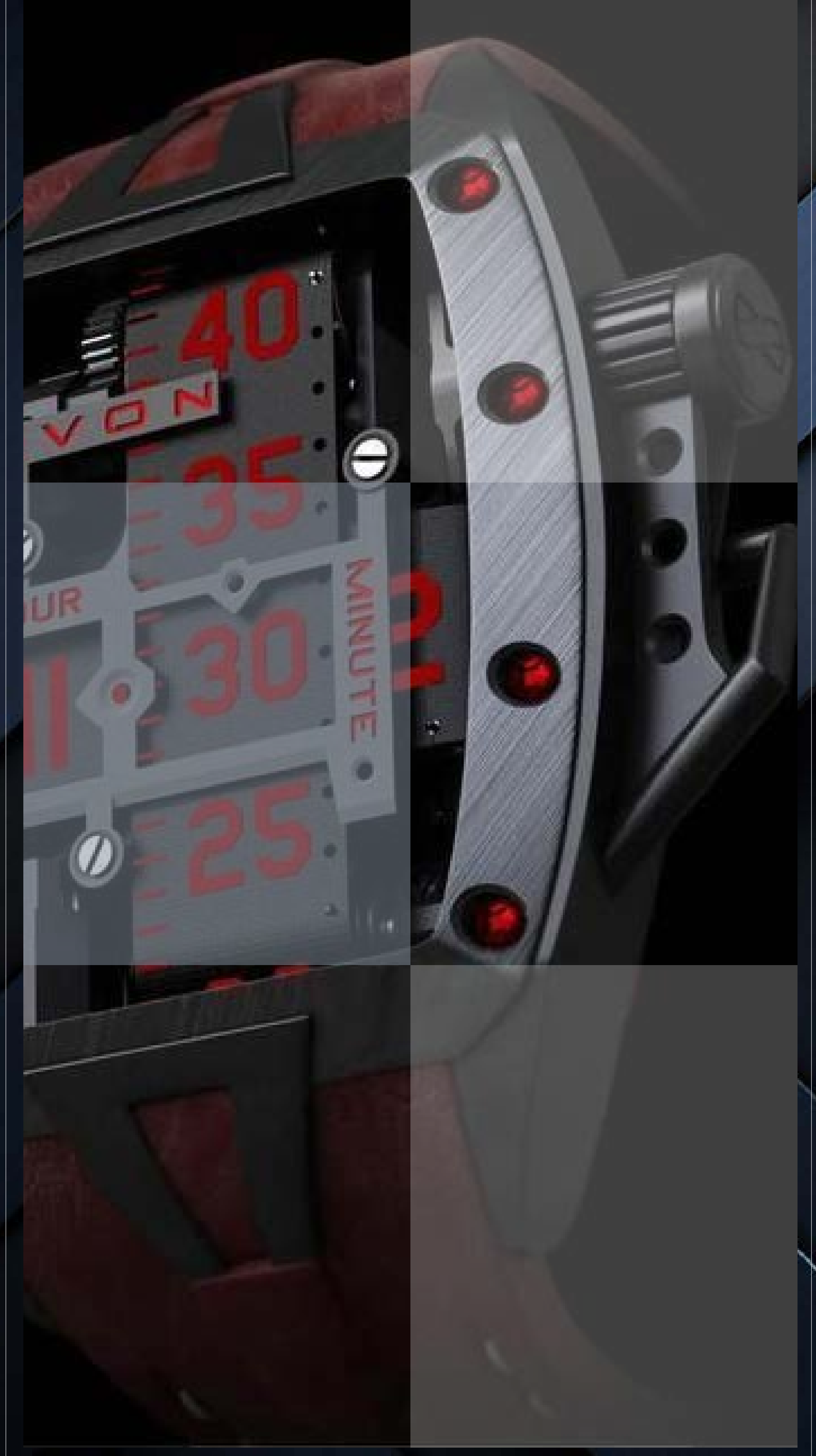

DEVON

Devon ha fusionado ingeniería de alto nivel con una estética disruptiva. Devon representa vanguardia, innovación y una visión tecnológica del tiempo. Es una innovadora firma estadounidense que ha redefinido la relojería mediante el uso de tecnología avanzada y diseño futurista. Sus relojes destacan por sistemas de correas motorizadas y mecanismos electrónicos únicos, alejándose de la relojería tradicional.

AARON  JOYEROS

TREAD 2 REDRUM



Acero



44.2 x 41.7 mm

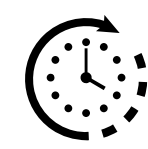

Quartz

PRECIO 

\$6,000



OBARRIO



CAJA

REF.

M0064



DUMOREAU

Devon ha fusionado ingeniería de alto nivel con una estética disruptiva. Devon representa vanguardia, innovación y una visión tecnológica del tiempo. Es una innovadora firma estadounidense que ha redefinido la relojería mediante el uso de tecnología avanzada y diseño futurista. Sus relojes destacan por sistemas de correas motorizadas y mecanismos electrónicos únicos, alejándose de la relojería tradicional.

DUMOREAU



 Acero

 38.6 mm

 Automático

PRECIO 

\$700



OBARRIO

REF. DM-01



⌘
EBEL

La casa Ebel se ha caracterizado por crear piezas que priorizan el detalle y la comodidad en la muñeca. Ebel representa sofisticación discreta y tradición dentro de la relojería suiza. Conocida por su estilo elegante y equilibrado, donde el diseño y la precisión se combinan de forma armoniosa. Sus relojes destacan por líneas refinadas y una estética atemporal que ha definido su identidad a lo largo de los años.

AARON  JOYEROS

SPORT WAVE



ACERO

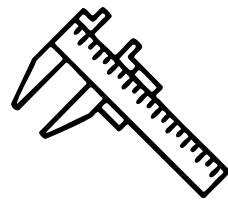

28 mm

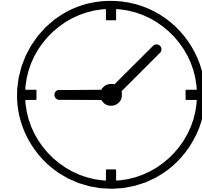

QUARTZ

PRECIO 
\$750

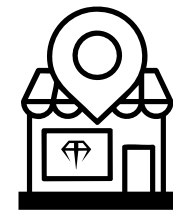

OBARRIO



CAJA

REF.

E9955K41

SPORT WAVE



REF. E9087622

- Acero
- 36 mm
- Quartz

PRECIO \$900



OBARRIO

CLASSIC WAVE



REF. 888901

- Oro Amarillo
- 23 mm
- Quartz

PRECIO \$13,300



CDE

DRESSWAVE



REF. E6157912

- Acero y Oro
- 24 mm
- Quartz

PRECIO \$700



OBARRIO

SPORT WAVE



REF. 12607794

- Acero
- 26 mm
- Quartz

PRECIO \$1,200



OBARRIO

DRESS WAVE



REF. 98501259

- Acero
- 35 mm
- Quartz

PRECIO \$750



OBARRIO



PAPELES

SPORT WAVE CLASSIC



REF. E 6187631

- Acero / Oro Ama
- 27 mm
- Quartz

PRECIO \$800



OBARRIO

SPORT WAVE

-  Acero
-  36 mm
-  Quartz

PRECIO 
\$900



OBARRIO



REF. E6187631

EBEL

-  Acero / Oro
-  34 mm
-  Quartz

PRECIO 
\$1,500



OBARRIO



REF. W522084

LADY SPORT

-  Acero / Oro
-  27 mm
-  Quartz

PRECIO 
\$900



OBARRIO





CAJA



REF. EBL-010

LADY

-  Acero / Oro
-  23 mm
-  Automático

PRECIO 
\$1,300



OBARRIO



REF. 1057902

SPORTWAVE

-  Acero
-  36 mm
-  Quartz

PRECIO 
\$400



OBARRIO



REF. E6120531

E-TYPE

-  Acero
-  36 mm
-  Quartz

PRECIO 
\$1,000



OBARRIO



REF. E9187C41



EBERHARD & Co

Eberhard & Co. es una prestigiosa casa relojera suiza fundada en 1887, reconocida por su tradición en relojes deportivos y cronógrafos de alta precisión.

La marca se ha distinguido por combinar elegancia clásica, innovación mecánica y una fuerte identidad técnica. Sus colecciones destacan por diseños refinados, movimientos de calidad y una atención minuciosa a los detalles.

AARON  JOYEROS

8 DÍAS



REF. 20017

-  Oro
-  39 mm
-  Cuerda Manual

PRECIO 
\$7,000

-  OBARRIO
-  CAJA







EDOX

Reconocida por su enfoque en la precisión y la resistencia, especialmente en relojes deportivos y de buceo. Sus creaciones combinan ingeniería robusta con un diseño funcional, orientado al rendimiento en condiciones exigentes.

A lo largo de su trayectoria, la marca ha desarrollado modelos fiables y técnicos, consolidando su reputación en la relojería deportiva. Edox representa durabilidad, exactitud y espíritu aventurero.

AARON  JOYEROS

EDOX

 Acero

 46 mm

 Quartz

PRECIO 

\$900



OBARRIO



CAJA



REF. 10021 3 NIN



F
FENDI

Fendi combina la elegancia italiana con la precisión suiza, creando relojes que destacan por su diseño sofisticado y moderno. Sus piezas priorizan la estética, los detalles de moda y materiales de alta calidad, posicionándose como accesorios de lujo más que relojes técnicos.

AARON  JOYEROS

RUN AWAY

-  Acero
-  36 mm
-  Quartz

PRECIO 

\$500



OBARRIO



REF. FOW807A5UGF0QA1

RUN AWAY

-  Acero
-  36 mm
-  Quartz

PRECIO 

\$340



OBARRIO



REF. F136031573T01



GP GIRARD-PERREGAUX

Girard-Perregaux es una de las manufacturas relojeras suizas más antiguas, con orígenes que se remontan a 1791. Reconocida por producir sus propios movimientos y por su enfoque en la Alta Relojería, la marca combina innovación técnica, diseño refinado y una rica herencia histórica. Entre sus mayores iconos se encuentra el legendario Tourbillon con Tres Puentes de Oro, una obra maestra que se convirtió en símbolo de la casa.

VINTAGE

1945

-  Oro Rosa
-  23.5 mm
-  Cuerda Manual

PRECIO 
\$4,500





OBARRIO



REF. 25900-52-161-BAGA

GYROMATIC

-  Oro
-  34 mm
-  Automático

PRECIO 
\$3,500



OBARRIO



REF. 352





GRAHAM

//// //// //// LONDON

Distintiva firma relojera suiza conocida por su fuerte carácter técnico y diseño audaz. Sus relojes destacan por elementos únicos como el gatillo lateral del cronógrafo, inspirado en la instrumentación aeronáutica y militar.

A lo largo de su evolución, la marca ha mantenido un enfoque en la innovación y la funcionalidad, creando piezas con gran presencia y personalidad. Graham representa ingeniería, originalidad y espíritu deportivo en la relojería contemporánea.

AARON  JOYEROS

CHRONOFIGHTER
OVERSIZE SAHARA

- Acero
- 46 mm
- Automático



PRECIO 
\$3,000



REF. 2CCAU.B02A.T13N



CHRONOFIGHTER
OVERSIZE

- Acero
- 47 mm
- Automático



PRECIO 
\$3,000



REF. 20VDIVAZ.B02A.K10B



CHRONOFIGHTER
OVERSIZE

- Acero
- 47 mm
- Automático



PRECIO 
\$3,800



REF. OR-20VBV-1





GUCCI



Gucci es una influyente casa de lujo que ha extendido su creatividad al mundo de la relojería, destacándose por su enfoque en el diseño y la expresión estética. Sus relojes reflejan una identidad audaz y contemporánea, combinando moda, innovación y detalles distintivos.

A lo largo del tiempo, la marca ha desarrollado piezas que priorizan el estilo sin dejar de lado la calidad y la precisión. Gucci representa modernidad, tendencia y una visión creativa dentro del universo relojero.

AARON  JOYEROS

GUCCI



WATCHES

- Acero
- 38 mm
- Automático

PRECIO \$1,000



REF 136.2



OBARRIO

AARON JOYEROS



★
HAMILTON

Hamilton es una marca histórica de la relojería reconocida por combinar la precisión suiza con una fuerte herencia estadounidense, destacándose por su innovación técnica, diseños versátiles y espíritu aventurero. A lo largo de los años ha ganado prestigio en la aviación, el cine y el ámbito militar, creando relojes que equilibran funcionalidad, elegancia y rendimiento. Sus colecciones reflejan un estilo clásico con detalles contemporáneos, convirtiéndose en una referencia para quienes buscan tradición, calidad y carácter relojero.

AARON  JOYEROS

VENTURA

XXL BRIGHT DUNE



PAPELESCAJA



"Limited Edition"



- Acero
- 52 mm
- Quartz

PRECIO \$1,700





El Ventura XXL Bright Dune es una edición limitada inspirada en el reloj creado por Dune: Parte Dos, con una esfera azul luminosa que evoca los ojos de los Fremen. Su diseño futurista y detalles inspirados en la película lo convierten en una pieza imprescindible para coleccionistas y fanáticos de la saga.

REF. H24614330



D U N E

VALIANT AUTO



-  Acero
-  40 mm
-  Automático

PRECIO 
\$700

-  OBARRIO
-  CAJA
-  PAPELES

REF. H395150



HAMILTON

JAZZ MASTER



Acero



42 mm



Automático



CAJA

PRECIO



\$850

REF

H895450



AARON JOYEROS



OBARRIO



HARRY WINSTON

Harry Winston es una prestigiosa casa de lujo reconocida por su excelencia en alta joyería y su incursión en la alta relojería con piezas de gran sofisticación. Sus creaciones destacan por la integración de complicaciones técnicas y el uso excepcional de diamantes y gemas.

AARON  JOYEROS



HARRY WINSTON

PROXIMAMENTE



ORO ROSA

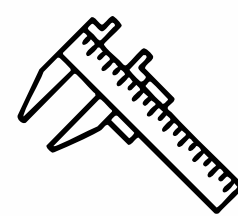

48 mm

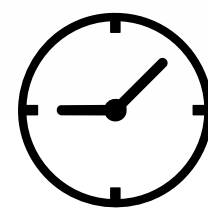

AUTOMÁTICO

PRECIO 
\$120,000

TOURBILLON GLISSIERE



REF. 50-MATRL

PRECIO RETAIL:
\$350,000

CON MANTENIMIENTO DE AGENCIA



OBARRIO



⌘ HUBLOT

Hublot es una innovadora manufactura suiza reconocida por su filosofía de "fusión", combinando materiales no convencionales como cerámica, carbono y caucho con la alta relojería tradicional. Sus diseños audaces y contemporáneos han redefinido el concepto de lujo deportivo.

A lo largo de su evolución, la marca ha destacado por su enfoque disruptivo y tecnológico, creando piezas de gran impacto visual y técnico. Hublot representa vanguardia, innovación y una nueva forma de entender la relojería de lujo.

AARON ⌘ JOYEROS

H HUBLLOT



KING POWER

UEFA EURO 2012

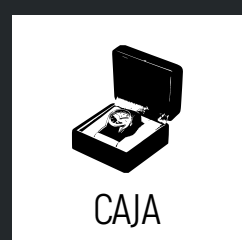

CAJA



OBARRIO



Acero



48 mm



Automático

PRECIO 
\$13,500



REF. 716.NM.1129.RX.EURO12

AARON  JOYEROS

H HUBLOT

KING POWER



OBARRIO

ORO ROSA



48 mm



AUTOMÁTICO

PRECIO 

\$15,000





REF. 01.OQ.0180.RX



AARON  JOYEROS

BIG BANG

-  Acero
-  44 mm
-  Automático

PRECIO 
\$7,500





OBARRIO



REF. 301.SX.130.RX

KING POWER ÚNICO

-  Titanio/Diamantes
-  48 mm
-  Automático

PRECIO 
\$20,000



OBARRIO





PAPELES



REF. 701.NX.0170.RX.1740

BIG BANG FERRARI

-  Titanio
-  45 mm
-  Automático

PRECIO 
\$15,500





OBARRIO



REF. 401.NQ.0123.VR

KING POWER SAINT BARTH

-  Cerámica
-  48 mm
-  Automático

PRECIO 
\$15,000





OBARRIO



REF. HUB4200

BIG BANG RED

-  Cerámica
-  44 mm
-  Automático

PRECIO 
\$9,500





CDE



REF. 301.CI.1130.GR.ABR10

BIG BANG

-  Carbono
-  45 mm
-  Automático

PRECIO 
\$14,000



OBARRIO



CAJA



PAPELES



REF. 411.YT.1110.NR.IT115

BIG BANG

Titanio/Diamantes

45 mm

Automático

PRECIO

\$12,500



OBARRIO



REF. 4j01.CX.0123.VR

BIG BANG

Cerámica

44 mm

Automático

PRECIO

\$9,000



OBARRIO



CAJA



PAPELES



REF. 301.CT.130.RX

BIG BANG KING POWER

Oro Rosa

48 mm

Automático

PRECIO

\$18,000



OBARRIO



CAJA



PAPELES



REF. 322.PX.100.RX

BIG BANG BI-RETROGRADE

"KING ORO"

Cerámica/Oro Rosa

45 mm

Automático

PRECIO

\$24,200



CDE



REF. 413.OM.1128.RX

KING POWER F1 ABU DHABI

"LIMITED EDITION"

Fibra de Carbón

48 mm

Automático

PRECIO

\$10,000



OBARRIO



CAJA



REF. 719.QM.1729.NR.FAD11

BIG BANG CHRONOGRAPH

Oro Rosa

44 mm

Automático

PRECIO

\$17,500



OBARRIO



REF. 301.PM.1780.RX

BIG BANG JEANS

- Acero
- 44 mm
- Automático



PRECIO
\$9,800



OBARRIO

REF. 301.SX.2710.NR.JEANS

BIG BANG

- Acero
- 44 mm
- Automático



PRECIO
\$8,500



OBARRIO

REF. 301.CI.2770.NR

MDN GENEVE

- Oro Amarillo
- 36 mm
- Quartz



PRECIO
\$6,500



OBARRIO



CAJA



PAPELES

REF. 1512.100.3

MDN TEDDY BEAR

- Acero
- 26 mm
- Quartz



PRECIO
\$2,000



OBARRIO



CAJA



PAPELES

REF. 1392.999.3

BIG BANG BLACK DIAL

- Cerámica
- 44 mm
- Automático



PRECIO
\$6,800



OBARRIO

REF. 301.CM.130.RX

SUPER B

- Oro Rosa
- 42 mm
- Automático



PRECIO
\$20,000



OBARRIO

REF. 1920.8

BIG BANG KING POWER

- Acero
- 44 mm
- Automático

PRECIO 
\$9,500



OBARRIO



REF. 701.CI.1123.GR

BIG BANG

- Acero
- 38 mm
- Quartz

PRECIO 
\$7,500



OBARRIO



REF. 361.SX.7170.LR.1204

BIG BANG KING POWER F1

- Fibra de Carbono
- 48 mm
- Automático

PRECIO 
\$11,000



OBARRIO



CAJA



PAPELES



REF. 703.QM.1129.HR.FIL11

BIG BANG KING POWER F1

- Oro Rosa
- 48 mm
- Automático

PRECIO 
\$21,000



OBARRIO



CAJA



PAPELES



REF. 703.OM.1138.NR.FM010

BIG BANG

- Oro Rosa/Titanio
- 45 mm
- Automático

PRECIO 
\$19.500



OBARRIO



CAJA



REF. 614.OX.1180.RX

BIG BANG

- Oro Rosa
- 41 mm
- Automático

PRECIO 
\$18,000



OBARRIO





REF. 341.PT.5010.LR.1104

CLASSIC FUSION

- Acero
- 42 mm
- Automático

PRECIO 
\$6,000

-  OBARRIO
-  CAJA
-  PAPELES



REF. 542.NX.1270.RX

CLASSIC FUSION

- Titanio
- 45 mm
- Automático

PRECIO 
\$5,700

-  OBARRIO



REF. 511.NX.1170.LR

BIG BANG

- Acero
- 44 mm
- Automático

PRECIO 
\$7,500

-  OBARRIO



REF. 301SX.1170.RX

CLASSIC FUSION

- Titanio
- 42 mm
- Automático

PRECIO 
\$6,000

-  OBARRIO



REF. 542.NX.8970.RX





IWC

SCHAFFHAUSEN

IWC Schaffhausen es una reconocida manufactura suiza que destaca por su ingeniería de precisión y diseño funcional con influencia técnica. Sus relojes, especialmente en líneas como Pilot's Watches y Portugieser, reflejan un enfoque claro en la legibilidad, la robustez y la elegancia.

A lo largo de su historia, la marca ha combinado tradición relojera con innovación mecánica, consolidándose como referente en relojería técnica. IWC representa precisión, fiabilidad y sofisticación en la alta relojería.

INGENIEUR

-  Cerámica
-  46 mm
-  Automático

PRECIO 
\$5,500





OBARRIO



REF. IW322504

AQUATIMER

-  Acero
-  46.6 mm
-  Automático

PRECIO 
\$4,200





OBARRIO



REF. IW376709

AVIADOR

-  Acero
-  46.2 mm
-  Automático

PRECIO 
\$7,000



OBARRIO



CAJA





PAPELES



REF. IW50100

PORTUGIESER YACHT CLUB

-  Acero
-  44 mm
-  Automático

PRECIO 
\$7,800





OBARRIO



REF. W390503

AQUATIMER EDICIÓN GALÁPAGOS

"CHARLES DARWING"

-  Acero
-  44 mm
-  Automático

PRECIO 
\$4,000





OBARRIO



REF. W376705

AQUATIMER

-  Oro Rosa
-  44 mm
-  Automático

PRECIO 
\$20,000



OBARRIO



CAJA



PAPELES



REF. W376905





JAEGER-LECOULTRE

Jaeger-LeCoultre es una histórica manufactura suiza reconocida por su excelencia técnica, innovación y dominio en la creación de calibres propios. Sus relojes, como el icónico Reverso, reflejan una perfecta fusión entre ingeniería y elegancia atemporal.

A lo largo de su trayectoria, la marca ha desarrollado numerosas complicaciones y avances en la relojería. Jaeger-LeCoultre representa tradición, precisión y maestría dentro de la alta relojería suiza.

AARON  JOYEROS

**MASTER
CALENDAR**

-  Oro Rosa
-  39 mm
-  Automático

PRECIO 
\$14,000





OBARRIO



REF. 176.2.12.S

RENDEZ-VOUS

-  Acero
-  34 mm
-  Automático

PRECIO 
\$7,000



OBARRIO



REF. 344.8.37







LONGINES

Longines es una histórica casa suiza destacada por su elegancia, precisión y tradición relojera. Sus diseños reflejan un estilo clásico y atemporal que ha perdurado a lo largo del tiempo.

Longines representa fiabilidad, refinamiento y herencia dentro de la relojería suiza.

AARON  JOYEROS

CONQUEST

-  Acero
-  44.5 mm
-  Automático

PRECIO 
\$2,000





OBARRIO



REF. L3.697.4

VINTAGE

-  Oro Amarillo
-  24 mm
-  Automático

PRECIO 
\$9,400



CDE



CAJA





PAPELES



REF. 26310R.00

LEGEND DIVER

-  Acero
-  42 mm
-  Automático

PRECIO 
\$2,200





OBARRIO



REF. L3.774.4.50.9

EVIDENZA

-  Acero
-  38.75 mm
-  Automático

PRECIO 
\$1,500





OBARRIO



REF. L2.642.4.51.6

SAINT-IMIER

-  Oro
-  36.8 mm
-  Automático

PRECIO 
\$5,600





OBARRIO



REF. L.989.2

MASTER COLLECTION

"Pulso Aftermarket"

-  Acero
-  42 mm
-  Automático

PRECIO 
\$1,600





OBARRIO





REF. 26664783

HERITAGE AVIGATION BIG EYE



-  Titanio
-  41 mm
-  Automático



PRECIO 
\$3,200

-  OBARRIO
-  CAJA
-  PAPELES

REF. L2.816.1

SPIRIT



-  Acero
-  37 mm
-  Automático



PRECIO 
\$2,400

-  OBARRIO
-  CAJA
-  PAPELES

REF. L3.410.4.93.6

MASTER COLLECTION MOONPHASE CHRONOGRAPH



-  ACERO
-  40 mm
-  AUTOMÁTICO

PRECIO
\$2,000

-  OBARRIO

REF. L2.673.4.78.3





**MONT
BLANC** 

Montblanc es una distinguida casa de lujo que ha incursionado en la alta relojería combinando precisión suiza con diseño elegante y contemporáneo. Sus relojes reflejan un equilibrio entre tradición, innovación y estética refinada.

Montblanc representa sofisticación, funcionalidad y una visión moderna dentro del universo relojero.

AARON  **JOYEROS**

MONT
BLANC

TIMEWALKER



ACERO



43 mm



AUTOMÁTICO

PRECIO



\$2,200



REF.

7069



OBARRIO

AARON  JOYEROS

PRINCESS GRACE DE MÓNACO

- Acero
- 34 mm
- Quartz

PRECIO \$
\$1,500

- OBARRIO
- CAJA



REF. 106884

TIMEWALKER

- Acero
- 39 mm
- Automático

PRECIO \$
\$1,800

- OBARRIO
- CAJA
- PAPELES



REF. 7308

MONTBLANC

- Acero
- 41 mm
- Automático

PRECIO \$
\$3,500

- OBARRIO



REF. 7383

TIMEWALKER

- Acero
- 42 mm
- Automático

PRECIO \$
\$1,200

- CDE



REF. 7070

TIMEWALKER

- Acero
- 42 mm
- Automático

PRECIO \$
\$1,500

- OBARRIO
- CAJA



REF. 4810

STAR

- Acero
- 40 mm
- Quartz



PRECIO \$
\$1,400

- OBARRIO



REF. MB104182

TIMEWALKER OROLOGIO

-  Acero
-  43 mm
-  Automático

PRECIO 
\$1,600





OBARRIO



REF. 0969

MEINSTERSTUCK

-  Acero
-  42 mm
-  Automático

PRECIO 
\$1,500



OBARRIO





CAJA



REF. 7070

MEINSTERSTUCK

-  Acero
-  43 mm
-  Automático

PRECIO 
\$2,000



OBARRIO



REF. 7141

STUCK

-  Acero
-  36 mm
-  Quartz

PRECIO 
\$1,200





OBARRIO



REF. 7038

TIMEWALKER GMT

-  Acero
-  42 mm
-  Automático

PRECIO 
\$2,000





OBARRIO



REF. 7081

STAR

-  Acero
-  42 mm
-  Automático

PRECIO 
\$2,500



OBARRIO



REF. 110642

MONTBLANC

- Acero
- 41 mm
- Automático

PRECIO 
\$1,500



OBARRIO



REF. 4810



MONTBLANC

1858

- Acero
- 42 mm
- Automático

PRECIO 
\$2,200



OBARRIO



CAJA



PAPELES



REF. 1858



SPORT

- Acero
- 41 mm
- Automático

PRECIO 
\$1,500



OBARRIO



REF. 7034





MAURICE LACROIX

Manufacture Horlogère Suisse

Maurice Lacroix es una casa suiza que destaca por su enfoque en el diseño contemporáneo y la innovación accesible dentro de la relojería. Sus creaciones combinan precisión, estética moderna y un fuerte carácter visual.

Maurice Lacroix representa creatividad, dinamismo y una propuesta actual en la relojería suiza.



ORO AMARILLO

 46 mm

 AUTOMÁTICO

PRECIO 
\$19,000

OBARRIO

MASTERPIECE

REF. MP7281





MASTERPIECE

ORO AMARILLO 18K



40 mm



AUTOMÁTICO

PRECIO 

\$17,000



OBARRIO

REF.

MP6388



Ω OMEGA

Omega es una prestigiosa marca suiza de relojería fundada en 1848, reconocida por su precisión, innovación y fuerte legado histórico. Es famosa por hitos como el Apollo 11 Moon Landing, donde su modelo Speedmaster fue el primer reloj en la Luna, y por ser cronómetro oficial de los Juegos Olímpicos.

Hoy, Omega representa lujo, tecnología avanzada y diseño icónico dentro de la alta relojería.

SEAMASTER

SPEEDMASTER

CONSTELLATION

DE VILLE

DYNAMIC



OBARRIO



Oro Amarillo



41 mm



Automático

PRECIO



\$33,300

REF. 2134.80.00

REF.

SEAMASTER



45.5 mm



AUTOMÁTICO



OBARRIO

SEAMASTER

PRECIO 
\$8,000

TITANIO

REF. 215.90.46.51.99.001



CAJA



PAPELES



SEAMASTER

SPEEDMASTER



CONSTELLATION

DE VILLE

DYNAMIC

SEAMASTER PLANET OCEAN

"PANAMA CANAL"

-  Acero
-  45.5 mm
-  Automático

PRECIO 
\$6,000





OBARRIO



REF. 232.30.46.21.01.005



SEAMASTER PLANET OCEAN

-  Cerámica
-  45.5 mm
-  Automático

PRECIO 
\$8,500





OBARRIO



REF. 215.92.22.01.004



SEAMASTER 300

-  Acero
-  45.5 mm
-  Automático

PRECIO 
\$5,800



OBARRIO



REF. 234.30.41.21.03.001



SEAMASTER SPEEDMASTER CONSTELLATION DE VILLE DYNAMIC

SEAMASTER



REF. 2551.80

- Acero
- 36 mm
- Automático

PRECIO \$2,500



OBARRIO

SEAMASTER PLANET OCEAN 600M



REF. 232.30.44.22.01.001

- Acero
- 43.5 mm
- Automático

PRECIO \$5,000



OBARRIO



CAJA



PAPELES

SEAMASTER



REF. 2561.80.00

- Acero
- 36 mm
- Quartz

PRECIO \$2,000



OBARRIO

SEAMASTER 300M



REF. 22228000

- Acero
- 36 mm
- Automático

PRECIO \$2,600



OBARRIO

SEAMASTER



REF. 2561.80.00

- Acero
- 36 mm
- Quartz

PRECIO \$2,000



OBARRIO

SEAMASTER



REF. 2561.80.00

- Acero
- 36 mm
- Quartz



PRECIO \$2,000



OBARRIO

SEAMASTER SPEEDMASTER CONSTELLATION DE VILLE DYNAMIC

SEAMASTER AQUA TERRA

-  Acero
-  43 mm
-  Automático

PRECIO 
\$4,500





CDE



REF. 231.10.44.50.02.001

SEAMASTER

-  Oro
-  34 mm
-  Automático

PRECIO 
\$3,500



OBARRIO





CAJA



REF. 166.0217

SEAMASTER

-  ACERO
-  mm
-  AUTOMÁTICO

PRECIO
\$1,800



OBARRIO



REF. 2561.80.00

SEAMASTER

SPEEDMASTER

CONSTELLATION

DE VILLE

DYNAMIC

SPEEDMASTER MOONPHASE

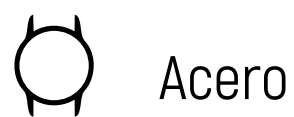

Acero



44.2 mm



Automático

PRECIO

\$8,500



OBARRIO



REF. 304.33.44.52.03.001

SPEEDMASTER



Cerámica/Nato



42.2 mm



Automático

PRECIO

\$8,500



OBARRIO



REF. 311.92.44.51.01.007



SEAMASTER	SPEEDMASTER	CONSTELLATION	DE VILLE	DYNAMIC
-----------	-------------	---------------	----------	---------

CONSTELLATION

 Acero / Oro Rosa

 35 mm

 Automático

PRECIO 

\$6,500



OBARRIO



CAJA



PAPELES



REF. 23.20.35.20.63.001

CONSTELLATION BICOLOR

 Acero y Oro

 38 mm

 Automático

PRECIO 

\$8,000



OBARRIO



CAJA



PAPELES



REF. 123.20.38.21.03.001

CONSTELLATION BICOLOR

 Acero y Oro

 34 mm

 Quartz

PRECIO 

\$2,500



OBARRIO



REF. 55296372

CONSTELLATION MOTHER OF PEARL

 Acero y Oro

 24 mm

 Quartz

PRECIO 

\$1,800



CDE



REF. 795.1203

CONSTELLATION

 Acero / Oro

 29 mm

 Automático

PRECIO 

\$9,800



OBARRIO



REF. 31.20.29.20.05.002

CONSTELLATION

 Acero / Oro

 35.5 mm

 Quartz

PRECIO 

\$2,800



OBARRIO



REF. 302.30.00

SEAMASTER SPEEDMASTER CONSTELLATION DE VILLE DYNAMIC

CONSTELLATION QUADRA

"DIAL MADRE PERLA"

-  Acero
-  24 X 19.3 mm
-  Quartz

PRECIO 
\$1,400



OBARRIO



REF. 1521.7100

CONSTELLATION

-  Acero
-  27 mm
-  Quartz

PRECIO 
\$2,500



OBARRIO



CAJA





PAPELES



REF. 123.10.27.60.02.002

CONSTELLATION QUADRA DIAMOND

-  Acero / Diamante
-  19 mm
-  Quartz

PRECIO 
\$2,000



OBARRIO



REF. 1528.76.00

CONSTELLATION

-  Acero / Oro
-  35 mm
-  Quartz

PRECIO 
\$2,500



OBARRIO



PAPELES



REF. 1212.30.00

CONSTELLATION QUADRA DIAMOND

-  Acero
-  19 mm
-  Quartz

PRECIO 
\$1,200





OBARRIO



REF. 1528.76.00

CONSTELLATION

-  Oro Amarillo
-  35 mm
-  Automático

PRECIO 
\$4,000



OBARRIO



REF. 2853

SEAMASTER SPEEDMASTER CONSTELLATION DE VILLE DYNAMIC

DEVILLE VINTAGE

"BISEL DE DIAMANTES"

-  Oro Blanco
-  25.4 mm
-  Quartz

PRECIO 
\$8,000





OBARRIO



REF. VINTAGE

DE VILLE

-  Acero
-  41 mm
-  Automático

PRECIO 
\$3,500



OBARRIO





CAJA



REF. 424.10.37.20.03.001

DE VILLE PRESTIGE

-  Acero
-  39.5 mm
-  Automático

PRECIO 
\$3,500



OBARRIO





CAJA



REF. 424.13.40.20.06.002

DE VILLE

-  Acero / Oro Ama.
-  36.8 mm
-  Automático

PRECIO 
\$4,000



OBARRIO



REF. 424.20.37.20.02.001

DE VILLE

-  Oro Amarillo
-  31 mm
-  Quartz

PRECIO 
\$4,000





OBARRIO



VINTAGE

DE VILLE

"UFO"

-  Acero
-  40 mm
-  Automático

PRECIO 
\$1,200



OBARRIO



166.094

SEAMASTER

SPEEDMASTER

CONSTELLATION

DE VILLE

DYNAMIC

DE VILLE

 Acero / Oro

 25 mm

 Automático

PRECIO 

\$1,000



OBARRIO



REF. DA 796.2379

DE VILLE

 Oro Amarillo

 37.5 mm

 Automático

PRECIO 

\$30,500



OBARRIO



REF. 4131.31.00



SEAMASTER



SPEEDMASTER

CONSTELLATION

DE VILLE

DYNAMIC

DYNAMIC

-  Acero
-  42 mm
-  Automático

PRECIO 
\$1,200



OBARRIO



REF. 136.033





ORIS
HÖLSTEIN 1904

Oris es una marca suiza independiente fundada en 1904, reconocida por su enfoque en relojes mecánicos accesibles. Especializada exclusivamente en movimientos automáticos.

Oris ha ganado notoriedad por desarrollar calibres propios como la serie Calibre 400 con alta reserva de marcha.

La marca mantiene una filosofía de "lujo funcional", priorizando utilidad sobre ostentación.

AARON  JOYEROS

BIG CROWN



ACERO

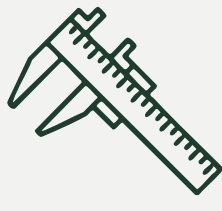

44 mm

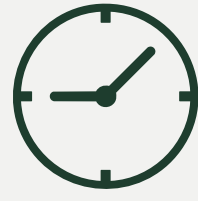

AUTOMÁTICO

PRECIO 
\$1,600

REF. 7629-40



OBARRIO



REGULATEUR



DER MEISTERTAUCHER

TITANIO



49 mm



AUTOMÁTICO



CAJABARRIO



PAPELES

PRECIO 

\$1,500

REF.

01 649 7610





PANERAI



Panerai es una distintiva casa de relojería con raíces italianas y desarrollo suizo, reconocida por su diseño robusto y estética inconfundible. Sus relojes, inspirados en instrumentos militares y de buceo, destacan por cajas imponentes y alta legibilidad.

A lo largo de su historia, la marca ha combinado ingeniería técnica con un estilo único. Panerai representa carácter, herencia y presencia dentro de la relojería de lujo.

FERRARI CRONÓGRAFO

-  Acero
-  45 mm
-  Automático



PRECIO 
\$6,500

-  OBARRIO
-  CAJA
-  PAPELES



REF. FER00004

FERRARI CRONÓGRAFO

-  Acero
-  45 mm
-  Automático



PRECIO 
\$6,500

-  OBARRIO
-  CDE



REF. FER00005

MARINA MILITARE

-  Acero
-  47 mm
-  Automático

PRECIO 
\$9,500

-  OBARRIO
-  CAJA
-  PAPELES



REF. PAM673

RADIOMIR BLACK SEAL

-  Acero
-  45 mm
-  Cuerda Manual



PRECIO 
\$4,200

-  OBARRIO



REF. PAM00183

LUMINOR BLACK SEAL

-  Acero
-  47 mm
-  Automático

PRECIO 
\$5,500

-  OBARRIO



REF. PAM0514

LUMINOR

-  Acero
-  44 mm
-  Cuerda Manual



PRECIO 
\$3,900

-  OBARRIO



REF. PAM112

LUMINOR RATTRAPANTE

-  Acero
-  44 mm
-  Automático

PRECIO 
\$7,300





OBARRIO



REF. PAM00213

RADIOMIR MILITARE

-  Cerámica
-  47 mm
-  Automático

PRECIO 
\$9,000



OBARRIO





PAPELES



REF. PAM00339

LUMINOR

-  Acero
-  44 mm
-  Automático

PRECIO 
\$4,400





OBARRIO



REF. OP6728

LUMINOR SUMERSIBLE

-  Acero
-  47 mm
-  Automático

PRECIO 
\$7,000





OBARRIO



REF. PAM00305

SUBMERSIBLE

-  Acero
-  42 mm
-  Automático

PRECIO 
\$7,500





OBARRIO



REF. PAM00959

LUMINOR

-  Acero / Caucho
-  47 mm
-  Automático

PRECIO 
\$6,000



OBARRIO



CAJA



PAPELES



REF. PAM372



CHARRIOL
GENEVE

Philippe Charriol es una firma de lujo reconocida por su enfoque distintivo en el diseño, inspirado en formas y trenzados característicos. Sus relojes combinan elegancia, creatividad y una identidad visual única dentro del mundo relojero.

A lo largo de su trayectoria, la marca ha desarrollado piezas con fuerte personalidad estética representando estilo, originalidad y sofisticación contemporánea.

AARON  **JOYEROS**

CHARRIOL

 Acero/Baño de Oro

 33.5 mm

 Quartz

PRECIO 

\$1,000



OBARRIO



REF. 53.98.3797





PIAGET

Philippe Charriol es una firma de lujo reconocida por su enfoque distintivo en el diseño, inspirado en formas y trenzados característicos. Sus relojes combinan elegancia, creatividad y una identidad visual única dentro del mundo relojero.

A lo largo de su trayectoria, la marca ha desarrollado piezas con fuerte personalidad estética. Philippe Charriol representa estilo, originalidad y sofisticación contemporánea.

POSSESSION

 Oro Blanco

 28 mm

 Quartz

PRECIO 
\$5,000



OBARRIO



CAJA



PAPELES



REF. 1009275

ALTIPLANO CLOUS DE PARÍS

 Oro 18 k

 26 mm

 Cuerda Manual

PRECIO 
\$4,000





OBARRIO



REF. 549551

HABANA CUERVOS Y SOBRINOS

 Acero y Oro Ama.

 33 mm

 Cuerda Manual

PRECIO 
\$700





OBARRIO



REF. 26310R.00

MISS PROTOCOLE XL

-  Bisel/Diamante
-  40 x 36 mm
-  Quartz

PRECIO 
\$8,500



CDE



REF. P10206

POLO

-  Oro y Diamantes
-  34 mm
-  Automático

PRECIO 
\$20,000



OBARRIO



REF. 24005 M 501 D

RECTANGLE L'ANTIGUA XL

-  Oro Rosa
-  31 X 46 mm
-  Automático

PRECIO 
\$15,200





CDE



REF. PI0076

TANAGRA

-  Oro Amarillo
-  24 mm
-  Quartz

PRECIO 
\$11,850



CDE



REF. 16033







RW
RAYMOND WEIL
GENEVE

Raymond Weil es una reconocida casa suiza que destaca por su elegancia accesible y su inspiración en la música y las artes. Sus relojes combinan diseño clásico, precisión y un enfoque estético refinado.

A lo largo de su trayectoria, la marca ha creado colecciones con fuerte identidad cultural. Raymond Weil representa armonía, tradición y estilo dentro de la relojería suiza.

**ELECTROPLATED
 VINTAGE**

-  Baño de Oro
-  28 mm
-  Quartz

PRECIO 
 \$500





OBARRIO



REF. 9022

NABUCCO

-  Acero
-  44 mm
-  Automático

PRECIO 
 \$600



OBARRIO





CAJA



REF. 3900

**DON GIOVANNI
 COSI GRANDE**

-  Acero
-  29.5 x 31 mm
-  Quartz

PRECIO 
 \$1,200



OBARRIO



REF. 2671-ST-00209

**TOCCATA
 CLASSIC**

-  Acero
-  42 mm
-  Quartz

PRECIO 
 \$900



OBARRIO



CAJA



PAPELES



REF. 5585-ST-60001

TANGO

-  Acero
-  41 mm
-  Quartz

PRECIO 
 \$750



OBARRIO



REF. 8260-ST7-20001







REVUE THOMMEN
Since 1853



La línea de Revue Thommen refleja una sólida tradición relojera suiza, enfocada en la precisión y la funcionalidad. Sus diseños equilibran lo clásico y lo deportivo, con una estética sobria y versátil.

Con una historia ligada también a la aviación y a instrumentos de medición, la marca transmite fiabilidad técnica en cada pieza. Es una opción atractiva para quienes buscan relojes mecánicos bien contruidos, elegantes y con carácter histórico.

REVUE THOMMEN

-  Acero
-  40 mm
-  Automático

PRECIO 
\$1,000

-  CDE
-  CAJA
-  PAPELES



REF. 7001.6





ROGER DUBUIS

Roger Dubuis es una audaz manufactura suiza de alta relojería, reconocida por su diseño vanguardista y complejidad mecánica. Sus relojes destacan por esqueletizados extremos, arquitectura contemporánea y acabados de alto nivel.

A lo largo de su evolución, la marca ha llevado la relojería a un terreno más expresivo y disruptivo. Roger Dubuis representa innovación, exclusividad y una visión radical del lujo relojero.



ROGER DUBUIS



PULSION

ORO ROSA

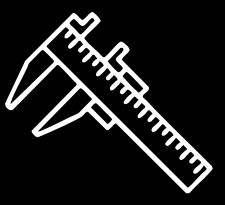

44 mm

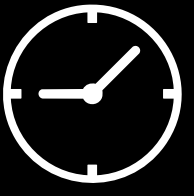

AUTOMÁTICO

PRECIO



\$25,000

PRECIO RETAIL:
\$43,900

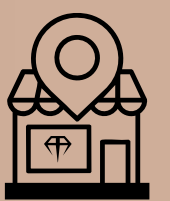

OBARRIO

REF.

RDDDBPU003

AARON  JOYEROS



ROLEX

Rolex es una de las marcas más reconocidas de la alta relojería, famosa por su precisión, durabilidad y diseño atemporal. Sus colecciones combinan innovación técnica con elegancia, convirtiéndose en símbolo de éxito, prestigio y rendimiento en cualquier entorno.

AARON  JOYEROS

AIR KING	DAYTONA	DATEJUST	DAY-DATE	EXPLORER	GMT-MASTER	MILGAUSS
OYSTER PERPETUAL	SEA-DWELLER	SKY-DWELLER	SUBMARINER	YACHT-MASTER	CELLINI	

AIR KING



-  Acero
-  34 mm
-  Automático

 CDE

PRECIO 
 \$4,000

"AFTERMARKET DIAL" REF. 15210

AIR KING	DAYTONA	DATEJUST	DAY-DATE	EXPLORER	GMT-MASTER	MILGAUSS
OYSTER PERPETUAL	SEA-DWELLER	SKY-DWELLER	SUBMARINER	YACHT-MASTER	CELLINI	

AIRKING PRECISION



-  Acero
-  34 mm
-  Automático

PRECIO 
\$4,800



OBARRIO

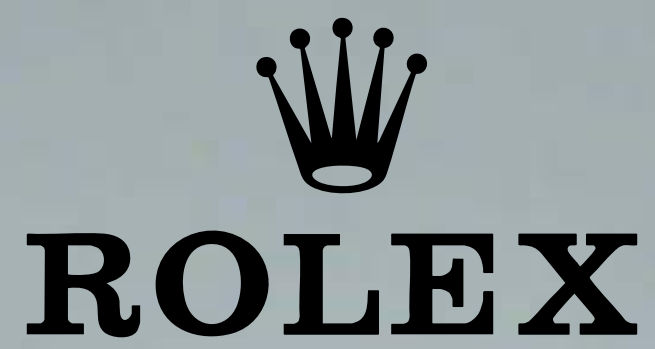

DAYTONA

La línea Daytona es un icono de la relojería deportiva, creada para el automovilismo y la medición precisa del tiempo. Con su característico bisel taquimétrico y diseño elegante, combina alto rendimiento con lujo, consolidándose como uno de los modelos más deseados de Rolex.

DAYTONA

COSMOGRAPH

DAYTONA
JOHN MAYER



OBARRIO

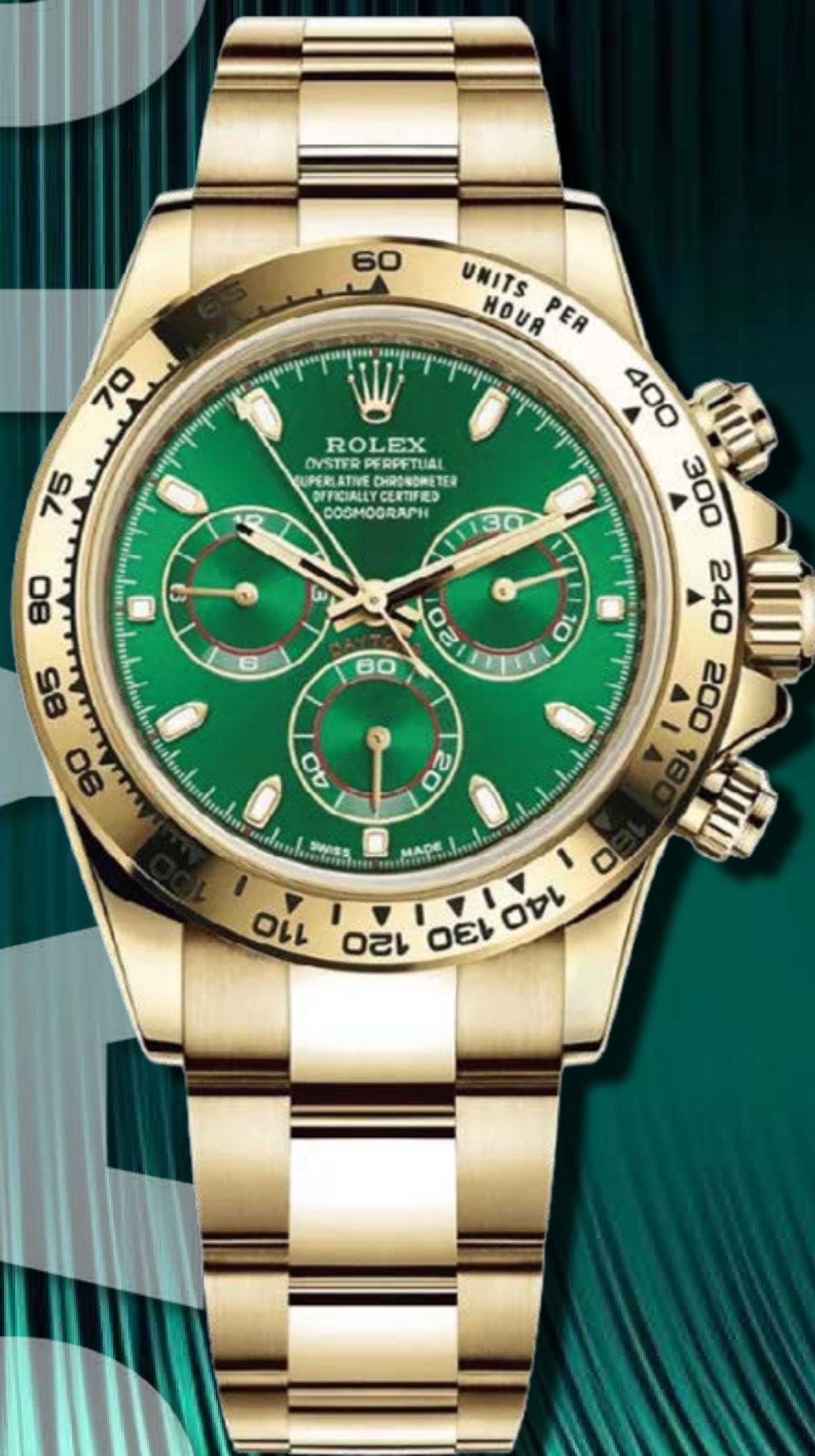

 Oro Amarillo

 40 mm

 Automático

PRECIO 
\$75,000

REF.

ROLEX

DAYTONA

COSMOGRAPH

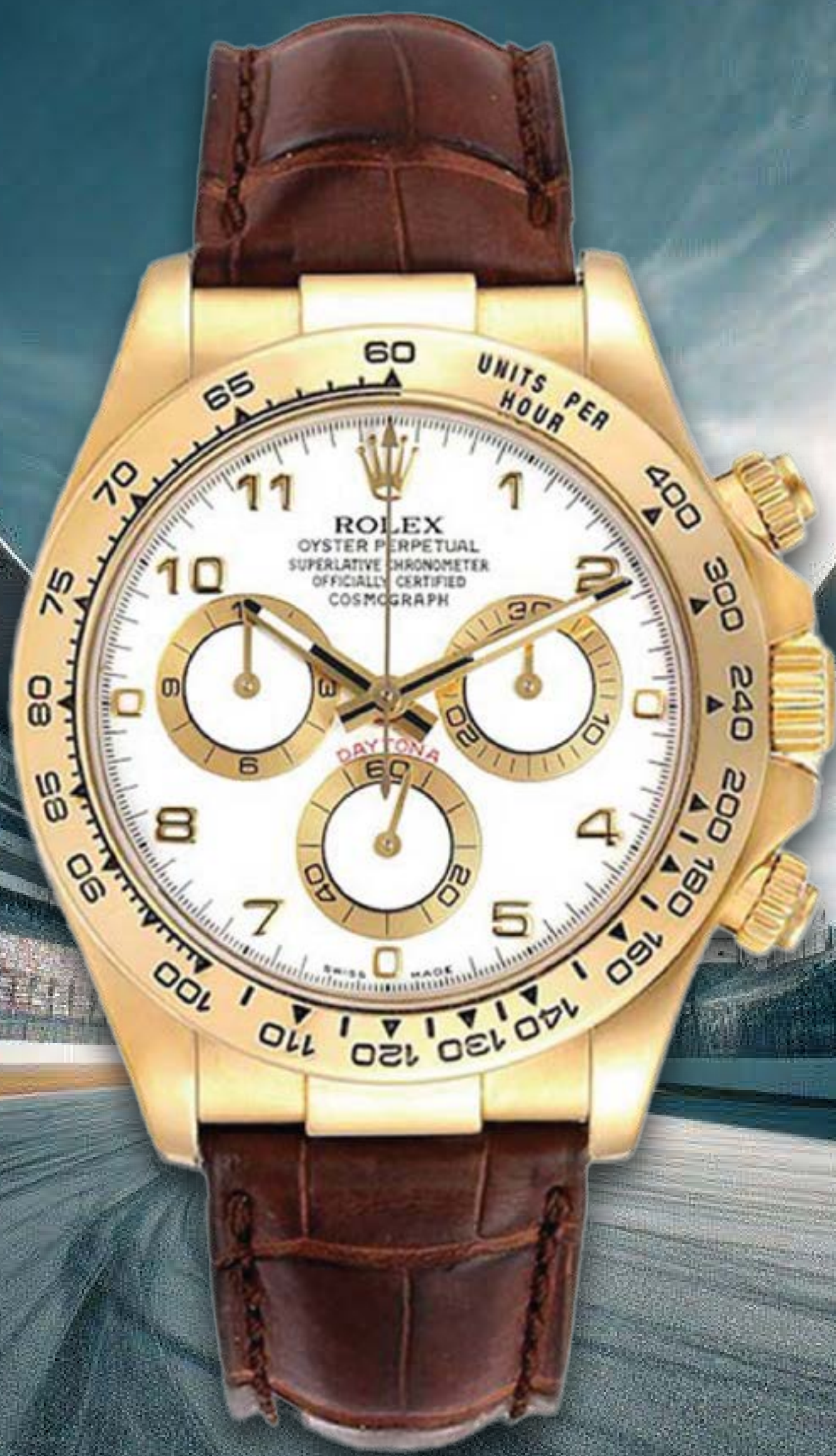

COSTA DEL ESTE



ORO



40 mm



AUTOMÁTICO

PRECIO



\$35,000

116518

REF.

AARON  JOYEROS

AIR KING	DAYTONA	DATEJUST	DAY-DATE	EXPLORER	GMT-MASTER	MILGAUSS
OYSTER PERPETUAL	SEA-DWELLER	SKY-DWELLER	SUBMARINER	YACHT-MASTER	CELLINI	

DAYTONA
COSMOGRAPH

- Acero
- 40 mm
- Automático

PRECIO
\$24,000

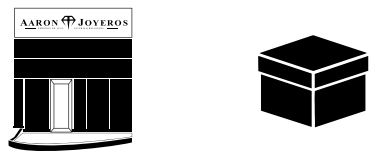

COSTA DEL ESTE CAJA



REF. 116520

DAYTONA

- Acero / Oro
- 40 mm
- Automático

PRECIO
\$21,000

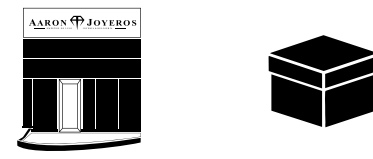

COSTA DEL ESTE CAJA



REF. 116523

DAYTONA

"INVERTED 6"

- Acero / Oro
- 40 mm
- Automático

PRECIO
\$22,000



COSTA DEL ESTE



REF. 16523

DAYTONA

- Oro
- 40 mm
- Automático

PRECIO
\$35,000



OBARRIO CAJA

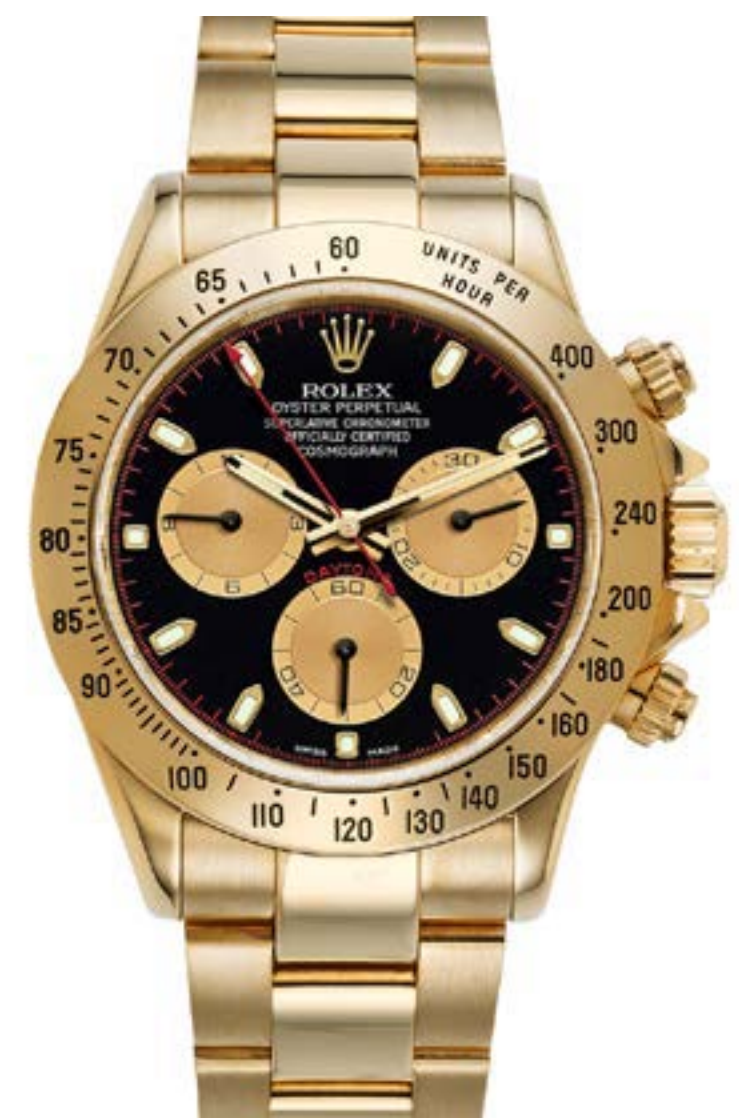

REF. 116528

DAYTONA
OYSTER FLEX

- Oro
- 40 mm
- Automático

PRECIO
\$30,000



OBARRIO CAJA PAPELES



16518

DAYTONA

"MOVIMIENTO ZENITH"

- Acero / Oro
- 40 mm
- Automático

PRECIO
\$19,500



OBARRIO



16523

AIR KING	DAYTONA	DATEJUST	DAY-DATE	EXPLORER	GMT-MASTER	MILGAUSS
OYSTER PERPETUAL	SEA-DWELLER	SKY-DWELLER	SUBMARINER	YACHT-MASTER	CELLINI	

DAYTONA



- Acero
- 40 mm
- Automático

PRECIO \$23,000



REF. 116520

DAYTONA



- Oro Blanco
- 40 mm
- Automático

PRECIO \$35,000

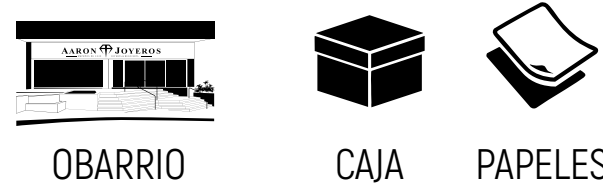

REF. 116509

DAYTONA



- Acero
- 40 mm
- Automático

PRECIO \$22,500



REF. 116520

DAYTONA



- Acero
- 40 mm
- Automático

PRECIO \$23,000



REF. 116520

DAYTONA

"NUEVO A ESTRENAR"

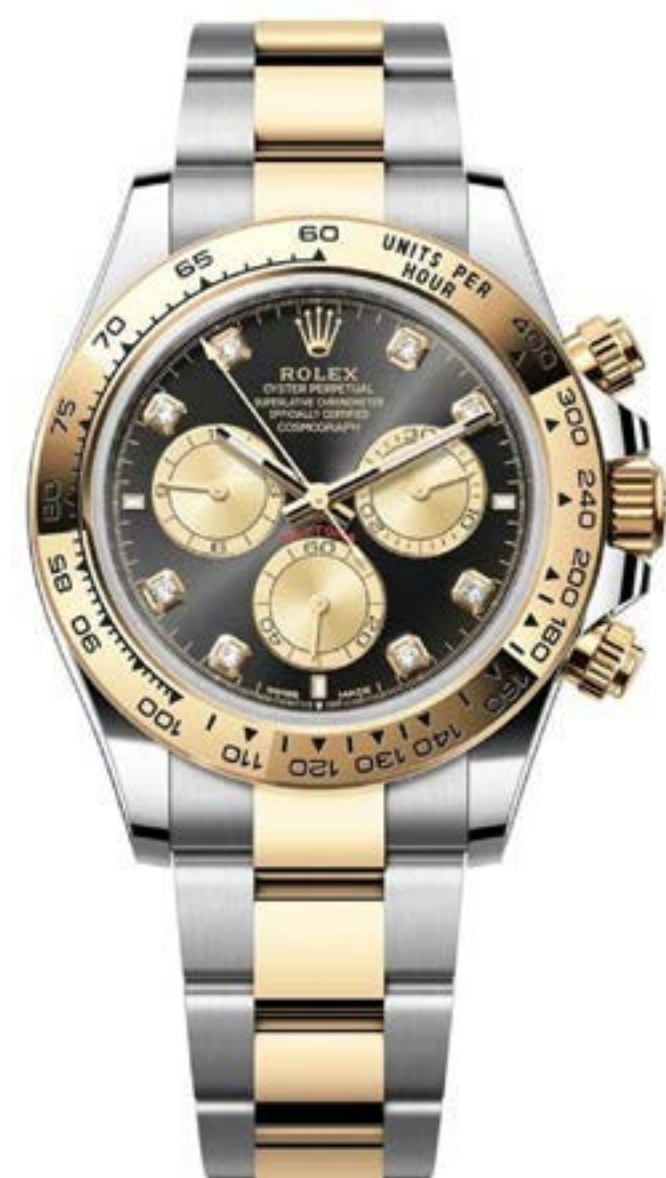

- Acero / Oro
- 40 mm
- Automático

PRECIO \$33,500



REF. 126503

WIMBLEDON

DATEJUST



-  Acero / Oro
-  41 mm
-  Automático



REF 126333

PRECIO 
\$16,500





CAJA



PAPELES

AIR KING	DAYTONA	DATEJUST	DAY-DATE	EXPLORER	GMT-MASTER	MILGAUSS
OYSTER PERPETUAL	SEA-DWELLER	SKY-DWELLER	SUBMARINER	YACHT-MASTER	CELLINI	

DATEJUST WIMBLEDON

-  Acero / Oro
-  41 mm
-  Automático

PRECIO 
\$13,500





OBARRIO



REF. 16333

DATEJUST WIMBLEDON

-  Acero / Oro
-  41 mm
-  Automático

PRECIO 
\$15,500



OBARRIO





PAPELES



REF. 126303



DATEJUST WIMBLEDON

-  Acero / Oro
-  41 mm
-  Automático

PRECIO 
\$14,000



OBARRIO





PAPELES



REF. 126333



DATEJUST WIMBLEDON

-  Acero / Oro
-  41 mm
-  Automático

PRECIO 
\$13,800



OBARRIO



PAPELES



REF. 116333

DATEJUST PEARLMASTER



-  Oro Rosa
-  34 mm
-  Automático

PRECIO 
\$37,000

"FONDO MADRE PERRLA"



CAJA



PAPELES

REF.

81315



OBARRIO

AIR KING	DAYTONA	DATEJUST	DAY-DATE	EXPLORER	GMT-MASTER	MILGAUSS
OYSTER PERPETUAL	SEA-DWELLER	SKY-DWELLER	SUBMARINER	YACHT-MASTER	CELLINI	

DATEJUST

"BISEL DE ORO"

Acero / Oro

41 mm

Automático

PRECIO \$
\$11,000



CDE



REF. 116334

DATEJUST

"BISEL DE ORO"

Acero / Oro

41 mm

Automático

PRECIO \$
\$11,000



OBARRIO



REF. 116334

DATEJUST

Acero / Oro

41 mm

Automático

PRECIO \$
\$11,000



OBARRIO



REF. 116334

DATEJUST

Acero

41 mm

Automático

PRECIO \$
\$10,000



OBARRIO



REF. 126300

DATEJUST

Oro

36 mm

Automático

PRECIO \$
\$12,000



OBARRIO



REF. 116139

DATEJUST

Oro Amarillo

36 mm

Automático

PRECIO \$
\$15,000





OBARRIO



REF. 1601

AIR KING	DAYTONA	DATEJUST	DAY-DATE	EXPLORER	GMT-MASTER	MILGAUSS
OYSTER PERPETUAL	SEA-DWELLER	SKY-DWELLER	SUBMARINER	YACHT-MASTER	CELLINI	

DATEJUST

-  Acero
-  41 mm
-  Automático

PRECIO 
\$9,500





OBARRIO



REF. 116300

DATEJUST

-  Acero
-  41 mm
-  Automático

PRECIO 
\$10,500



OBARRIO



CAJA



PAPELES



REF. 116300

DATEJUST

-  ACERO / ORO
-  36 mm
-  AUTOMÁTICO

PRECIO
\$7,500





OBARRIO



REF. 16013

DATEJUST

-  Acero
-  36 mm
-  Automático

PRECIO 
\$5,500





OBARRIO



REF. 16030

DATEJUST

-  Acero
-  36 mm
-  Automático

PRECIO 
\$8,650



CDE



CAJA





PAPELES



REF. 116200

AIR KING	DAYTONA	DATEJUST	DAY-DATE	EXPLORER	GMT-MASTER	MILGAUSS
OYSTER PERPETUAL	SEA-DWELLER	SKY-DWELLER	SUBMARINER	YACHT-MASTER	CELLINI	

DATEJUST



-  Acero
-  41 mm
-  Automático

PRECIO 
\$9,500



REF. 116300

DATEJUST



-  Acero / Oro
-  41 mm
-  Automático

PRECIO 
\$10,800



REF. 116334

DATEJUST



-  Acero / Oro
-  41 mm
-  Automático

PRECIO 
\$10,500



REF. 116334

DATEJUST



-  Acero / Oro
-  41 mm
-  Automático

PRECIO 
\$11,000



REF. 116334

DATEJUST



-  Acero
-  41 mm
-  Automático

PRECIO 
\$11,500



REF. 116300

DATEJUST

-  Oro
-  36 mm
-  Automático

PRECIO 
\$15,500





REF. VINTAGE

AIR KING	DAYTONA	DATEJUST	DAY-DATE	EXPLORER	GMT-MASTER	MILGAUSS
OYSTER PERPETUAL	SEA-DWELLER	SKY-DWELLER	SUBMARINER	YACHT-MASTER	CELLINI	

DATEJUST



-  Acero
-  36 mm
-  Automático

PRECIO 
\$6,200





REF. 16220

DATEJUST PEARL MASTER

"DIAL MADRE PERLA"



-  Oro/Diamantes
-  29 mm
-  Automático



PRECIO 
\$20,000

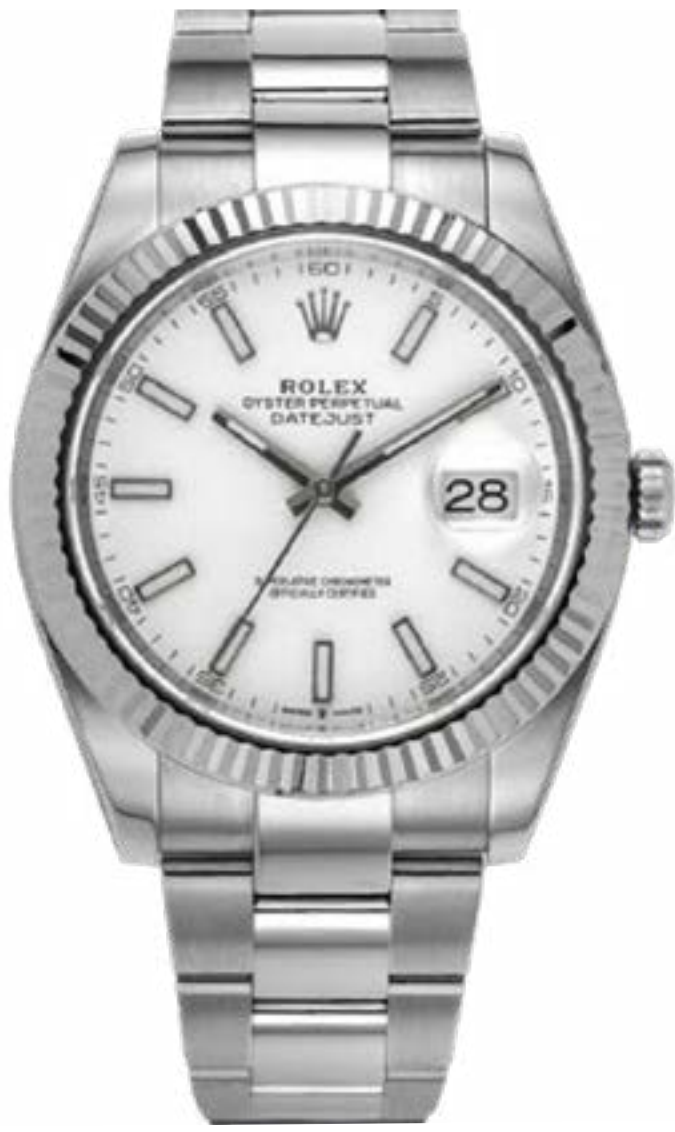

REF. 80299

DATEJUST



-  Acero / Oro
-  41 mm
-  Automático



PRECIO 
\$12,000



REF. 126334

DATEJUST



-  Acero
-  36 mm
-  Automático

PRECIO 
\$6,500



REF. 16030

DATEJUST



-  Acero / Oro
-  36 mm
-  Automático



PRECIO 
\$11,000



REF. 116334

DATEJUST



-  Acero
-  36 mm
-  Automático



PRECIO 
\$5,800



REF. 116234

AIR KING	DAYTONA	DATEJUST	DAY-DATE	EXPLORER	GMT-MASTER	MILGAUSS
OYSTER PERPETUAL	SEA-DWELLER	SKY-DWELLER	SUBMARINER	YACHT-MASTER	CELLINI	

DATEJUST

-  Oro Amarillo
-  36 mm
-  Automático

PRECIO 
\$15,500



REF. 6605

DATEJUST

"DIAL MADRE PERLA"



-  Oro / Diamantes
-  29 mm
-  Automático

PRECIO 
\$30,000



REF. 80318

DATEJUST

-  Oro
-  31 mm
-  Automático

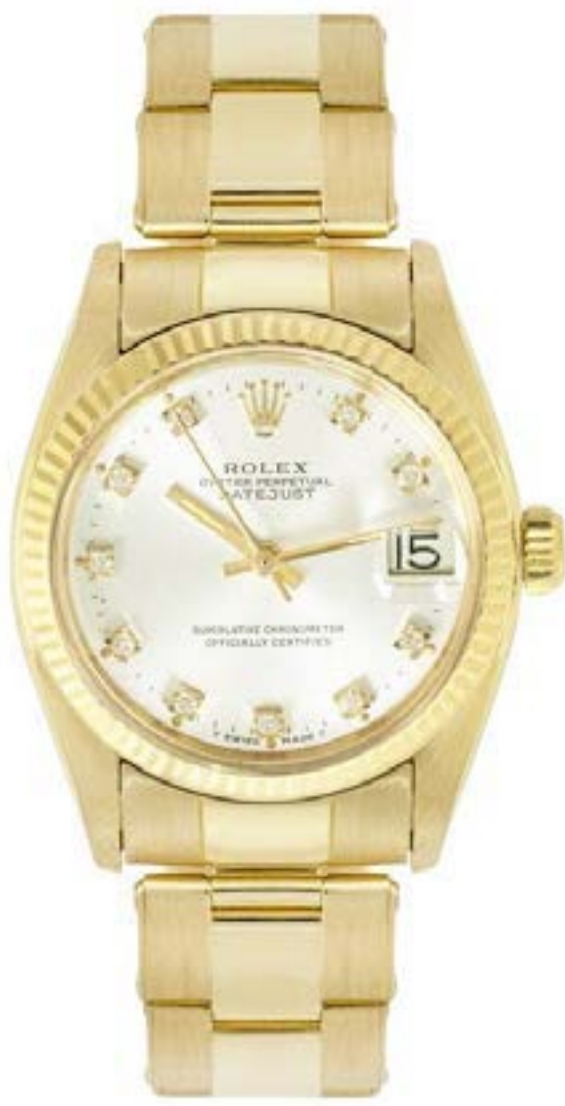

PRECIO 
\$14,000



REF. 6827

DATEJUST

"PULSO NO ORIGINAL DE PLATA"



-  Oro
-  36 mm
-  Automático

PRECIO 
\$8,500



REF. 16018

DATEJUST

-  Acero / Oro
-  26 mm
-  Automático

PRECIO 
\$4,500



REF. 6917

DATEJUST

-  Acero / Oro / Dia.
-  41 mm
-  Automático

PRECIO 
\$14,000



REF. 116333

AIR KING	DAYTONA	DATEJUST	DAY-DATE	EXPLORER	GMT-MASTER	MILGAUSS
OYSTER PERPETUAL	SEA-DWELLER	SKY-DWELLER	SUBMARINER	YACHT-MASTER	CELLINI	



DATEJUST

"PEARLMASTER"

- Acero
- 26 mm
- Automático

PRECIO \$9,500



REF. 179174



DATEJUST

- Acero
- 31 mm
- Automático

PRECIO \$10,500



REF. 278240



DATEJUST

"BISEL & DIAL AFTERMARKET"

- Acero / Diamantes
- 41 mm
- Automático

PRECIO \$12,000



REF. 126300



DATEJUST

- Oro Rosa
- 26 mm
- Automático

PRECIO \$15,000



REF. 179165



DATEJUST

- Oro Rosa
- 26 mm
- Automático

PRECIO \$15,000



REF. 179165



AIR KING	DAYTONA	DATEJUST	DAY-DATE	EXPLORER	GMT-MASTER	MILGAUSS
OYSTER PERPETUAL	SEA-DWELLER	SKY-DWELLER	SUBMARINER	YACHT-MASTER	CELLINI	

DATEJUST

- Acero y Oro
- 26 mm
- Automático

PRECIO

\$4,800



OBARRIO



REF. 69173

DATEJUST

- Acero y Oro
- 41 mm
- Automático

PRECIO

\$16,500



OBARRIO



CAJA



PAPELES



REF. 126303

DATE

- Oro Amarillo
- 34 mm
- Automático

PRECIO

\$20,000



OBARRIO



REF. 1500

DATEJUST

- Oro Rosa
- 41 mm
- Automático

PRECIO

\$14,000



CDE



CAJA



REF. 126301

DATEJUST

- Acero / Oro
- 26 mm
- AUTOMÁTICO

PRECIO

\$9,500



OBARRIO



REF. 179161

DATEJUST

- Acero / Oro Rosa
- 41 mm
- Automático

PRECIO

\$16,000



OBARRIO



CAJA



PAPELES



REF. 126301

AIR KING	DAYTONA	DATEJUST	DAY-DATE	EXPLORER	GMT-MASTER	MILGAUSS
OYSTER PERPETUAL	SEA-DWELLER	SKY-DWELLER	SUBMARINER	YACHT-MASTER	CELLINI	

DATEJUST

 ACERO / DIAMANTES

 26 mm

 AUTOMÁTICO

PRECIO
\$9,000



OBARRIO



CAJA



PAPELES



REF. 179174

DATEJUST

 Acero / Oro

 26 mm

 Automático

PRECIO 
\$5,500



OBARRIO



PAPELES



REF. 69173

DATEJUST

"BISEL DE ORO BLANCO"

 Acero / Oro

 41 mm

 Automático

PRECIO 
\$11,500



OBARRIO



REF. 116334

DATEJUST

"BISEL DE ORO BLANCO"

 Acero / Oro

 41 mm

 Automático

PRECIO 
\$11,500



OBARRIO



REF. 116334

DATEJUST

 Acero / Oro

 31 mm

 Automático

PRECIO 
\$17,000



OBARRIO



PAPELES



REF. 178313

DATEJUST

 Oro

 31 mm

 Automático

PRECIO 
\$8,500





OBARRIO



REF. 6701

AIR KING	DAYTONA	DATEJUST	DAY-DATE	EXPLORER	GMT-MASTER	MILGAUSS
OYSTER PERPETUAL	SEA-DWELLER	SKY-DWELLER	SUBMARINER	YACHT-MASTER	CELLINI	

LADY-DATEJUST

-  Acero
-  26 mm
-  Automático

PRECIO 
\$6,500



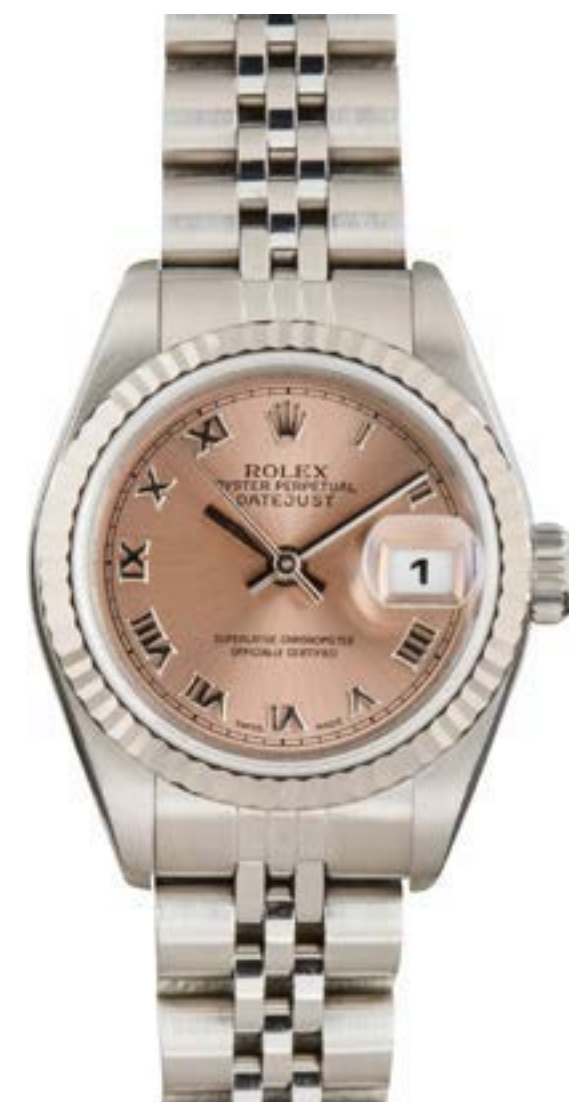

OBARRIO



REF. 69174

DATEJUST

-  Acero / Oro
-  26 mm
-  Automático

PRECIO 
\$5,500





OBARRIO



REF. 69173

DATEJUST

-  Acero / Oro
-  36 mm
-  Automático

PRECIO 
\$6,500





OBARRIO



REF. 16233

DATEJUST

-  Acero
-  36 mm
-  Automático

PRECIO 
\$5,000



OBARRIO



CAJA



PAPELES



REF. 1603

DATEJUST

-  ACERO / ORO
-  41 mm
-  AUTOMÁTICO

PRECIO
\$17,000



OBARRIO



CAJA



REF. 126333

AIR KING	DAYTONA	DATEJUST	DAY-DATE	EXPLORER	GMT-MASTER	MILGAUSS
OYSTER PERPETUAL	SEA-DWELLER	SKY-DWELLER	SUBMARINER	YACHT-MASTER	CELLINI	



CAJA



DAY-DATE



OBARRIO

-  Oro
-  41 mm
-  Automático

PRECIO 
\$39,800



REF. 218239

AIR KING	DAYTONA	DATEJUST	DAY-DATE	EXPLORER	GMT-MASTER	MILGAUSS
OYSTER PERPETUAL	SEA-DWELLER	SKY-DWELLER	SUBMARINER	YACHT-MASTER	CELLINI	

DAY-DATE



REF. 18038

Oro Amarillo

36 mm

Automático

PRECIO \$23,000



CDE

DAY-DATE

"CONFETI DIAL"



REF. 1803

Oro Amarillo

36 mm

Automático

PRECIO \$24,000



OBARRIO

DAY-DATE

DIAL LAPISLAZULI Y DIAMANTES AFTERMARKET



REF. 18238

Oro Amarillo

36 mm

Automático

PRECIO \$25,000



OBARRIO

DAY-DATE



REF. 18038

Oro Amarillo

36 mm

Automático

PRECIO \$20,000



OBARRIO

DAY-DATE



REF. 18238

Oro Amarillo

36 mm

Automático

PRECIO \$23,000



CDE

DAY-DATE



REF. 18238

Oro Amarillo

36 mm

Automático

PRECIO \$20,500



OBARRIO



CAJA

AIR KING	DAYTONA	DATEJUST	DAY-DATE	EXPLORER	GMT-MASTER	MILGAUSS
OYSTER PERPETUAL	SEA-DWELLER	SKY-DWELLER	SUBMARINER	YACHT-MASTER	CELLINI	

DAY-DATE



- Oro Amarillo
- 36 mm
- Automático

PRECIO
\$16,800



OBARRIO

REF. 1803

DAY-DATE

"BISEL CON DIAMANTES"



- Oro Amarillo
- 36 mm
- Automático

PRECIO
\$22,000



CDE

REF. 18048

DAY-DATE



- Oro / Diamantes
- 36 mm
- Automático

PRECIO
\$19,400



OBARRIO



CAJA

REF. 18038

DAY-DATE

"DIAL DE DIAMANTES"



- Oro / Diamantes
- 36 mm
- Automático

PRECIO
\$21,050



OBARRIO

REF. 18238

DAY-DATE



- Oro blanco
- 36 mm
- Automático

PRECIO
\$22,000



OBARRIO

REF. 18239

DAY-DATE



- Oro
- 36 mm
- Automático

PRECIO
\$17,800



OBARRIO



REF. 1803

AIR KING	DAYTONA	DATEJUST	DAY-DATE	EXPLORER	GMT-MASTER	MILGAUSS
OYSTER PERPETUAL	SEA-DWELLER	SKY-DWELLER	SUBMARINER	YACHT-MASTER	CELLINI	

DAY-DATE



REF. 1803

-  Oro
-  36 mm
-  Automático

PRECIO 

\$9,000





OBARRIO

DAY-DATE

"BISEL CON DIAMANTES"



REF. 1803

-  Oro
-  36 mm
-  Automático

PRECIO 

\$15,000



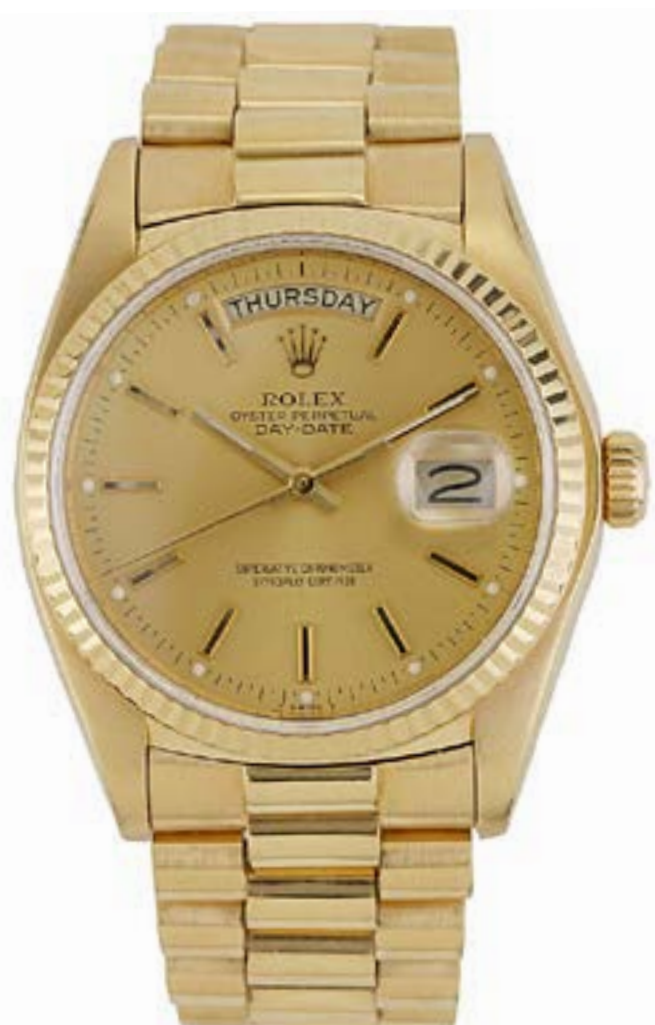

OBARRIO

DAY-DATE



REF. 1803

-  Oro
-  36 mm
-  Automático

PRECIO 

\$16,600





OBARRIO

DAY-DATE



REF. 118209

-  Oro blanco
-  36 mm
-  Automático

PRECIO 

\$25,500



OBARRIO



CAJA



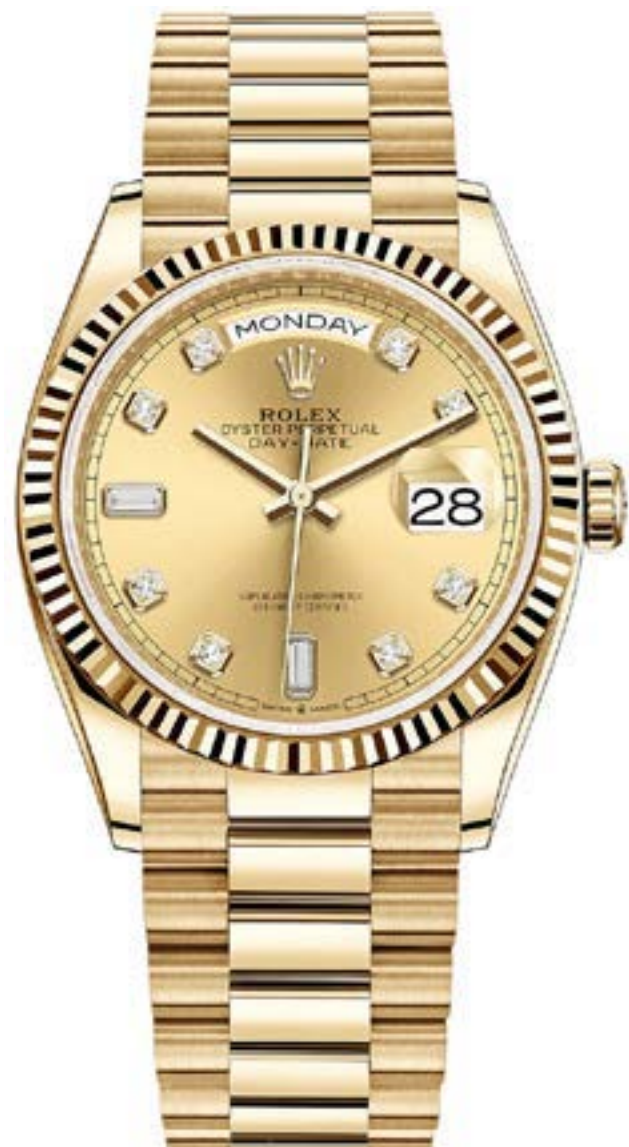

PAPELES

DAY-DATE



REF. 128238

-  Oro
-  36 mm
-  Automático

PRECIO 

\$46,000



OBARRIO



CAJA





PAPELES

DAY-DATE

"COSTUM BEZEL & DIAL"



REF. 1803

-  Oro
-  36 mm
-  Automático

PRECIO 

\$15,000



OBARRIO

AIR KING	DAYTONA	DATEJUST	DAY-DATE	EXPLORER	GMT-MASTER	MILGAUSS
OYSTER PERPETUAL	SEA-DWELLER	SKY-DWELLER	SUBMARINER	YACHT-MASTER	CELLINI	

DAY-DATE

 Oro Amarillo

 40 mm

 Automático

PRECIO 

\$48,000



OBARRIO



CAJA



PAPELES



REF. 228238

DAY-DATE

 Oro Rosa

 40 mm

 Automático

PRECIO 

\$48,000



OBARRIO



REF. 228235



ROLEX
EXPLORER



El Explorer es un modelo emblemático de Rolex, inspirado en el espíritu de la exploración y la aventura. Presentado en 1953 tras la histórica ascensión al Monte Everest, fue diseñado para ofrecer máxima legibilidad, resistencia y precisión en condiciones extremas.

AIR KING	DAYTONA	DATEJUST	DAY-DATE	EXPLORER	GMT-MASTER	MILGAUSS
OYSTER PERPETUAL	SEA-DWELLER	SKY-DWELLER	SUBMARINER	YACHT-MASTER	CELLINI	

EXPLORER II

-  Acero
-  40 mm
-  Automático

PRECIO 
\$8,000





OBARRIO



REF. 16570

EXPLORER II

-  Acero
-  40 mm
-  Automático

PRECIO 
\$8,000





OBARRIO



REF. 16570



EXPLORER II

-  Acero
-  40 mm
-  Automático

PRECIO 
\$8,000



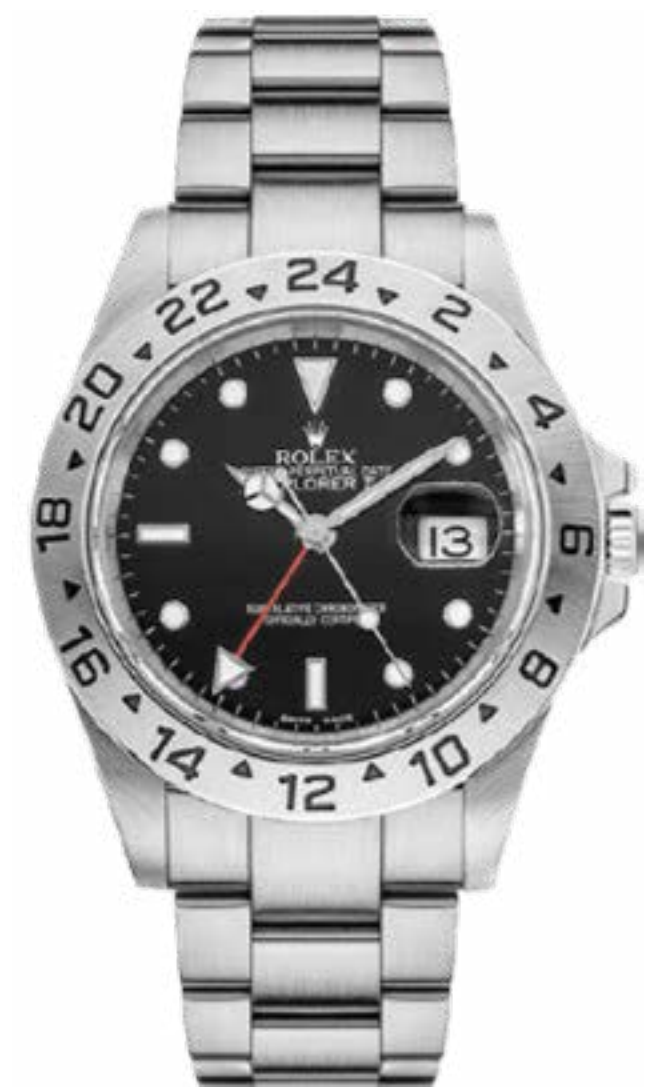

OBARRIO



REF. 16570



EXPLORER II

-  Acero
-  40 mm
-  Automático

PRECIO 
\$9,500





CDE



REF. 16570

EXPLORER II

-  Acero
-  40 mm
-  Automático

PRECIO 
\$8,000



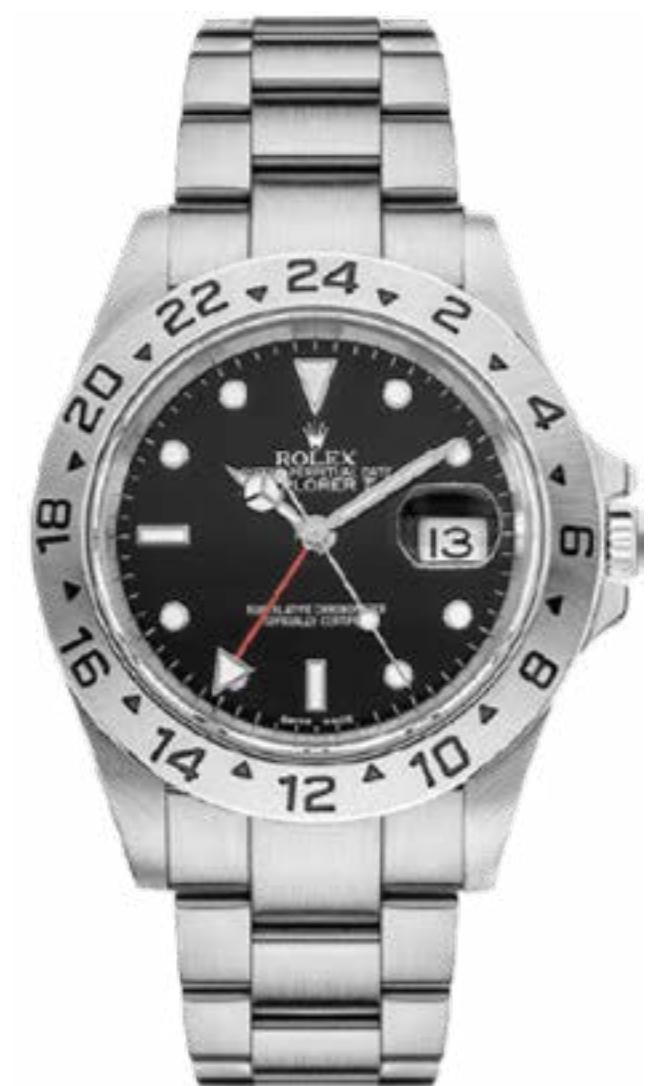

OBARRIO



REF. 16570

AIR KING	DAYTONA	DATEJUST	DAY-DATE	EXPLORER	GMT-MASTER	MILGAUSS
OYSTER PERPETUAL	SEA-DWELLER	SKY-DWELLER	SUBMARINER	YACHT-MASTER	CELLINI	

EXPLORER II

-  Acero
-  42 mm
-  Automático



PRECIO 
\$11,800

-  OBARRIO
-  PAPELESCAJA



REF. 216570

EXPLORER II

-  Acero
-  42 mm
-  Automático

PRECIO 
\$11,800

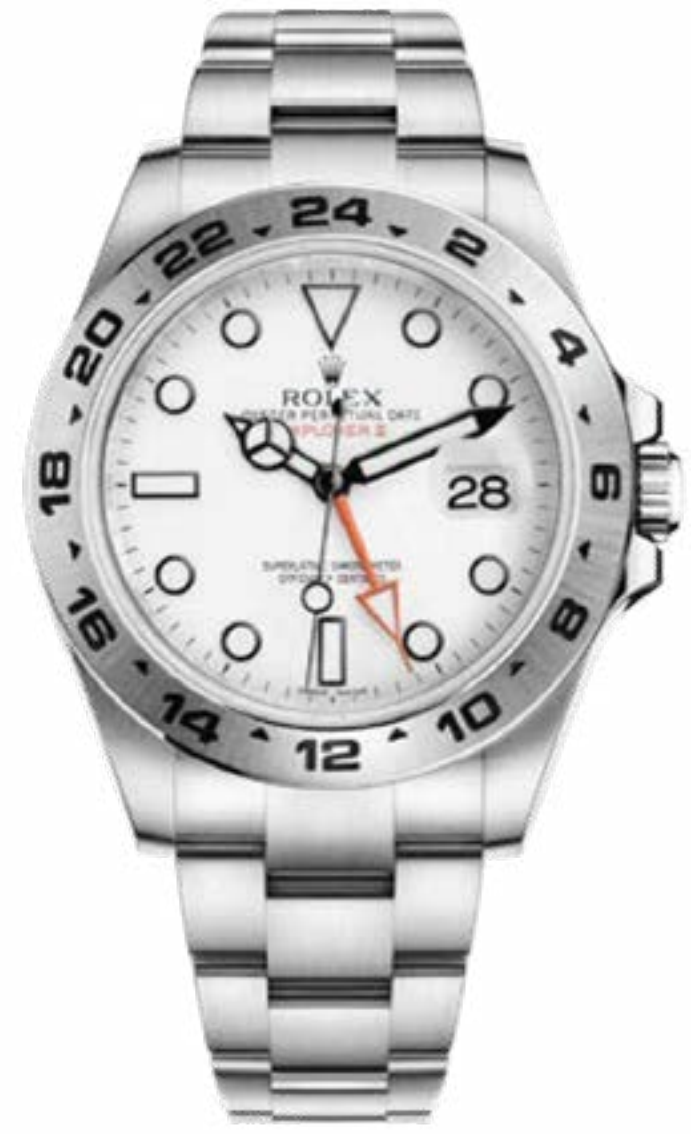

-  OBARRIO
-  PAPELESCAJA





REF. 216570



EXPLORER II

-  Acero
-  42 mm
-  Automático

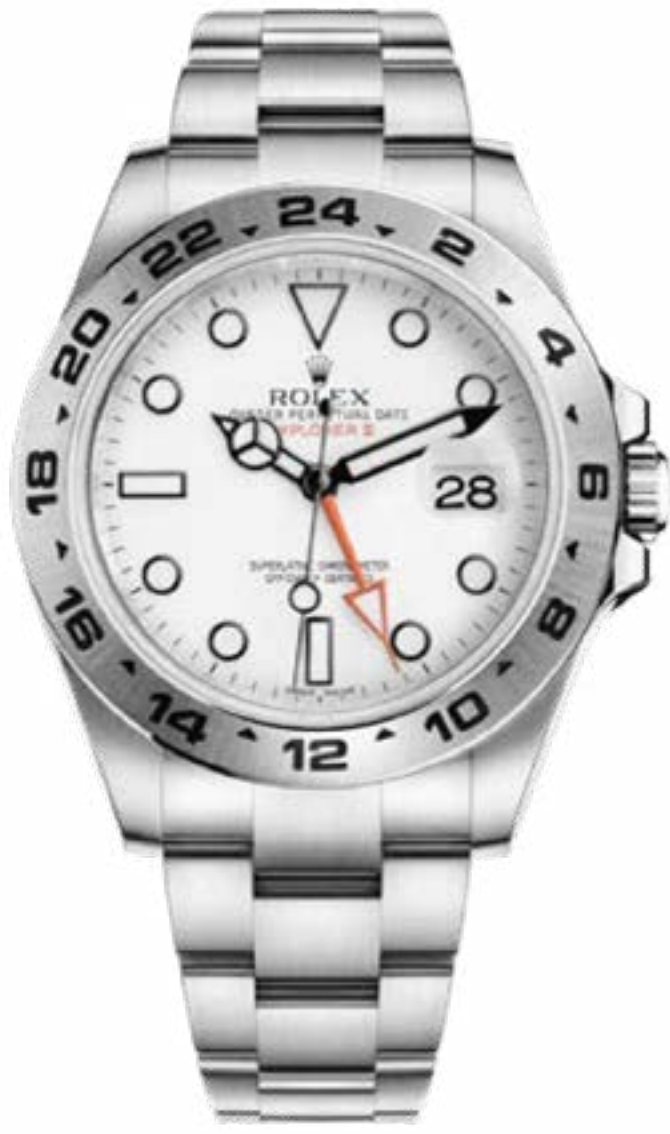

PRECIO 
\$10,500

-  OBARRIO
-  PAPELESCAJA



REF. 216570

EXPLORER II

-  Acero
-  42 mm
-  Automático

PRECIO 
\$11,000

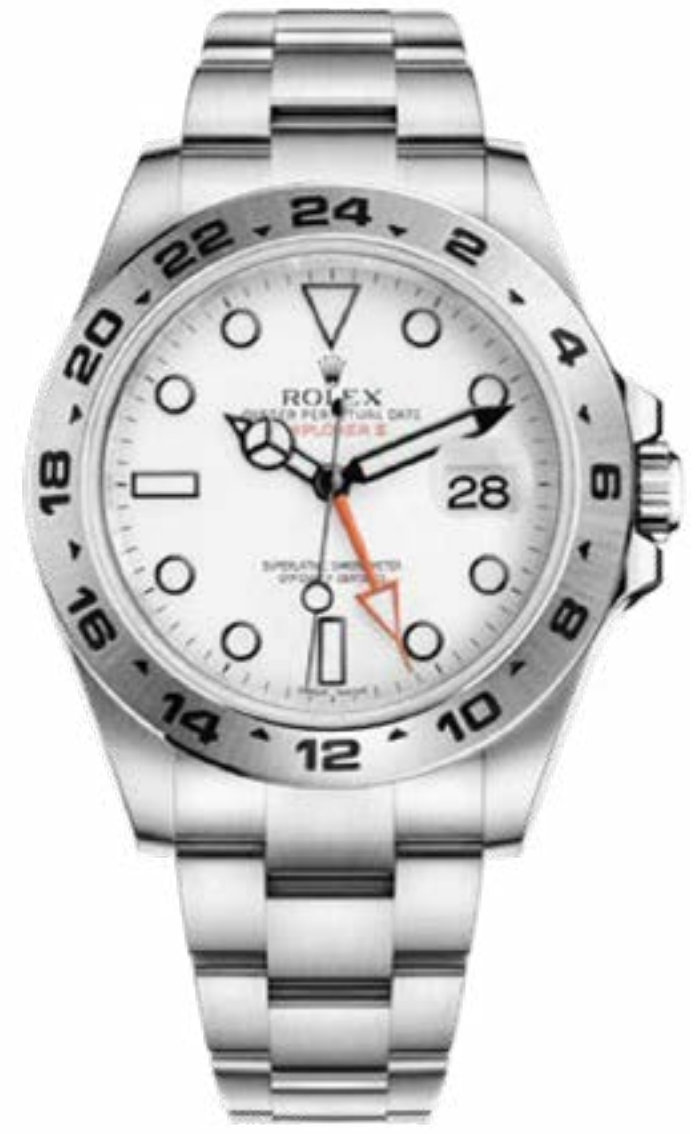

-  OBARRIO



REF. 216570



EXPLORER II

-  Acero
-  42 mm
-  Automático

PRECIO 
\$11,000

-  OBARRIO



REF. 216570

AIR KING	DAYTONA	DATEJUST	DAY-DATE	EXPLORER	GMT-MASTER	MILGAUSS
OYSTER PERPETUAL	SEA-DWELLER	SKY-DWELLER	SUBMARINER	YACHT-MASTER	CELLINI	

EXPLORER II

- Acero
- 40 mm
- Automático

PRECIO 
\$8,500



OBARRIO



REF. 16570

EXPLORER II

- Acero
- 40 mm
- Automático

PRECIO 
\$8,500



OBARRIO



REF. 16570

EXPLORER II

- Acero
- 40 mm
- Automático

PRECIO 
\$14,000



OBARRIO



REF. 16570

EXPLORER II

- Acero
- 40 mm
- Automático

PRECIO 
\$10,000



OBARRIO



REF. 16570





AIR KING	DAYTONA	DATEJUST	DAY-DATE	EXPLORER	GMT-MASTER	MILGAUSS
OYSTER PERPETUAL	SEA-DWELLER	SKY-DWELLER	SUBMARINER	YACHT-MASTER	CELLINI	



ROOT BEER

GMT-MASTER



-  Oro
-  40 mm
-  Automático

REF. 1675

PRECIO 
\$50,000



OBARRIO



REF. 126710BLN

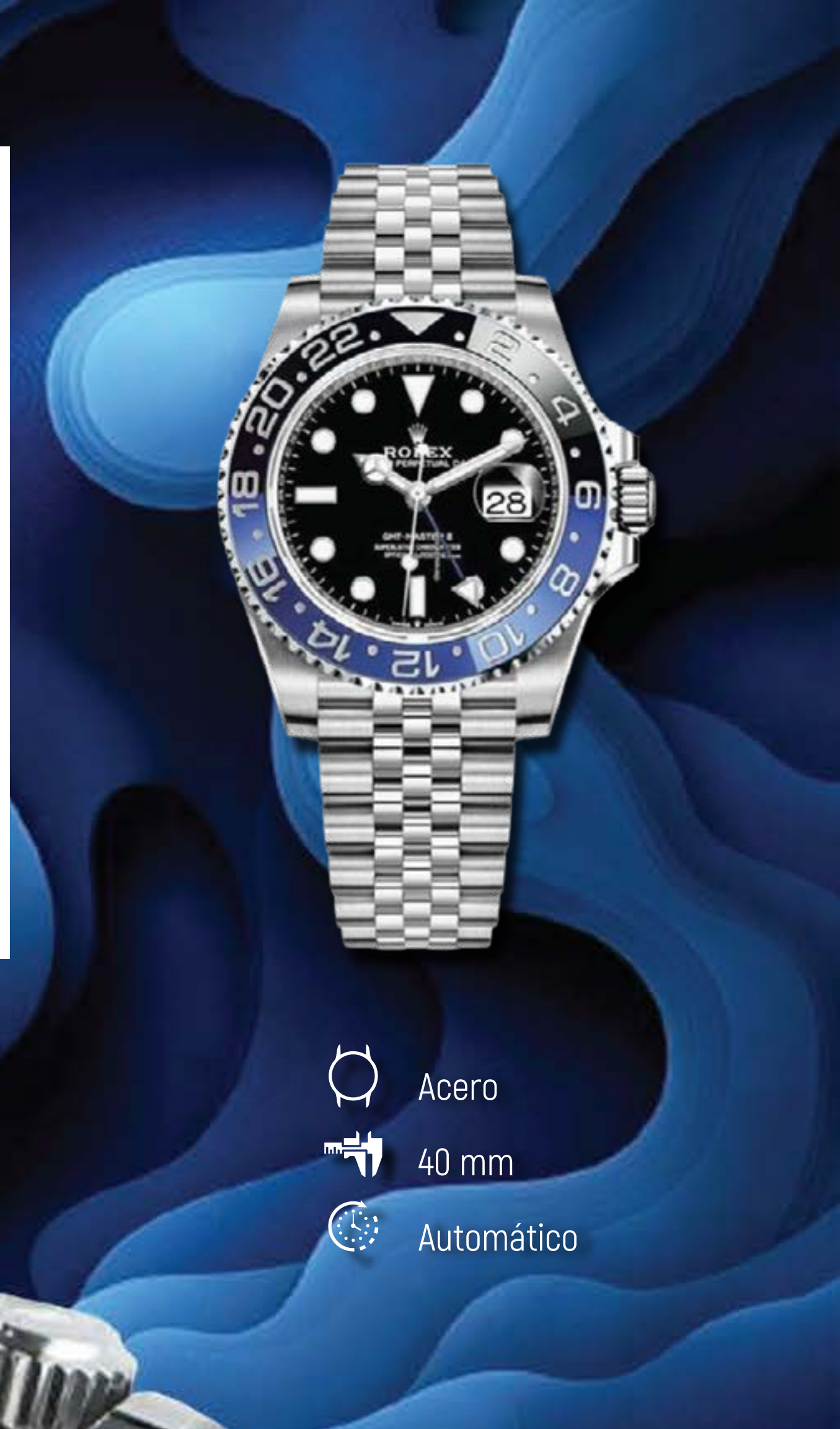

-  Acero
-  40 mm
-  Automático



PRECIO 
\$19,000

GMT-MASTER II BATGIRL



GMT-MASTER II



Acero



40 mm



Automático



CAJA



PAPELES

PRECIO



\$19,000



OBARRIO

REF.

126710BLNR



BATMAN

AARON  JOYEROS

AIR KING	DAYTONA	DATEJUST	DAY-DATE	EXPLORER	GMT-MASTER	MILGAUSS
OYSTER PERPETUAL	SEA-DWELLER	SKY-DWELLER	SUBMARINER	YACHT-MASTER	CELLINI	

BATMAN
GMT-MASTER II

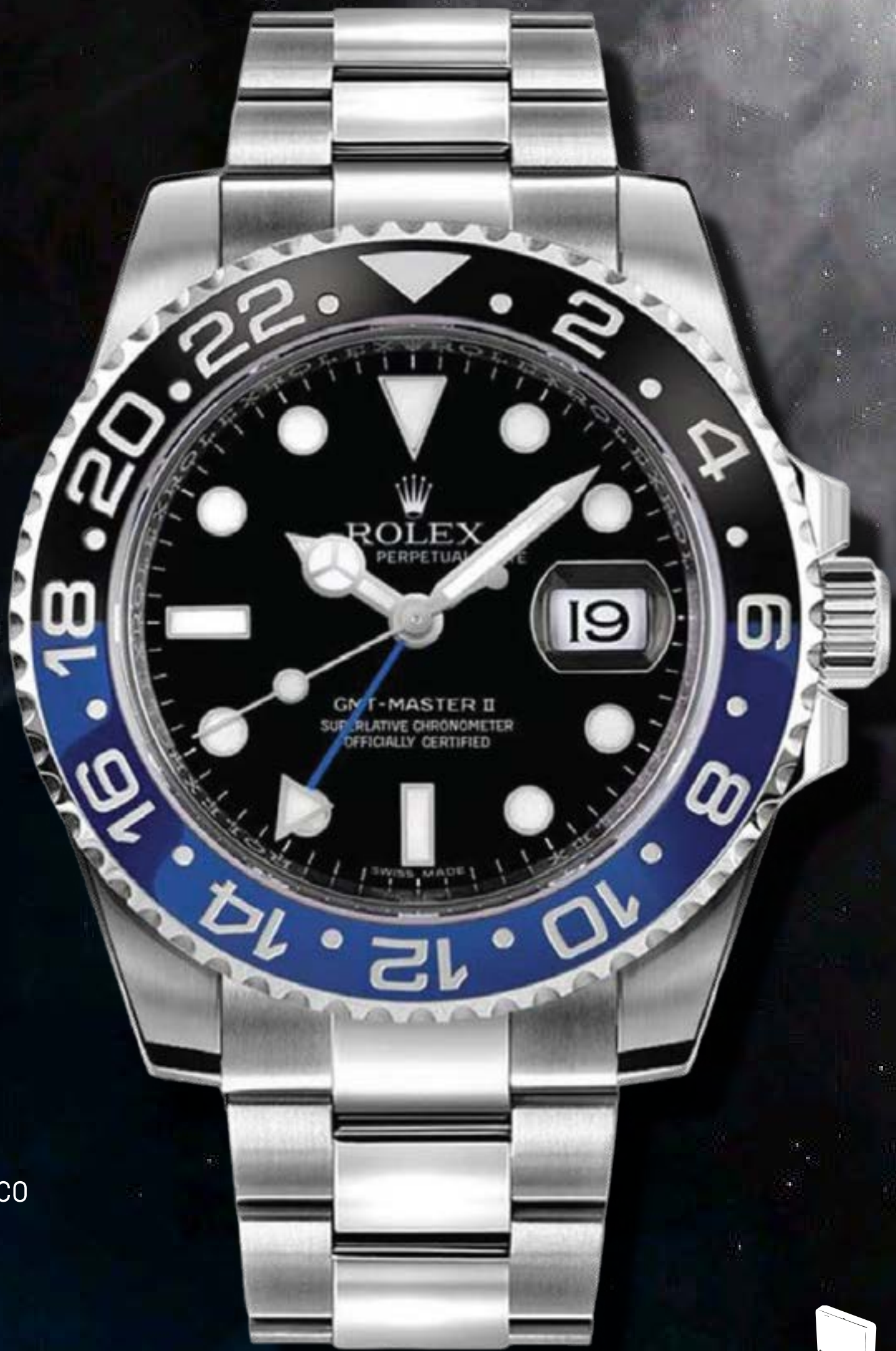

-  Acero
-  40 mm
-  Automático

PRECIO 
\$16,800



REF. 116710BLNR







GMT-MASTER II



PEPSI

-  Acero
-  40 mm
-  Automático



OBARRIO

PRECIO
\$13,000



16700

AIR KING	DAYTONA	DATEJUST	DAY-DATE	EXPLORER	GMT-MASTER	MILGAUSS
OYSTER PERPETUAL	SEA-DWELLER	SKY-DWELLER	SUBMARINER	YACHT-MASTER	CELLINI	

GMT-MASTER II

ROOT BEER

 Acero / Oro

 40 mm

 Automático

PRECIO 

\$14,800



CDE



CAJA



REF. 16753



GMT-MASTER II

"SPYDER DIAL" 

 Acero

 40 mm

 Automático

PRECIO 

\$10,800



OBARRIO

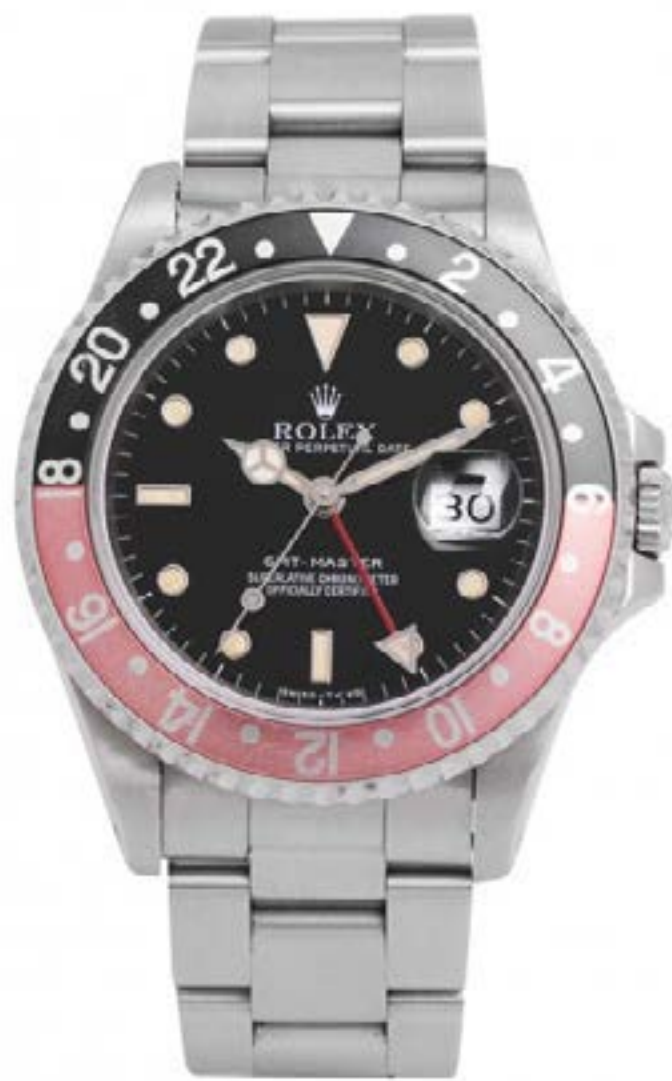

REF. 16700



GMT-MASTER II

BATGIRL

 ACERO

 40 mm

 AUTOMÁTICO

PRECIO

\$20,500



OBARRIO



CAJA



PAPELES

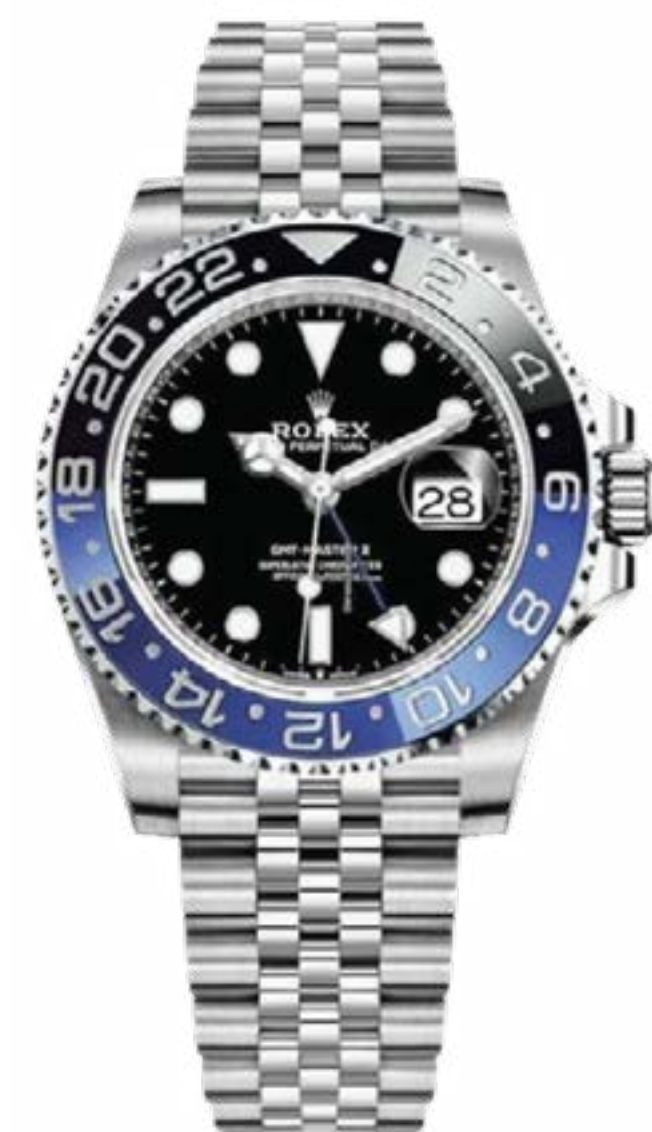

REF. 126710BLN

AIR KING	DAYTONA	DATEJUST	DAY-DATE	EXPLORER	GMT-MASTER	MILGAUSS
OYSTER PERPETUAL	SEA-DWELLER	SKY-DWELLER	SUBMARINER	YACHT-MASTER	CELLINI	

GMT-MASTER

"NIPLE DIAL"

- Acero / Oro
- 40 mm
- Automático

PRECIO 
\$10,000



CDE



REF. 16753

GMT-MASTER

- Acero / Oro
- 40 mm
- Automático

PRECIO 
\$11,500



OBARRIO

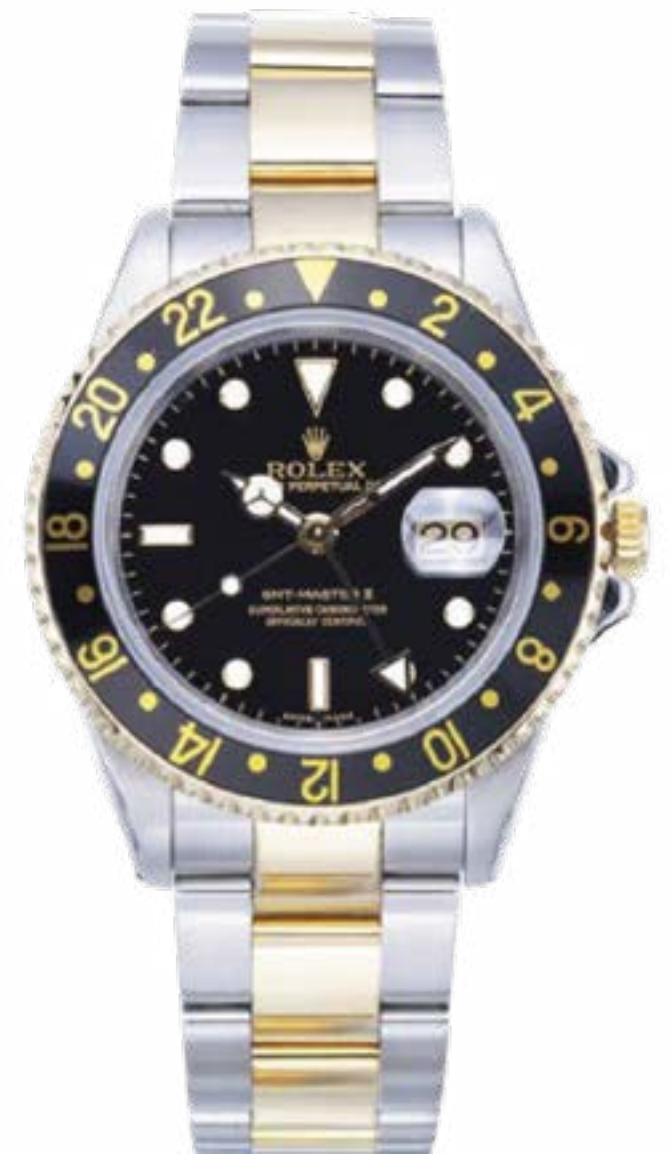

REF. 16713

GMT-MASTER

- Acero / Oro
- 40 mm
- Automático

PRECIO 
\$10,500



OBARRIO



REF. 1675

GMT-MASTER

"NIPLE DIAL"

- Acero / Oro
- 40 mm
- Automático

PRECIO 
\$9,000



OBARRIO

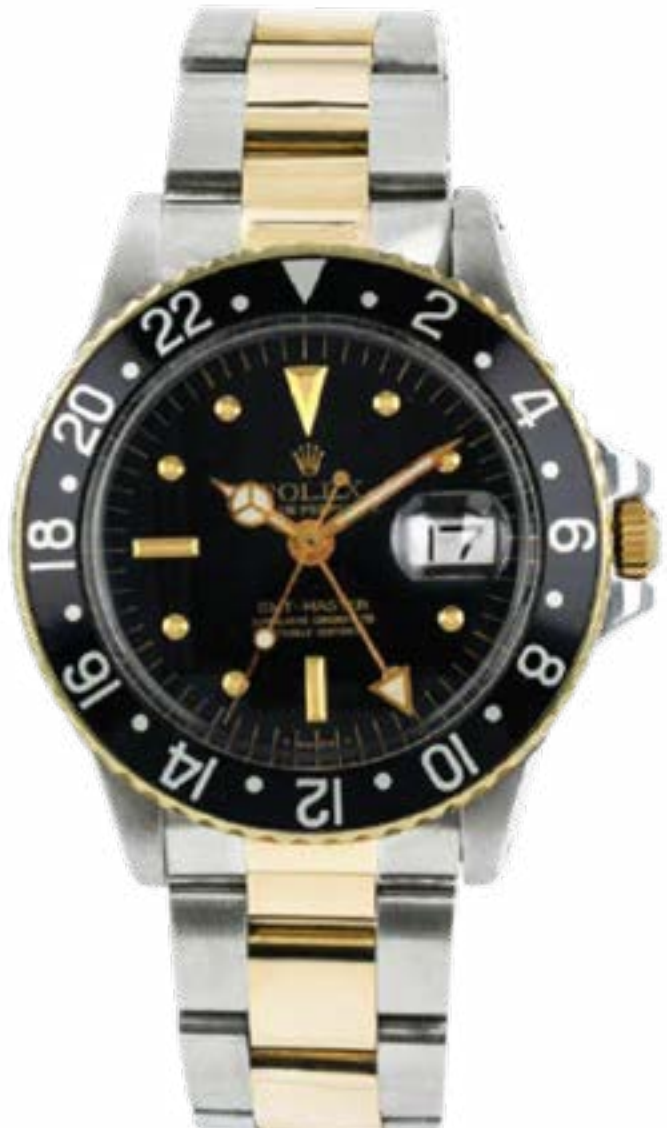

REF. 1675

GMT-MASTER

- Acero / Oro
- 40 mm
- Automático

PRECIO 
\$10,800



OBARRIO





REF. 16753



AIR KING	DAYTONA	DATEJUST	DAY-DATE	EXPLORER	GMT-MASTER	MILGAUSS
OYSTER PERPETUAL	SEA-DWELLER	SKY-DWELLER	SUBMARINER	YACHT-MASTER	CELLINI	

GMT-MASTER II

-  Acero
-  40 mm
-  Automático



PRECIO 
\$13,000



REF. 116710LN



GMT-MASTER II

-  Acero
-  40 mm
-  Automático

PRECIO 
\$14,000



REF. 16750



OYSTER PERPETUAL
MILGAUSS



OBARRIO



-  Acero
-  40 mm
-  Automático

PRECIO 
\$9,800

REF. 116400



ROLEX



OYSTER PERPETUAL



Acero



39 mm



Automático

PRECIO



\$8,500



114300

REF





O BARRIO



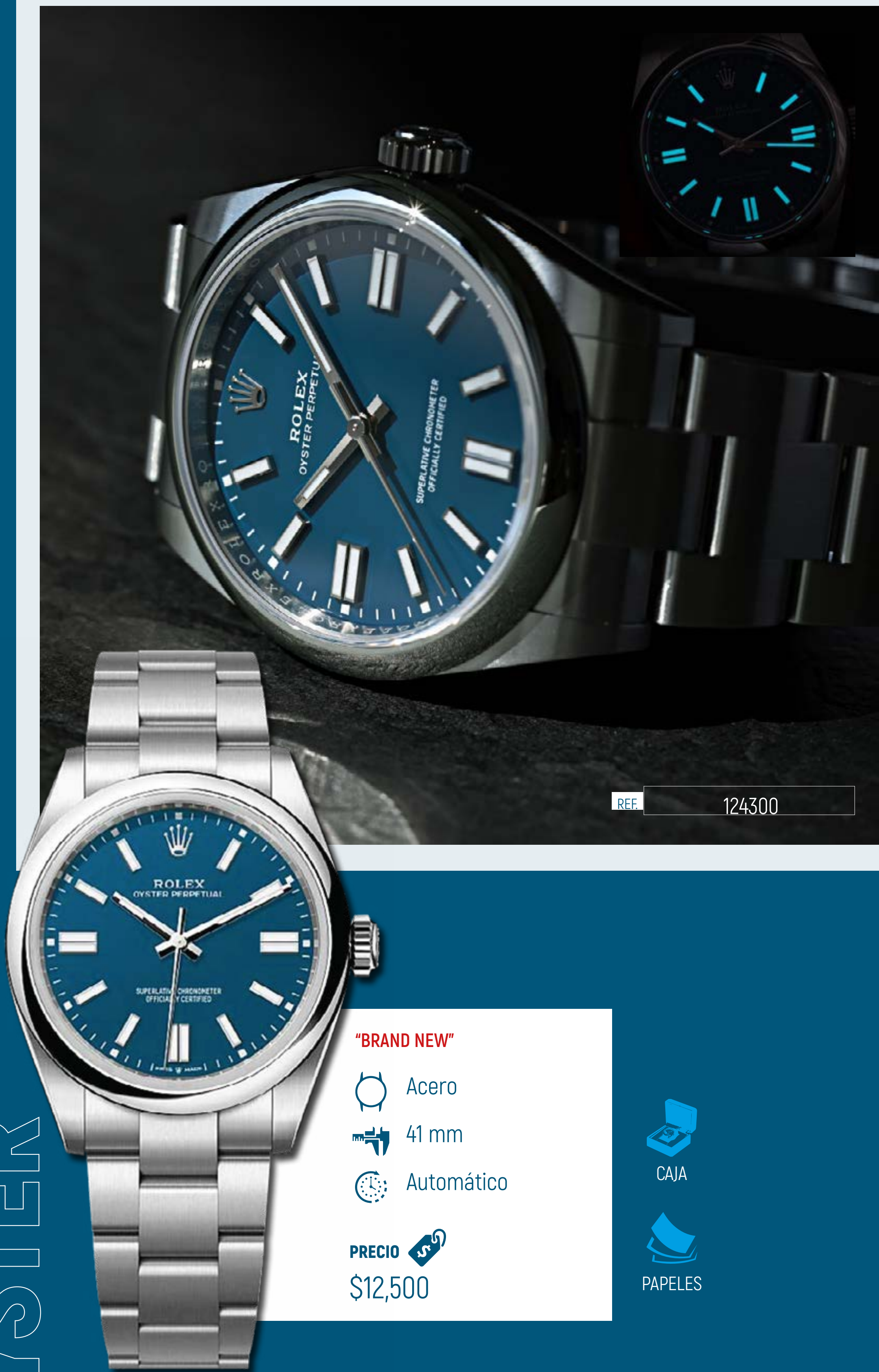

PERPETUAL

OYSTER



"BRAND NEW"

-  Acero
-  41 mm
-  Automático

PRECIO 
\$12,500



CAJA



PAPELES

AIR KING	DAYTONA	DATEJUST	DAY-DATE	EXPLORER	GMT-MASTER	MILGAUSS
OYSTER PERPETUAL	SEA-DWELLER	SKY-DWELLER	SUBMARINER	YACHT-MASTER	CELLINI	

OYSTER PERPETUAL

"TIFFANY DIAL"

- Acero
- 31 mm
- Automático

PRECIO \$12,500

- OBARRIO
- PAPELESCAJA



REF. 27200

OYSTER PERPETUAL CORAL ROJO

- Acero
- 31 mm
- Automático

PRECIO \$11,000

- OBARRIO
- PAPELES



REF. 27200

OYSTER PERPETUAL

- Oro Amarillo
- 31 mm
- Cuerda Manual

PRECIO \$8,600

- CDE



REF. 6619

OYSTER PERPETUAL

- Oro
- 34 mm
- Automático

PRECIO \$11,500

- OBARRIO



REF. 100S

OYSTER PERPETUAL

- Oro Amarillo
- 24 mm
- Automático

PRECIO \$9,500

- OBARRIO
- CAJA



REF. 6617

OYSTER PERPETUAL DATE

- Acero / Oro
- 25 mm
- Automático

PRECIO \$4,000

- OBARRIO





REF. 6517

AIR KING	DAYTONA	DATEJUST	DAY-DATE	EXPLORER	GMT-MASTER	MILGAUSS
OYSTER PERPETUAL	SEA-DWELLER	SKY-DWELLER	SUBMARINER	YACHT-MASTER	CELLINI	



OYSTER PERPETUAL

"DÓMINOS PIZZA"

"NUEVO A ESTRENAR"

-  Acero
-  36 mm
-  Automático



PRECIO 
\$9,000

-  OBARRIO
-  PAPELESCAJA



REF. 116000

OYSTER PERPETUAL

-  Acero
-  36 mm
-  Automático

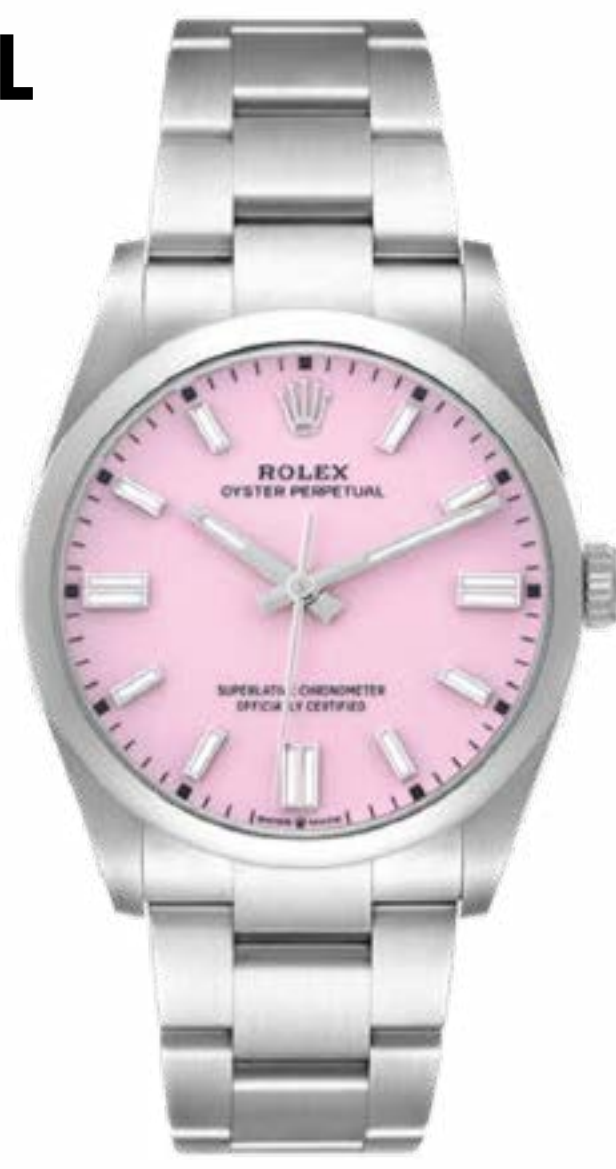

PRECIO 
\$13,000

-  OBARRIO
-  PAPELESCAJA



REF. 126000

OYSTER PERPETUAL

-  Acero
-  24 mm
-  Automático



PRECIO 
\$2,500

-  OBARRIO



REF. 6516

OYSTER PERPETUAL

-  Oro
-  36 mm
-  Automático



PRECIO 
\$11,500

-  OBARRIO



REF. 1005

OYSTER PERPETUAL

-  Acero / Oro
-  26 mm
-  Automático

PRECIO 
\$4,000

-  OBARRIO



REF. 6917

SEA-DWELLER

DEEPSEA

136660

 Acero

 44 mm

 Automático

PRECIO 
\$17,500





ROLEX

SEASWELLER



CDE



Acero



40 mm



Automático

PRECIO



\$9,250



16600

REF

ROLEX

SKY-DWELLER



 Oro Rosa

 42 mm

 Automático

PRECIO 
\$44,000

OBARRIO

PAPELES

REF 326235



AARON  JOYEROS

AIR KING	DAYTONA	DATEJUST	DAY-DATE	EXPLORER	GMT-MASTER	MILGAUSS
OYSTER PERPETUAL	SEA-DWELLER	SKY-DWELLER	SUBMARINER	YACHT-MASTER	CELLINI	



SKY-DWELLER



-  Acero / Oro
-  42 mm
-  Automático

PRECIO 
\$22,500



REF 326933



PAPELESCAJA



OBARRIO

SKY-DWELLER

El Rolex Sky-Dweller es uno de los modelos más sofisticados de Rolex, creado para viajeros frecuentes que requieren funcionalidad y elegancia en una sola pieza. Combina un calendario anual que distingue automáticamente los meses de 30 y 31 días con un segundo huso horario visible mediante un disco excéntrico en la esfera.



ROLEX



Oro Rosa 18 k



42 mm



Automático

PRECIO



\$45,000



CDE



CAJA



REF.

326935



AARON  JOYEROS

AIR KING	DAYTONA	DATEJUST	DAY-DATE	EXPLORER	GMT-MASTER	MILGAUSS
OYSTER PERPETUAL	SEA-DWELLER	SKY-DWELLER	SUBMARINER	YACHT-MASTER	CELLINI	

SKY-DWELLER

-  Acero / Oro
-  42 mm
-  Automático

PRECIO 
\$22,800



-  OBARRIO
-  PAPELESCAJA
- 





REF. 336933



SKY-DWELLER

-  Oro Rosa
-  42 mm
-  Automático

PRECIO 
\$49,500

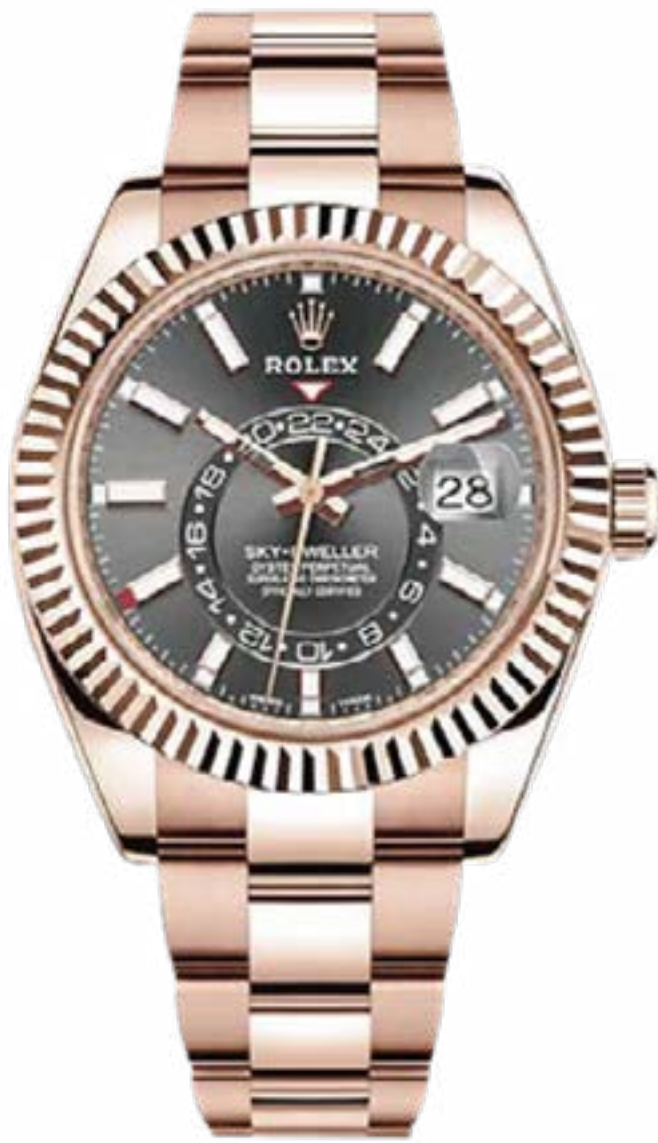

-  OBARRIO
-  PAPELESCAJA
- 



REF. 326935



SKY-DWELLER

-  Acero
-  42 mm
-  Automático

PRECIO 
\$24,500

-  OBARRIO
-  PAPELESCAJA
- 



REF. 326934



ROLEX

SUBMARINER

El Rolex Submariner, lanzado en 1953 por Rolex, es uno de los relojes de buceo más icónicos del mundo. Diseñado para ofrecer máxima resistencia y precisión bajo el agua, combina funcionalidad profesional con una estética elegante y atemporal, convirtiéndose en un símbolo de lujo deportivo y referencia en la alta relojería.



SUBMARINER

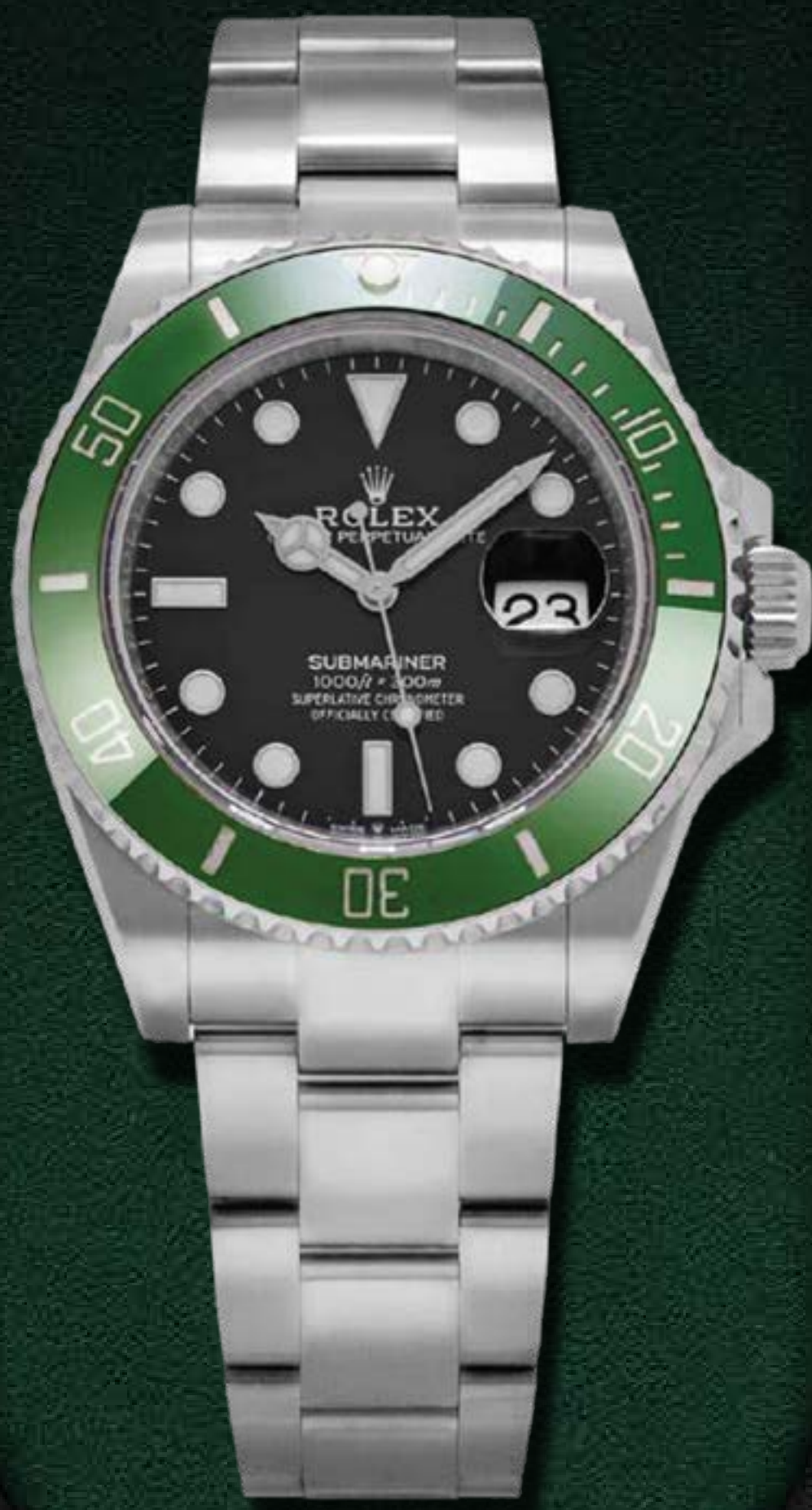

"NUEVO A ESTRENAR"

STARBUCKS



Acero



40 mm



Automático

PRECIO



\$17,800



PAPELESCAJA

REF.

126610LV

AARON  JOYEROS

AIR KING	DAYTONA	DATEJUST	DAY-DATE	EXPLORER	GMT-MASTER	MILGAUSS
OYSTER PERPETUAL	SEA-DWELLER	SKY-DWELLER	SUBMARINER	YACHT-MASTER	CELLINI	

SUBMARINER
KERMIT

"50 ANIVERSARIO"



- Acero
- 40 mm
- Automático

PRECIO \$12,500



OBARRIO



REF. 16610LV

SUBMARINER
KERMIT

"50 ANIVERSARIO"

- Acero
- 40 mm
- Automático

PRECIO \$12,500



CDE



CAJA



REF. 16610LV

SUBMARINER
KERMIT

- Acero
- 40 mm
- Automático

PRECIO \$12,000



OBARRIO



REF. 16610LV

SUBMARINER
KERMIT

- Acero
- 40 mm
- Automático

PRECIO \$12,500



OBARRIO



CAJA



REF. 16610LV

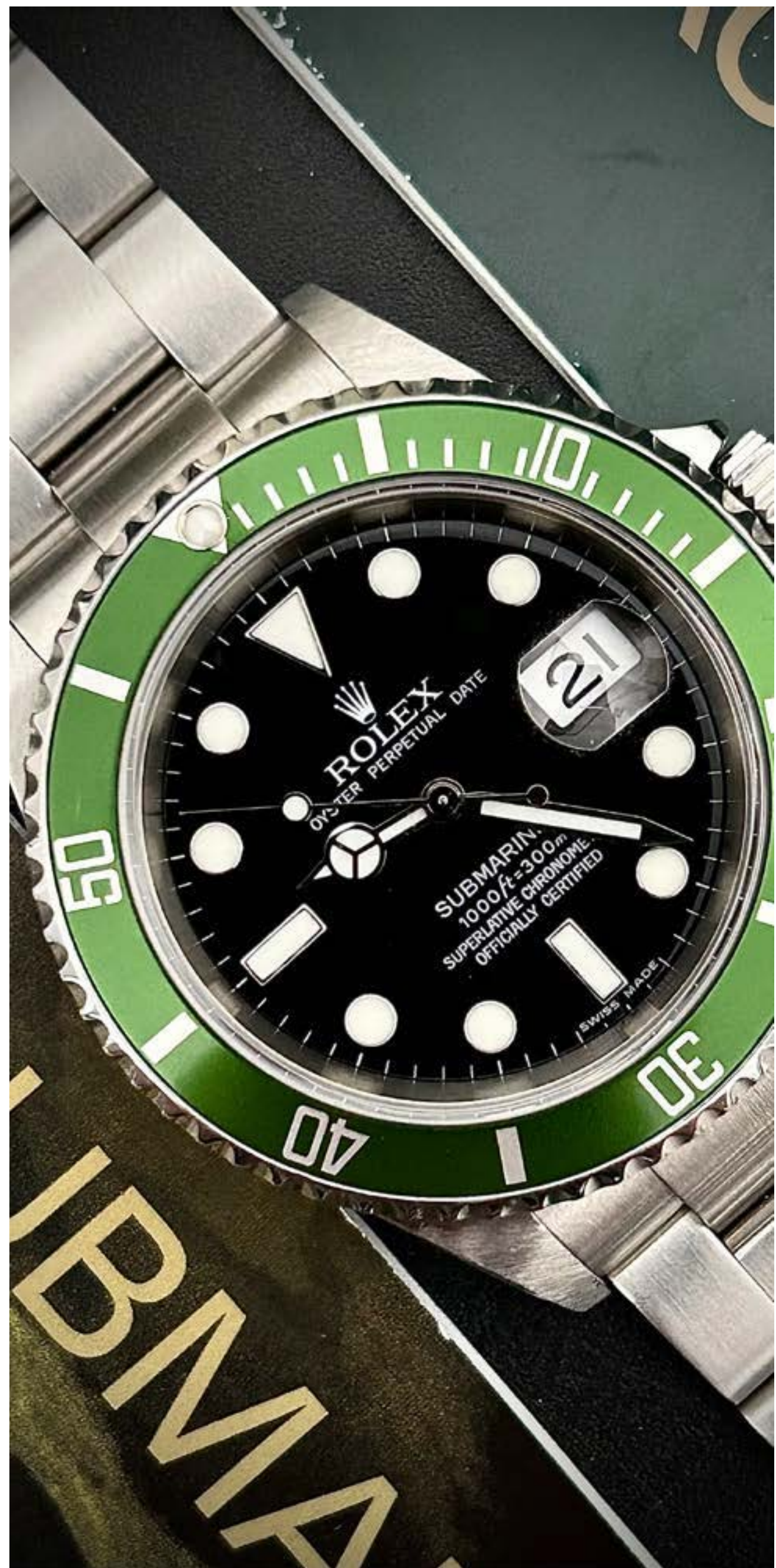



ROLEX

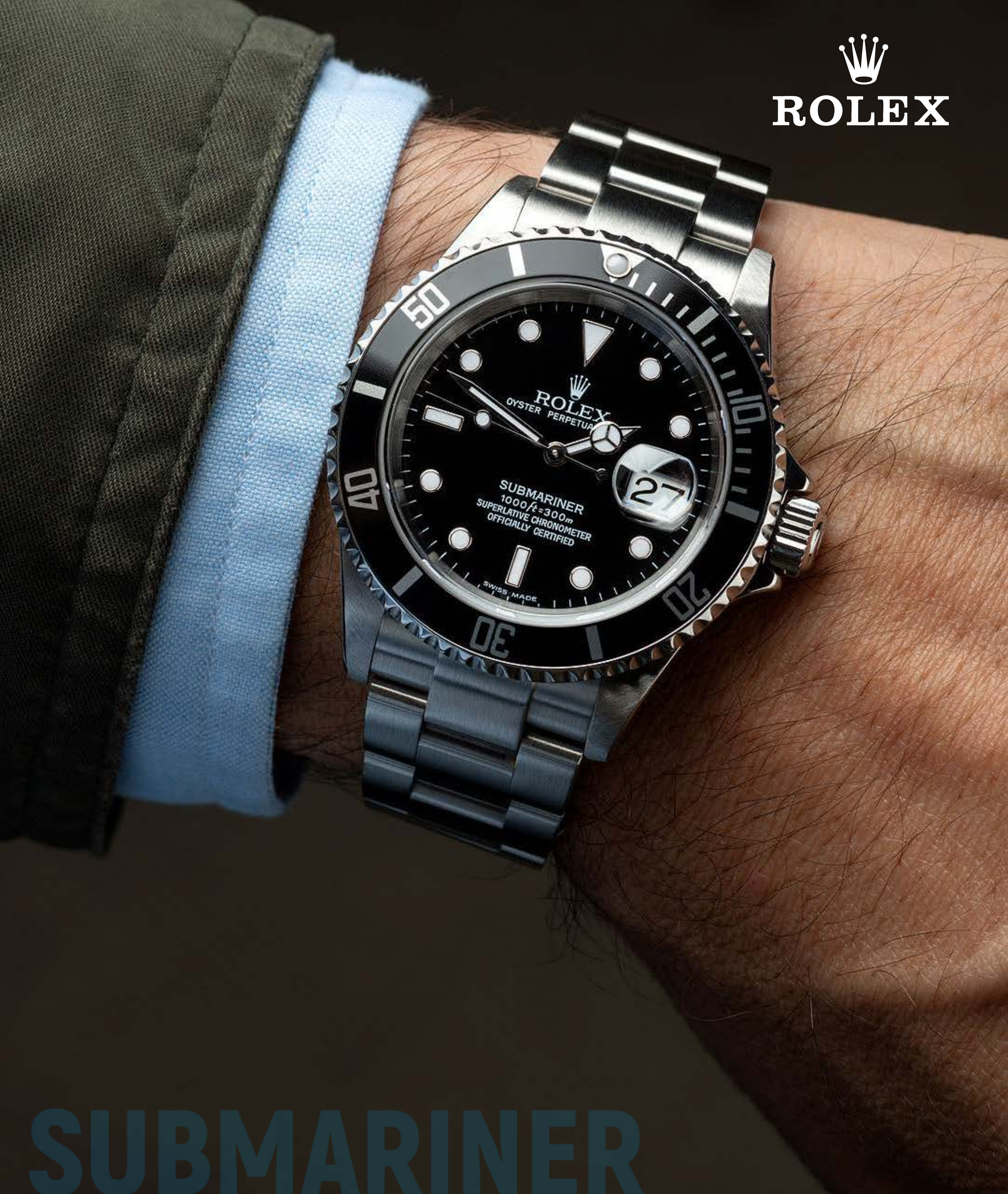

SUBMARINER



Acero



40 mm



Automático

PRECIO



\$10,000

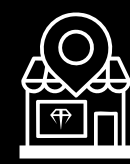

OBARRIO



16610

REF

AARON  JOYEROS

AIR KING	DAYTONA	DATEJUST	DAY-DATE	EXPLORER	GMT-MASTER	MILGAUSS
OYSTER PERPETUAL	SEA-DWELLER	SKY-DWELLER	SUBMARINER	YACHT-MASTER	CELLINI	

SUBMARINER DATE

-  Acero
-  40 mm
-  Automático

PRECIO 
\$9,600





OBARRIO



REF. 16610

SUBMARINER DATE

-  Acero
-  40 mm
-  Automático

PRECIO 
\$9,700



OBARRIO





CAJA



REF. 16610



SUBMARINER DATE

-  Acero
-  40 mm
-  Automático

PRECIO 
\$10,000





OBARRIO



REF. 16610

SUBMARINER DATE

-  Acero
-  40 mm
-  Automático

PRECIO 
\$10,000



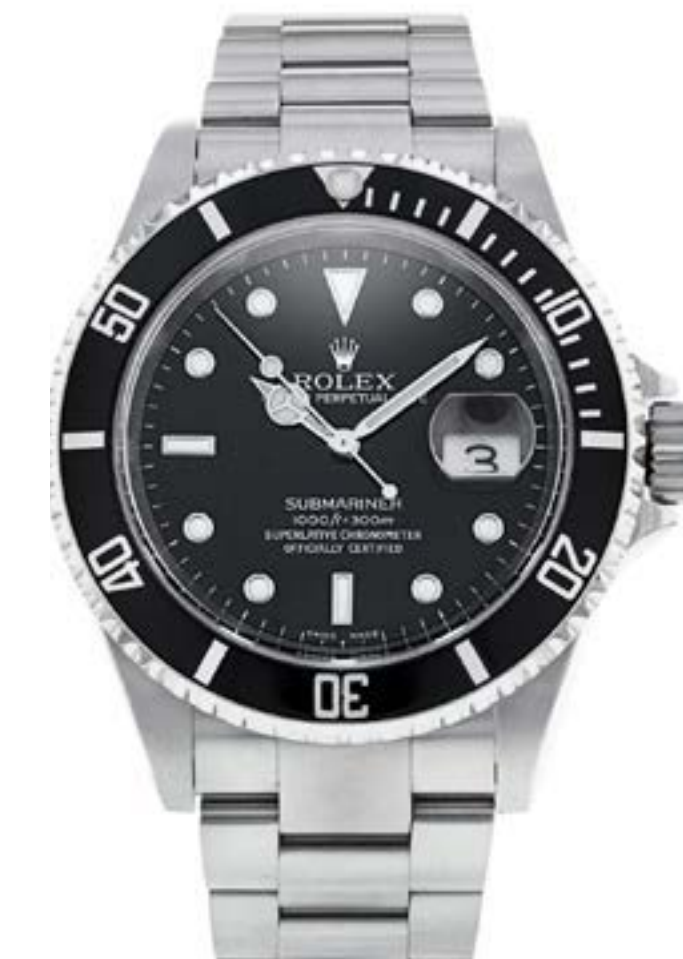

OBARRIO



REF. 16610



SUBMARINER DATE

-  Acero
-  40 mm
-  Automático

PRECIO 
\$12,000



CDE



REF. 16610

AIR KING	DAYTONA	DATEJUST	DAY-DATE	EXPLORER	GMT-MASTER	MILGAUSS
OYSTER PERPETUAL	SEA-DWELLER	SKY-DWELLER	SUBMARINER	YACHT-MASTER	CELLINI	

SUBMARINER
DATE

- Acero
- 40 mm
- Automático



PRECIO \$
\$10,500

- OBARRIO
- PAPELESCAJA

REF. 16610

SUBMARINER
NO DATE

- Acero
- 40 mm
- Automático



PRECIO \$
\$13,000

- OBARRIO

REF. 5512

SUBMARINER
DATE

- Acero
- 40 mm
- Automático



PRECIO \$
\$12,800

- OBARRIO

REF. 1680

SUBMARINER
NO DATE

- Acero
- 40 mm
- Automático



PRECIO \$
\$16,000

- OBARRIO

REF. 5513

SUBMARINER
DATE

- Acero
- 40 mm
- Automático



PRECIO \$
\$16,500

- OBARRIO

REF. 1680

SUBMARINER
NO DATE

- Acero
- 40 mm
- Automático



PRECIO \$
\$8,500

- OBARRIO

REF. 14060

AIR KING	DAYTONA	DATEJUST	DAY-DATE	EXPLORER	GMT-MASTER	MILGAUSS
OYSTER PERPETUAL	SEA-DWELLER	SKY-DWELLER	SUBMARINER	YACHT-MASTER	CELLINI	

SUBMARINER
NO DATE

- Acero
- 40 mm
- Automático

PRECIO 
\$10,000



OBARRIO



REF. 14060M

SUBMARINER
NO DATE

- Acero
- 40 mm
- Automático

PRECIO 
\$11,500



OBARRIO



REF. 114060

SUBMARINER
DATE

- Acero
- 40 mm
- Automático

PRECIO 
\$13,800



OBARRIO



PAPELESCAJA



REF. 116610

SUBMARINER
DATE

- Acero
- 40 mm
- Automático

PRECIO 
\$13,500



OBARRIO



PAPELESCAJA





REF. 116610



AIR KING	DAYTONA	DATEJUST	DAY-DATE	EXPLORER	GMT-MASTER	MILGAUSS
OYSTER PERPETUAL	SEA-DWELLER	SKY-DWELLER	SUBMARINER	YACHT-MASTER	CELLINI	

SUBMARINER DATE

-  Acero
-  40 mm
-  Automático



PRECIO 
\$13,800

-  OBARRIO
-  PAPELESCAJA



REF. 116610

SUBMARINER NO DATE

-  Acero
-  40 mm
-  Automático

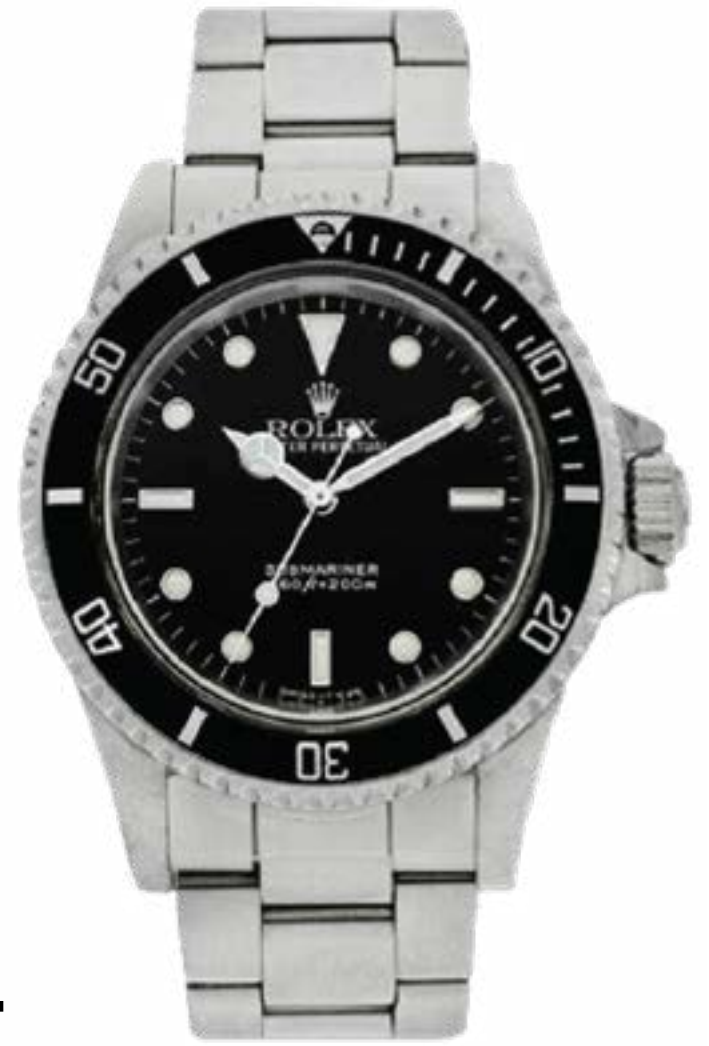

PRECIO 
\$10,000

-  CDE



REF. 5513

SUBMARINER DATE

-  Acero
-  40 mm
-  Automático



PRECIO 
\$12,800

-  OBARRIO
-  CAJA



REF. 116610

SUBMARINER NO DATE

-  Acero
-  40 mm
-  Automático

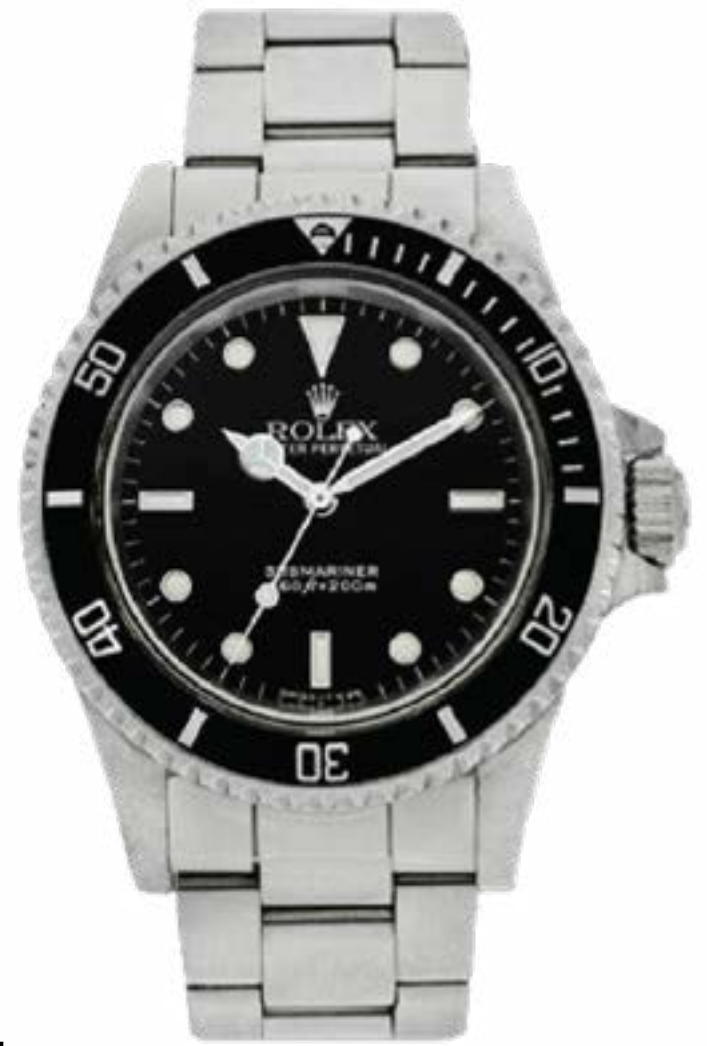

PRECIO 
\$15,000

-  CDE



REF. 5513

SUBMARINER DATE

-  Acero
-  40 mm
-  Automático



PRECIO 
\$13,000

-  OBARRIO



REF. 116610

SUBMARINER DATE

-  Acero
-  40 mm
-  Automático

PRECIO 
\$13,500

-  OBARRIO
-  CAJA PAPELES



REF. 116610

AIR KING	DAYTONA	DATEJUST	DAY-DATE	EXPLORER	GMT-MASTER	MILGAUSS
OYSTER PERPETUAL	SEA-DWELLER	SKY-DWELLER	SUBMARINER	YACHT-MASTER	CELLINI	

SUBMARINER
DATE

- Acero
- 40 mm
- Automático

PRECIO 
\$9,800



OBARRIO



REF. 16610



SUBMARINER
DATE

- Acero
- 40 mm
- Automático

PRECIO 
\$10,000



OBARRIO



CAJA



REF. 16610



SUBMARINER

- Acero
- 40 mm
- Automático

PRECIO 
\$10,800



CDE



PAPELESCAJA



REF. 16610

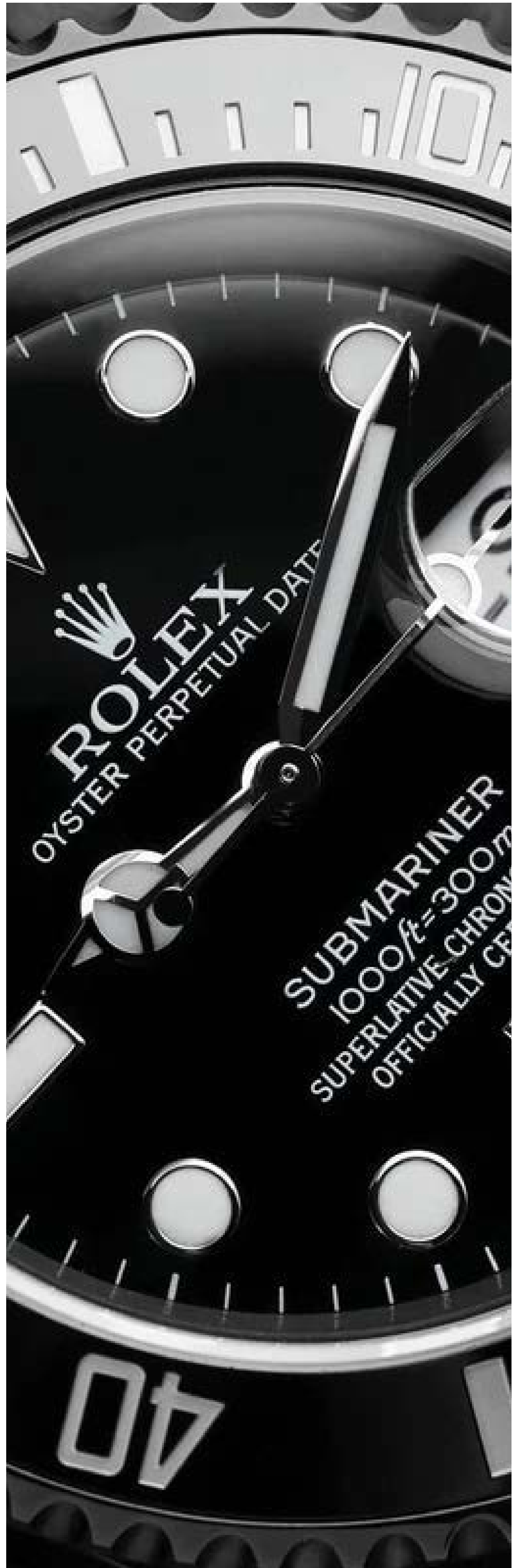

AIR KING	DAYTONA	DATEJUST	DAY-DATE	EXPLORER	GMT-MASTER	MILGAUSS
OYSTER PERPETUAL	SEA-DWELLER	SKY-DWELLER	SUBMARINER	YACHT-MASTER	CELLINI	

SUBMARINER



REF. 16613

- Acero / Oro
- 40 mm
- Automático

PRECIO \$12,500



SUBMARINER



REF. 16613

- Acero / Oro
- 40 mm
- Automático

PRECIO \$13,000



SUBMARINER

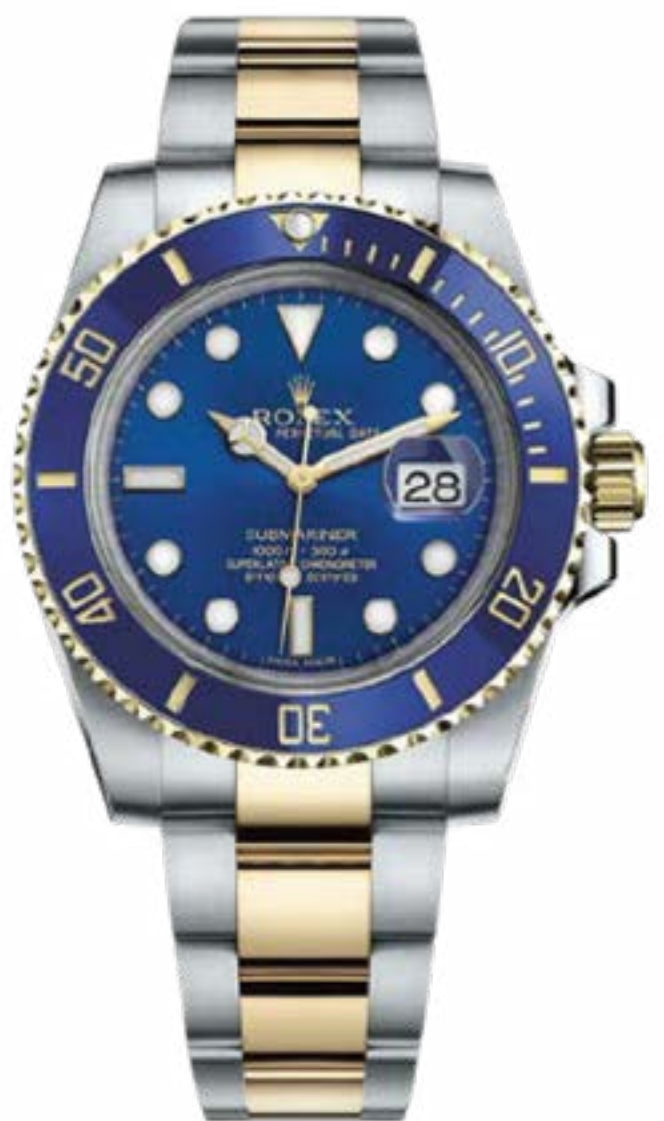

REF. 116613

- Acero / Oro
- 40 mm
- Automático

PRECIO \$15,500



SUBMARINER



REF. 16613

- Acero / Oro
- 40 mm
- Automático

PRECIO \$13,000



SUBMARINER



REF. 16613

- Acero / Oro
- 40 mm
- Automático

PRECIO \$12,500



SUBMARINER



REF. 16803

- Acero / Oro
- 40 mm
- Automático

PRECIO \$11,000



AIR KING	DAYTONA	DATEJUST	DAY-DATE	EXPLORER	GMT-MASTER	MILGAUSS
OYSTER PERPETUAL	SEA-DWELLER	SKY-DWELLER	SUBMARINER	YACHT-MASTER	CELLINI	

SUBMARINER



- Acero / Oro
- 40 mm
- Automático

PRECIO \$13,000



CDE

REF. 16613

SUBMARINER



- Oro
- 40 mm
- Automático

PRECIO \$30,500



OBARRIO

REF. 6618T

SUBMARINER



- Acero / Oro
- 40 mm
- Automático

PRECIO \$12,500



OBARRIO

REF. 16613

SUBMARINER



- Acero / Oro
- 40 mm
- Automático

PRECIO \$12,500



OBARRIO



PAPELESCAJA

REF. 16613

SUBMARINER



- Acero / Oro
- 40 mm
- Automático

PRECIO \$13,000



CDE

REF. 16613

SUBMARINER



- Acero / Oro
- 40 mm
- Automático

PRECIO \$16,800



OBARRIO





PAPELESCAJA

REF. 116613

AIR KING	DAYTONA	DATEJUST	DAY-DATE	EXPLORER	GMT-MASTER	MILGAUSS
OYSTER PERPETUAL	SEA-DWELLER	SKY-DWELLER	SUBMARINER	YACHT-MASTER	CELLINI	

SUBMARINER



-  Oro
-  40 mm
-  Automático

PRECIO 
\$38,000



-  OBARRIO
-  PAPELESCAJA

REF. 116618LN

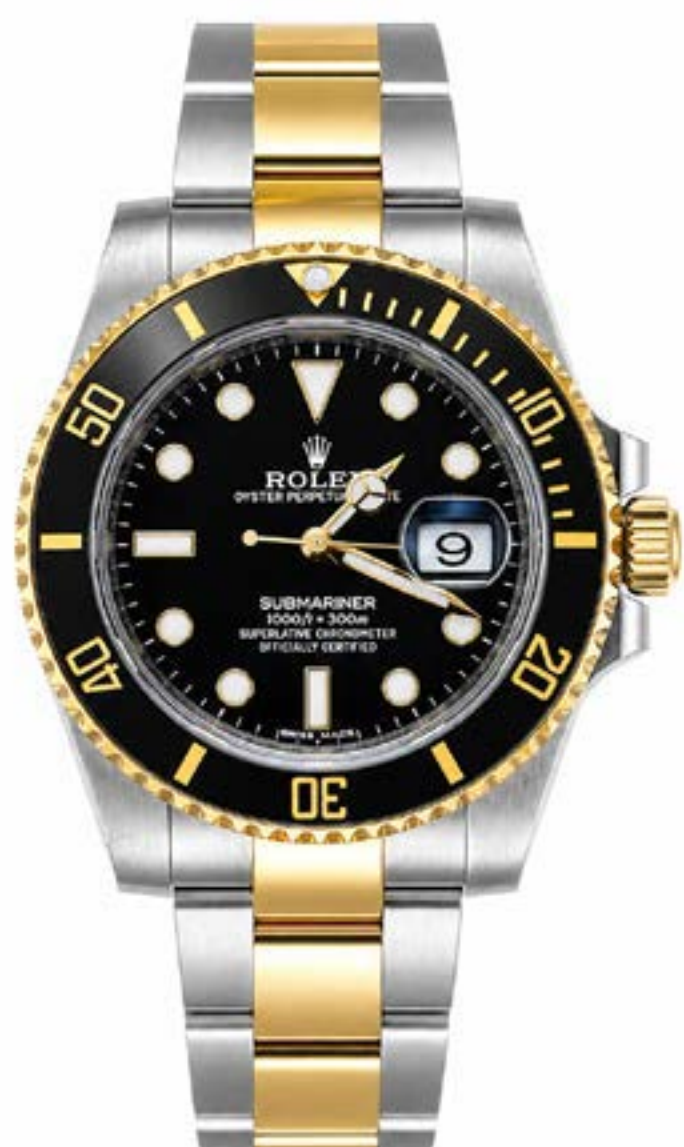

SUBMARINER



-  Acero / Oro
-  40 mm
-  Automático

PRECIO 
\$16,500



-  OBARRIO
-  PAPELESCAJA

REF. 116613

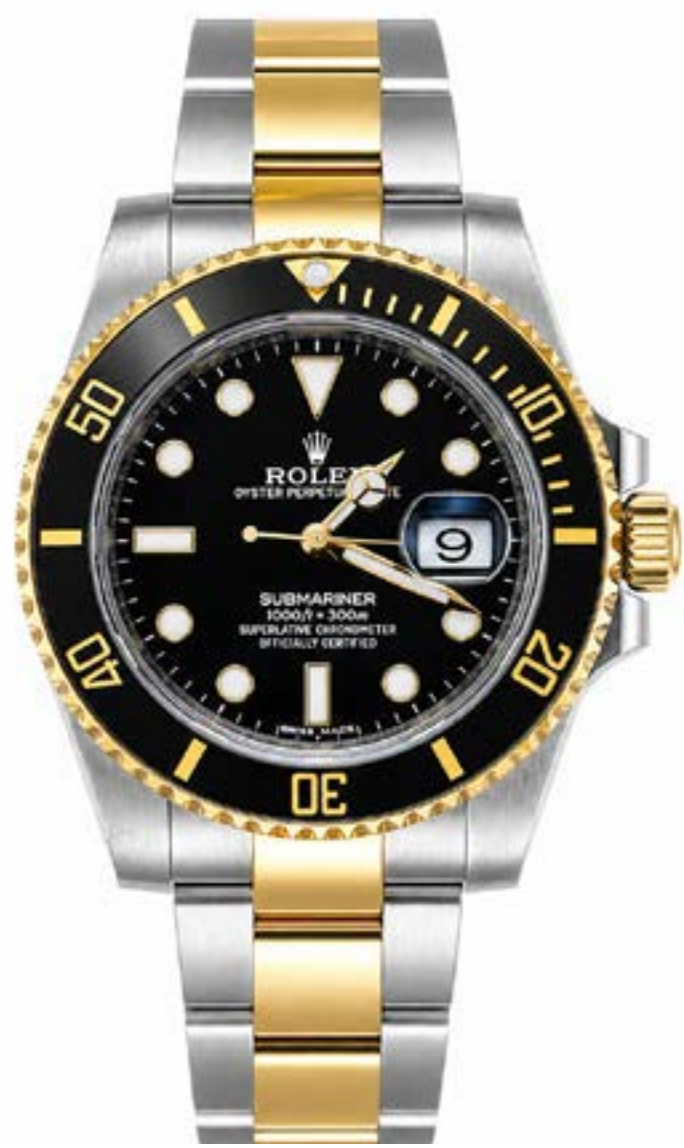

SUBMARINER



-  Acero / Oro
-  40 mm
-  Automático

PRECIO 
\$16,500



-  OBARRIO
-  PAPELESCAJA

REF. 116613



AIR KING	DAYTONA	DATEJUST	DAY-DATE	EXPLORER	GMT-MASTER	MILGAUSS
OYSTER PERPETUAL	SEA-DWELLER	SKY-DWELLER	SUBMARINER	YACHT-MASTER	CELLINI	

SUBMARINER
"SMURF"

-  Oro Blanco
-  40 mm
-  Automático

PRECIO 
\$38,500



OBARRIO



REF. 116619

"SMURF"



Su distintiva esfera azul intensa y el bisel cerámico Cerachrom a juego le dan una estética única que recuerda a las profundidades marinas, de donde proviene su apodo Smurf (Pitufo).

Equipado con el legendario calibre automático 3135 - reconocido por su fiabilidad, precisión y movimiento certificado como cronómetro - este reloj ofrece función de fecha, resistencia al agua hasta 300 m y un diseño robusto pero elegante, ideal tanto para el buceo profesional como para la muñeca de un coleccionista exigente.

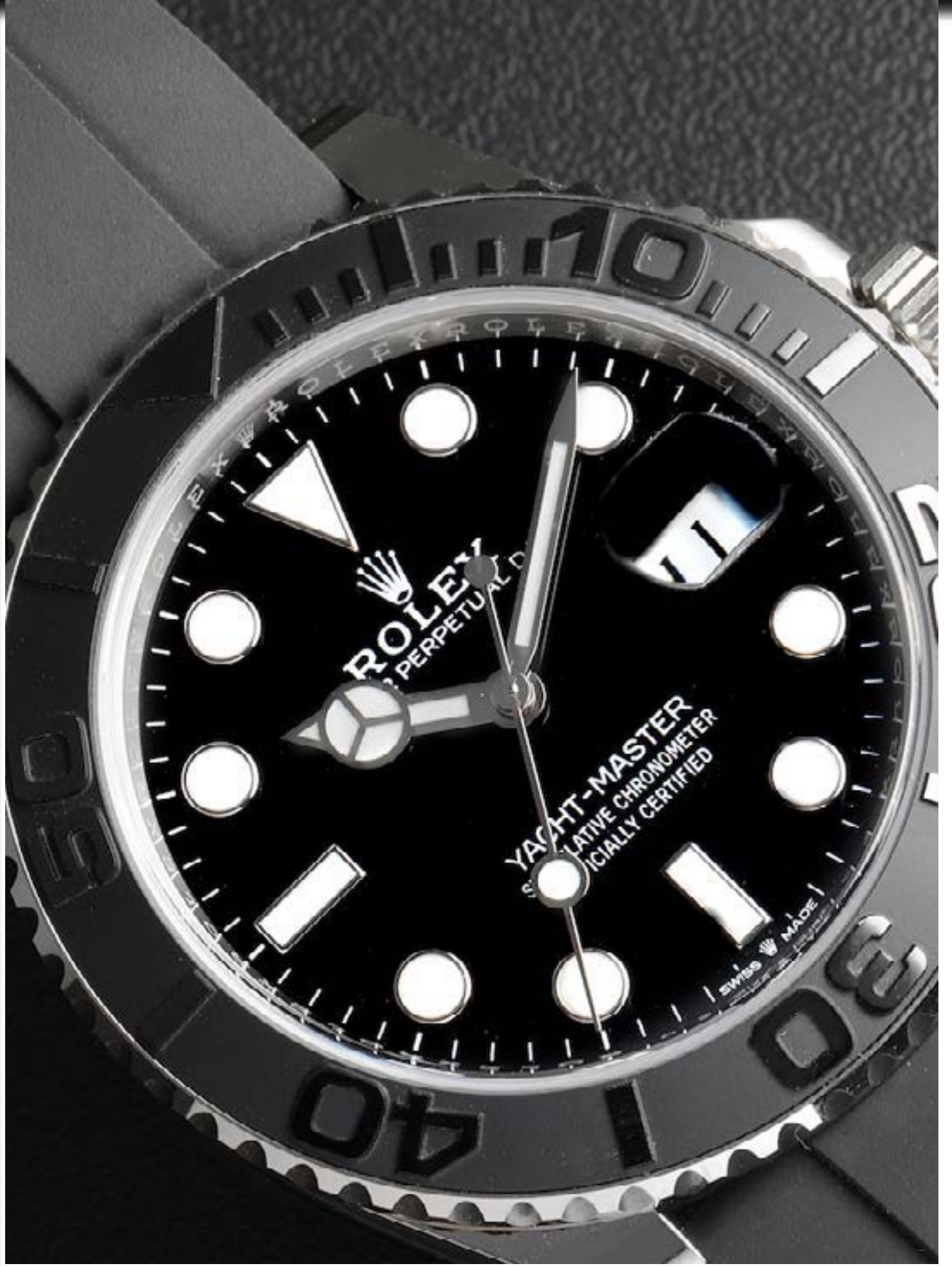

YACHT-MASTER II



-  Oro Blanco
-  42 mm
-  Automático

PRECIO 
\$32,000

REF. 226659

OBARRIO

CAJA

PAPELES



YACHT-MASTER II



OBARRIO



 Acero / Oro Rosa

 44 mm

 Automático

PRECIO 

\$23,000



REF. 116681



CAJA

AIR KING	DAYTONA	DATEJUST	DAY-DATE	EXPLORER	GMT-MASTER	MILGAUSS
OYSTER PERPETUAL	SEA-DWELLER	SKY-DWELLER	SUBMARINER	YACHT-MASTER	CELLINI	

YACHT-MASTER



-  Acero / Oro
-  40 mm
-  Automático

PRECIO 
\$13,500



REF. 16623

YACHT-MASTER

-  Acero / Oro
-  40 mm
-  Automático

PRECIO 
\$13,800





REF. 16623



YACHT-MASTER

"SERTI DIAL"

-  Oro
-  40 mm
-  Automático



PRECIO 
\$28,000



REF. 16628

YACHT-MASTER

"SERTI DIAL"

-  Oro Amarillo 18 k
-  35 mm
-  Automático

PRECIO 
\$20,000





REF. 168628



YACHT-MASTER

"TAHITIAN DIAL"



-  Oro
-  40 mm
-  Automático

PRECIO 
\$35,000



REF. 16628

YACHT-MASTER

-  Acero / Oro
-  40 mm
-  Automático



PRECIO 
\$13,800



REF. 168623

AIR KING	DAYTONA	DATEJUST	DAY-DATE	EXPLORER	GMT-MASTER	MILGAUSS
OYSTER PERPETUAL	SEA-DWELLER	SKY-DWELLER	SUBMARINER	YACHT-MASTER	CELLINI	

YACHT-MASTER II

-  Acero / Oro Rosa
-  44 mm
-  Automático

PRECIO 
\$24,500





CDE



REF. 116681

YACHT-MASTER II

-  Acero / Oro Rosa
-  44 mm
-  Automático

PRECIO 
\$22,500





OBARRIO



REF. 116681

YACHT-MASTER II

-  Acero / Oro Rosa
-  44 mm
-  Automático

PRECIO 
\$22,500





OBARRIO



REF. 116681

YACHT-MASTER II "CANAL DE PANAMÁ"

"EDICIÓN LIMITADA" 150 PIEZAS

-  Acero
-  44 mm
-  Automático

PRECIO 
\$25,000





CDE



REF. 116680

YACHT-MASTER II

-  Acero / Oro Rosa
-  44 mm
-  Automático

PRECIO 
\$22,500





OBARRIO



REF. 116681

YACHT-MASTER II "CANAL DE PANAMÁ"

"EDICIÓN LIMITADA" 150 PIEZAS

-  Acero
-  44 mm
-  Automático

PRECIO 
\$23,500



OBARRIO

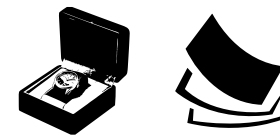



CAJA PAPELES





REF. 116680

AIR KING	DAYTONA	DATEJUST	DAY-DATE	EXPLORER	GMT-MASTER	MILGAUSS
OYSTER PERPETUAL	SEA-DWELLER	SKY-DWELLER	SUBMARINER	YACHT-MASTER	CELLINI	

YACHT-MASTER II

-  Acero
-  44 mm
-  Automático



PRECIO 
\$19,500

-  OBARRIO
-  PAPELESCAJA



REF. 116680

YACHT-MASTER II

-  Acero
-  44 mm
-  Automático

PRECIO 
\$19,000



-  OBARRIO



REF. 116680



YACHT-MASTER

-  Oro Blanco
-  44 mm
-  Automático



PRECIO 
\$36,000

-  OBARRIO
-  CAJA



REF. 116689

YACHT-MASTER II

-  Oro Blanco
-  44 mm
-  Automático

PRECIO 
\$38,000



-  OBARRIO
-  PAPELESCAJA



REF. 116689



YACHT-MASTER II

-  Oro Amarillo
-  44 mm
-  Automático

PRECIO 
\$44,500



-  OBARRIO
-  PAPELESCAJA



REF. 116688

AIR KING	DAYTONA	DATEJUST	DAY-DATE	EXPLORER	GMT-MASTER	MILGAUSS
OYSTER PERPETUAL	SEA-DWELLER	SKY-DWELLER	SUBMARINER	YACHT-MASTER	CELLINI	

YACHT-MASTER

-  Acero
-  40 mm
-  Automático

PRECIO 
\$9,800





CDE



REF. 16622



YACHT-MASTER

-  Acero
-  40 mm
-  Automático

PRECIO 
\$12,500



OBARRIO





PAPELESCAJA



REF. 16622



YACHT-MASTER

-  Acero
-  40 mm
-  Automático

PRECIO 
\$13,000



OBARRIO

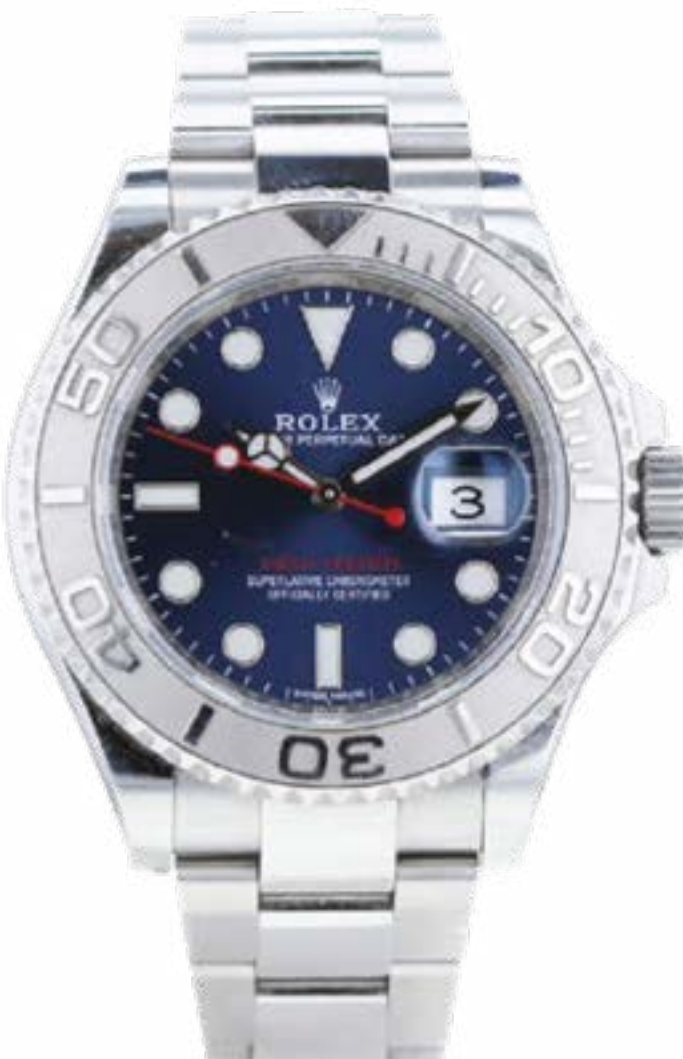

REF. 16622

AIR KING	DAYTONA	DATEJUST	DAY-DATE	EXPLORER	GMT-MASTER	MILGAUSS
OYSTER PERPETUAL	SEA-DWELLER	SKY-DWELLER	SUBMARINER	YACHT-MASTER	CELLINI	

CELLINI

SERPICO Y LAINO

"VINTAGE"

-  Oro
-  32 mm
-  Cuerda Manual

PRECIO 
\$5,000



REF. 8940

CELLINI

-  Oro Blanco
-  39 mm
-  Cuerda Manual

PRECIO 
\$13,000



REF. 50509

CELLINI

GENEVE



-  Oro Blanco
-  37 mm
-  Quartz

PRECIO 
\$16,500



REF. 6623

CELLINI



-  Oro blanco
-  32 mm
-  Automático

PRECIO 
\$5,500



REF. 5116

CELLINI

-  Oro Amarillo
-  25 mm
-  Quartz



PRECIO 
\$20,000



REF. 5218

PRECISION

VINTAGE

-  Acero/Oro/Diamantes
-  16 mm
-  Quartz

PRECIO 
\$12,800



REF. VINTAGE

AIR KING	DAYTONA	DATEJUST	DAY-DATE	EXPLORER	GMT-MASTER	MILGAUSS
OYSTER PERPETUAL	SEA-DWELLER	SKY-DWELLER	SUBMARINER	YACHT-MASTER	CELLINI	

ORCHID

 Oro / Diamantes

 19 x 24 mm

 Cuerda Manual

PRECIO 

\$8,200



OBARRIO



PAPELESCAJA



REF.

ORCHID





TAGHeuer
SWISS AVANT-GARDE SINCE 1860

Destacada por su precisión, innovación y estrecha relación con el automovilismo, TAG Heuer es una reconocida casa suiza de alta relojería, sus colecciones icónicas, como Carrera y Monaco, reflejan un enfoque técnico orientado al rendimiento y la medición del tiempo.

A lo largo de su historia, la marca ha impulsado avances en cronografía y diseño deportivo, consolidándose como un referente en relojería contemporánea.

AARON  JOYEROS



TAGHeuer
SWISS AVANT-GARDE SINCE 1860

AQUARACER

- Acero
- 43 mm
- Automático

PRECIO
\$1,800



OBARRIO



REF. CAK2110.BA0833





TAGHeuer
SWISS AVANT-GARDE SINCE 1860



ÍNDICE

AQUARACER	CARRERA	FÓRMULA	LINK	MONZA	MÓNACO
MOP DIAMOND	CHRONOMETER	PROFESSIONAL			



 Acero / Oro

 43 mm

 Automático

REF.

PRECIO 

\$2,600

AQUARACER



TAGHeuer
SWISS AVANT-GARDE SINCE 1860



ÍNDICE

AQUARACER	CARRERA	FÓRMULA	LINK	MONZA	MÓNACO
MOP DIAMOND	CHRONOMETER	PROFESSIONAL			

AQUARACER

Acero y Oro

27 mm

Quartz

PRECIO

\$850



OBARRIO



REF. WAF1420



AQUARACER

Acero

43 mm

Quartz

PRECIO

\$1,200



OBARRIO



REF. CAY1110.BA0927





TAGHeuer

SWISS AVANT-GARDE SINCE 1860

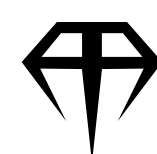

ÍNDICE

AQUARACER	CARRERA	FÓRMULA	LINK	MONZA	MÓNACO
MOP DIAMOND	CHRONOMETER	PROFESSIONAL			

CARRERA

Acero

39 mm

Automático

PRECIO
2,300

REF WBN2112.BA0639



CAJA



PAPELES



CDE





TAGHeuer
SWISS AVANT-GARDE SINCE 1860



ÍNDICE

AQUARACER	CARRERA	FÓRMULA	LINK	MONZA	MÓNACO
MOP DIAMOND	CHRONOMETER	PROFESSIONAL			

CARRERA TITAN



OBARRIO

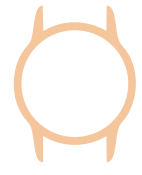

Titanio y Oro



45 mm



Automático

PRECIO 
\$5,400



TAGHeuer
SWISS AVANT-GARDE SINCE 1860

REF.

CAR2A5A.FT6044



TAGHeuer
SWISS AVANT-GARDE SINCE 1860

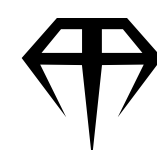

ÍNDICE

AQUARACER	CARRERA	FÓRMULA	LINK	MONZA	MÓNACO
MOP DIAMOND	CHRONOMETER	PROFESSIONAL			

CARRERA



- Acero / Oro
- 41 mm
- Automático

PRECIO \$3,000

OBARRIO

REF CV2050-1

REF



TAG Heuer
SWISS AVANT-GARDE SINCE 1860

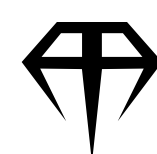

ÍNDICE

AQUARACER	CARRERA	FÓRMULA	LINK	MONZA	MÓNACO
MOP DIAMOND	CHRONOMETER	PROFESSIONAL			

CARRERA



REF. CAR2014.FC6235

- Acero
- 43 mm
- Automático

PRECIO
\$2,200

- OBARRIO
- PAPELESCAJA

GRAND CARRERA CHRONOGRAPH



REF. CAV518B

- Acero
- 43 mm
- Automático

PRECIO
\$3,600

- OBARRIO

CARRERA

"Skeleton Black Dial"



REF. CAR201V.FT6087

- Acero
- 43 mm
- Automático

PRECIO
\$3,000

- OBARRIO
- PAPELES

CARRERA



REF. WAR5010.BA0723

- Acero
- 41 mm
- Automático

PRECIO
\$2,200

- OBARRIO
- PAPELES

CARRERA



REF. WBN2010

- Acero
- 41 mm
- Automático

PRECIO
\$3,000

- OBARRIO
- PAPELESCAJA

CARRERA CALIBRE 8 GMT



REF. WAR5010.BA0723

- Acero
- 41 mm
- Automático

PRECIO
\$2,300

- OBARRIO



TAG Heuer
SWISS AVANT-GARDE SINCE 1860

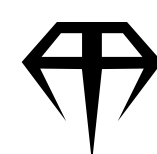

ÍNDICE

AQUARACER	CARRERA	FÓRMULA	LINK	MONZA	MÓNACO
MOP DIAMOND	CHRONOMETER	PROFESSIONAL			

CARRERA CHRONOGRAPH

- Acero
- 42 mm
- Automático

PRECIO

\$3,800



OBARRIO



REF. OBN2010

GRAND CARRERA

- Acero
- 42.5 mm
- Automático

PRECIO

\$2,350



CDE



REF. WAV5112.BA0901

CARRERA

- Acero
- 41 mm
- Automático

PRECIO

\$3,000



OBARRIO



PAPELESCAJA



REF. WBN2013.FC6503

CARRERA

- Acero
- 41 mm
- Automático

PRECIO

\$2,200



OBARRIO



REF. WBN2013.FC6503

CARRERA

- Acero
- 39 mm
- Automático

PRECIO

\$1,800



OBARRIO



REF. WAS2112.FC6181

CARRERA

- Acero
- 43 mm
- Automático

PRECIO

\$3,200



OBARRIO



REF. CAR2A80



TAGHeuer
SWISS AVANT-GARDE SINCE 1860



FÓRMULA 1



REF. CAZ101N.FC8243

-  Acero
-  43 mm
-  Quartz

PRECIO 
\$1,500

AARON  JOYEROS



TAGHeuer
SWISS AVANT-GARDE SINCE 1860



WBY1111.BA0042



Acero



38 mm



Quartz

PRECIO



\$1,550



PAPELESCAJA



OBARRIO

FÓRMULA 1 SOLARGRAPH

AARON  JOYEROS



TAGHeuer
SWISS AVANT-GARDE SINCE 1860



ÍNDICE

AQUARACER	CARRERA	FÓRMULA	LINK	MONZA	MÓNACO
MOP DIAMOND	CHRONOMETER	PROFESSIONAL			



FÓRMULA 1

REF CAH1111.BA0850

-  Acero
-  41 mm
-  Quartz

PRECIO 
\$1,300



TAG Heuer
SWISS AVANT-GARDE SINCE 1860

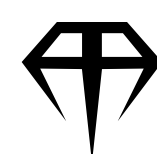

ÍNDICE

AQUARACER	CARRERA	FÓRMULA	LINK	MONZA	MÓNACO
MOP DIAMOND	CHRONOMETER	PROFESSIONAL			

FÓRMULA 1 LADY

- Acero/Diamantes
- 37 mm
- Quartz

PRECIO
\$2,100



OBARRIO



REF. WAC1218.BA0852

FÓRMULA 1

- Acero y Cerámica
- 41 mm
- Automático

PRECIO
\$1,400



OBARRIO



REF. CAH1213

FÓRMULA 1

- Acero/Diamantes
- 37 mm
- Automático

PRECIO
\$2,500



OBARRIO



PAPELESCAJA



REF. WAU2213

FÓRMULA 1 DAVID GUETTA

- Acero / Cuero
- 43 mm
- Automático

PRECIO
\$2,000



OBARRIO



CAJA



REF. WAZ201A

FÓRMULA 1 - LADY

- Acero
- 36 mm
- Quartz

PRECIO
\$2,000



OBARRIO



REF. WAC1216-0



TAGHeuer
SWISS AVANT-GARDE SINCE 1860

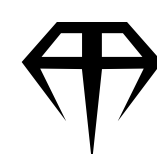

ÍNDICE

AQUARACER	CARRERA	FÓRMULA	LINK	MONZA	MÓNACO
MOP DIAMOND	CHRONOMETER	PROFESSIONAL			



LINK

CALIBRE

- Acero
- 42 mm
- Automático

PRECIO \$1,500



T2011.BA0951





TAG Heuer
SWISS AVANT-GARDE SINCE 1860

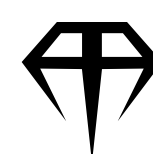

ÍNDICE

AQUARACER	CARRERA	FÓRMULA	LINK	MONZA	MÓNACO
MOP DIAMOND	CHRONOMETER	PROFESSIONAL			

MONZA

CALIBRE 17

Acero / Cerámica

42 mm

Automático

PRECIO

\$4,000



OBARRIO



REF. CR2080

MÓNACO

Acero / Cuero

41 mm

Automático

PRECIO

\$4,200



OBARRIO



REF. WW2114

MOP DIAMOND

"DIAL MADRE PERLA"

Acero

28 mm

Quartz

PRECIO

\$1,200



OBARRIO



REF. WP131C

CHRONOMETER

Acero

38 mm

Automático

PRECIO

\$900



OBARRIO



REF. WH5115-KT

PROFESSIONAL

Acero

37 mm

Quartz

PRECIO

\$600



OBARRIO



REF. WL1112.BA0701

PROFESSIONAL

Acero

37 mm

Quartz

PRECIO

\$950



OBARRIO



REF. WK1112



TIFFANY & Co.

Tiffany & Co. es una icónica casa de lujo reconocida por su elegancia atemporal y su legado en la alta joyería. En relojería, sus creaciones combinan diseño sofisticado con precisión, reflejando un estilo refinado y distintivo.

Tiffany & Co. representa exclusividad, buen gusto y tradición dentro del universo del lujo.

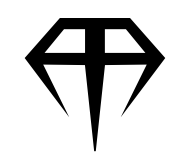

ATLAS DOME



OBARRIO



ACERO/CUERO

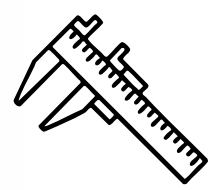

31 mm

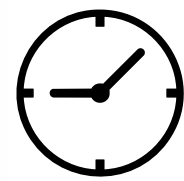

Quartz

PRECIO



\$1,500

REF.

Z1831.11.10B10A40A



TIFFANY & CO. CLASSIC

 Oro

 35 mm

 Automático

PRECIO 

\$5,000



OBARRIO



REF.

M253







T+
TISSOT

Tiffany & Co. es una icónica casa de lujo reconocida por su elegancia atemporal y su legado en la alta joyería. En relojería, sus creaciones combinan diseño sofisticado con precisión, reflejando un estilo refinado y distintivo.

Tiffany & Co. representa exclusividad, buen gusto y tradición dentro del universo del lujo.

AARON  JOYEROS

PRS 516

-  Acero
-  42 mm
-  Automático



PRECIO 
\$950



OBARRIO



CAJA

REF. **T100.430.16.051.00**





TUDOR

Tudor es una destacada casa suiza reconocida por ofrecer relojería de alto rendimiento con un enfoque robusto y accesible dentro del lujo. Sus modelos, inspirados en la herencia de su marca matriz, combinan fiabilidad, diseño deportivo y excelente relación calidad-precio.



Tudor representa resistencia, precisión y espíritu aventurero en la relojería contemporánea.

AARON  JOYEROS



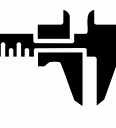

TUDOR

BLACK BAY

-  Cerámica y Acero
-  41 mm
-  Automático

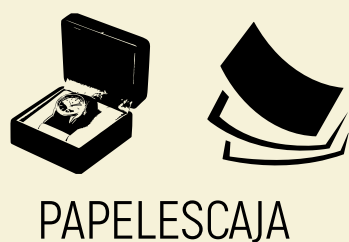
PRECIO 
\$3,850



PAPELESCAJA

REF. M79210CNU-0001



OBARRIO



AARON  JOYEROS

DOUBLE DATE



CAJA



PAPELES



Acero



42 mm



Automático



OBARRIO

REF.

M57100-0001

PRECIO 

\$3,000



U-BOAT

U-Boat es una firma italiana reconocida por su diseño audaz y de gran tamaño, inspirado en instrumentos militares y de buceo. Sus relojes destacan por cajas robustas, coronas distintivas y una estética vintage-industrial muy marcada.

U-Boat representa carácter, originalidad y una presencia contundente dentro de la relojería contemporánea.

CLASSICO



Acero

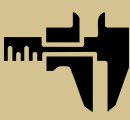

53 mm



Automático

PRECIO



\$1,800

REF.

55780



OBARRIO





ULYSSE NARDIN
SINCE 1846  LE LOCLE - SUISSE

Ulysse Nardin es una histórica manufactura suiza reconocida por su innovación técnica y su estrecha relación con la navegación marina. Sus relojes destacan por la precisión, el desarrollo de complicaciones y el uso de tecnologías avanzadas.

Ulysse Nardin representa tradición, ingeniería y espíritu explorador dentro de la alta relojería.

AARON  JOYEROS

MARINE

- Acero / Caucho
- 40 mm
- Automático

PRECIO 
\$4,000



REF. 263-33

SAN MARCO

- Acero
- 38.5 mm
- Automático

PRECIO 
\$3,000



REF. 433-77

MAXI MARINE

- Acero
- 41 mm
- Automático

PRECIO 
\$3,800



REF. 353-66-314

DIVER

- Acero
- 44 mm
- Automático

PRECIO 
\$7,000



REF. 1183-170-3/92



VACHERON CONSTANTIN

Vacheron Constantin es una de las manufacturas más antiguas y prestigiosas de la alta relojería, reconocida por su excelencia artesanal, precisión y tradición ininterrumpida. Sus creaciones destacan por el desarrollo de complicaciones y acabados de alto nivel.

Vacheron Constantin representa elegancia, maestría y herencia dentro del universo más exclusivo de la relojería.



OVERSEAS

ORO AMARILLO



37 mm

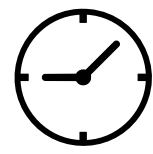

AUTOMÁTICO

PRECIO 
\$18,000



OBARRIO



REF. 2042/000J-8966



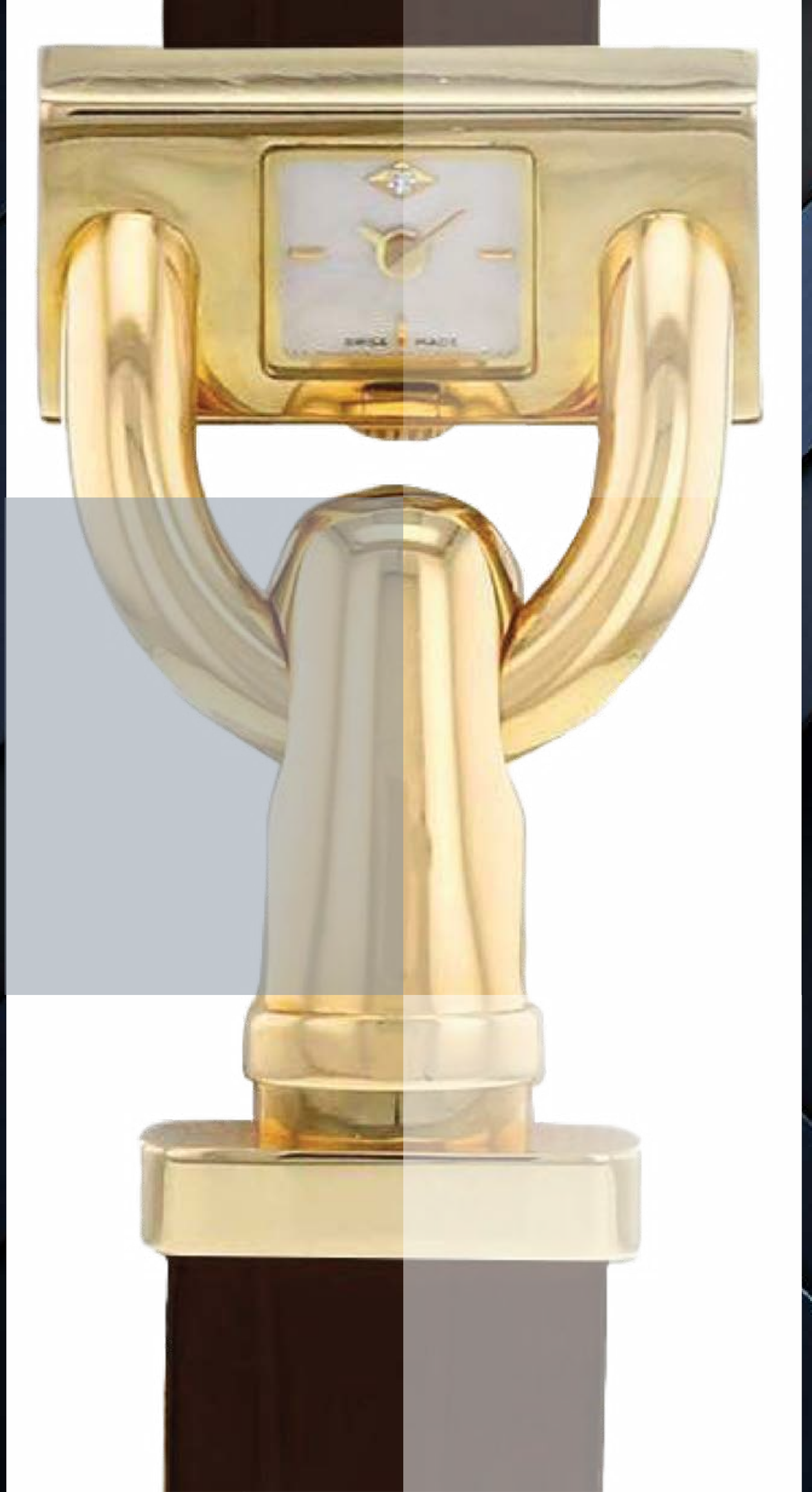

Van Cleef & Arpels

Chopard es una reconocida casa suiza que combina alta relojería y joyería con un enfoque en la elegancia, la innovación y la artesanía. Sus creaciones destacan por la atención al detalle y el uso de materiales de alta calidad.

A lo largo de su trayectoria, la marca ha desarrollado colecciones icónicas que equilibran técnica y estética, consolidando su presencia en el mundo del lujo. Chopard representa refinamiento, creatividad y excelencia dentro del universo relojero.



CÁRDENAS

 Oro Amarillo

 26 x 14 mm

 Quartz

PRECIO 
\$9,700

CDE



REF. 371505



Vintage

Esta selección de relojería vintage rinde tributo a la era dorada de la mecánica, donde la precisión y el arte se fusionaban en piezas de valor eterno. Estos ejemplares destacan por su manufactura artesanal en metales nobles y esferas de porcelana. Cada reloj de esta colección es un testimonio del ingenio humano, conservando la elegancia clásica que trasciende las modas pasajeras. Son joyas mecánicas que representan la máxima sofisticación de una época donde cada segundo se medía con distinción.

Vintage

WALTHAM

VINTAGE

Colección personal de Juan Vicente Gómez, representa la unión entre la precisión industrial y el poder político de principios del siglo XX. Con su esfera de porcelana blanca y caja de alta gama, esta pieza personifica la estética de sobriedad y mando que caracterizó al "Benemérito". Más que un instrumento para medir el tiempo, el ejemplar es un testigo patrimonial de la historia venezolana y de la fiabilidad técnica de una era dorada en la relojería norteamericana.

ORO 18k

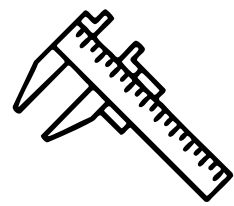

48 mm

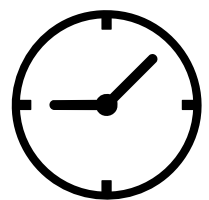

Cuerda manual

PRECIO 
\$20,000



REF.

VINTAGE



OBARRIO

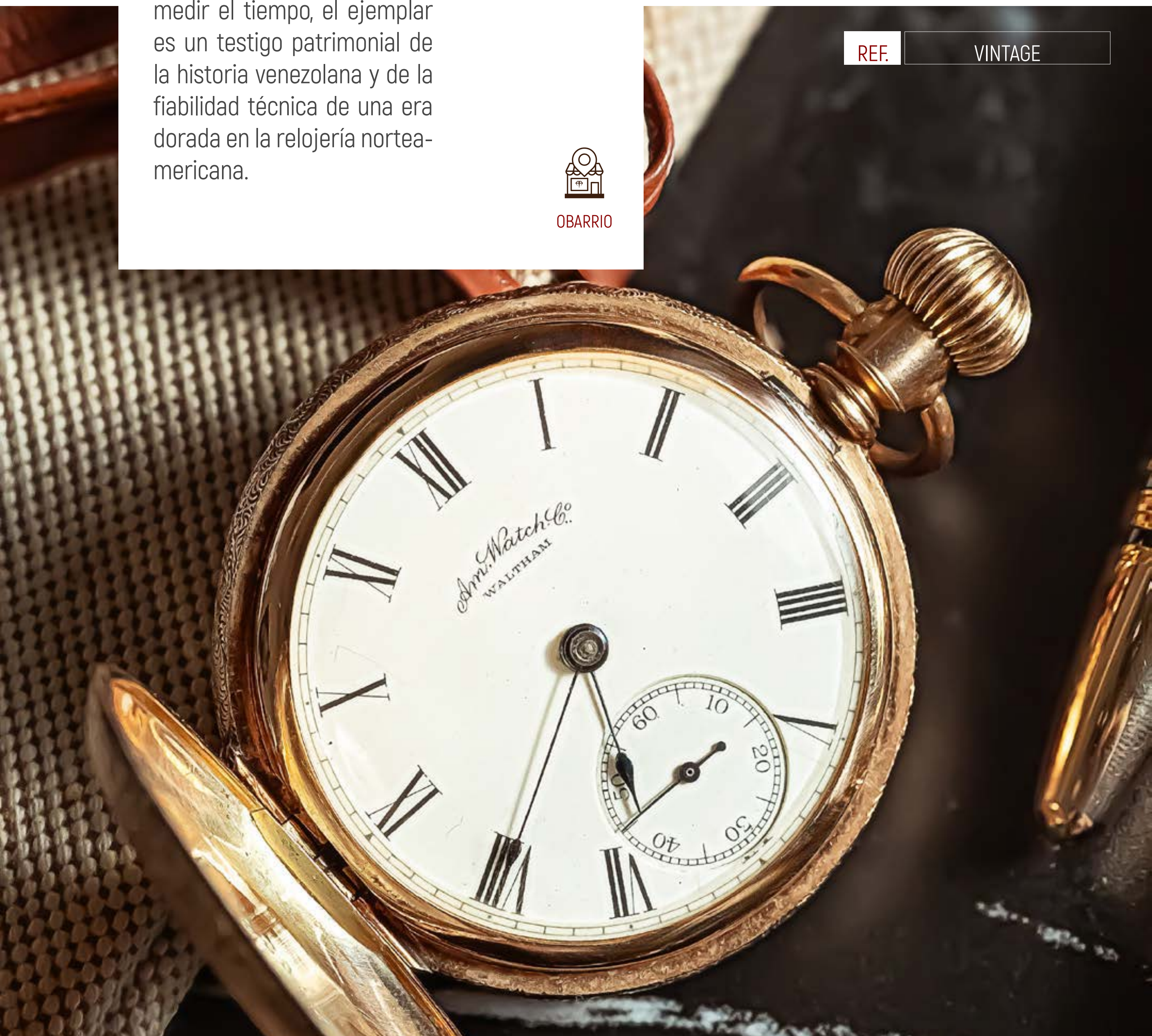

OMEGA VINTAGE

- Acero
- 41 mm
- Quartz

PRECIO 
\$1,500



OBARRIO



REF. VINTAGE

TUDOR VINTAGE

- Acero
- 17 mm
- Automático

PRECIO 
\$800



OBARRIO



REF. VINTAGE

PRECISION VINTAGE

- Acero/Oro/Diamantes
- 16 mm
- Quartz

PRECIO 
\$12,800



OBARRIO



REF. VINTAGE

OMEGA VINTAGE

"STRAP AFTER MARKET"

- Oro Rosa
- 36 mm
- Automático

PRECIO 
\$4,000



OBARRIO



REF. VINTAGE

OMEGA CONSTELLATION

- Oro Amarillo
- 35 mm
- Quartz

PRECIO 
\$4,000



OBARRIO



REF. 2652 SC

SEAMASTER DYNAMIC

"BISEL ORO"

- Acero
- 34 mm
- Quartz

PRECIO 
\$1,000



OBARRIO



REF. 96.0301 396.0993

PIAGET CUERVOS Y SOBRINOS

- Acero
- 32 mm
- Automático

PRECIO 
\$500



OBARRIO



REF. VINTAGE

LONGINES

- Oro
- 32 mm
- Quartz

PRECIO 
\$3,500



OBARRIO



CAJA



REF. 1940

SEAMASTER VINTAGE

- Oro Amarillo
- 34 mm
- Quartz

PRECIO 
\$3,500



OBARRIO



REF. VINTAGE

SEAMASTER 1970

"DIAL SPIDER"

- Acero
- 43 x 46 mm
- Automático

PRECIO 
\$9,000



OBARRIO



REF. 166.073

MUST VERMEIL 925

- Oro Amarillo
- 24 mm
- Quartz

PRECIO 
\$1,900



OBARRIO



REF. 590004

Diamantes

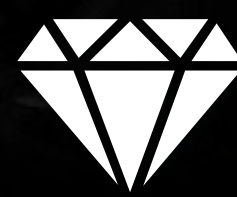

Presentamos una cuidada selección de diamantes elegidos bajo los más altos estándares de calidad, pureza y proporción. Cada piedra ha sido evaluada por su brillo, simetría y transparencia, garantizando una presencia que deslumbra a primera vista.

Nuestra colección equilibra corte, color, claridad y quilataje, asegurando no solo belleza excepcional, sino también valor y permanencia en el tiempo. Más que una muestra de gemas, es una invitación a invertir con criterio y crear piezas destinadas a trascender generaciones.

Aquí comienza su próxima gran elección.



DIAMANTES

01/02



REDONDO

CT 1.06
COLOR J/K
CLARIDAD VS2

PRECIO 
\$4,150

OBARRIO



REDONDO

CT 0.44
COLOR K/L
CLARIDAD SI1

PRECIO 
\$650

OBARRIO



REDONDO

CT 0.22
COLOR
CLARIDAD

PRECIO 
\$2,000

OBARRIO



REDONDO

 **GIA** 
CT 1.30 L, FAINT
COLOR BROWN VVS2
CLARIDAD

PRECIO 
\$3,300

OBARRIO



REDONDO

CT 1.20
COLOR
CLARIDAD

PRECIO 
\$3,800

OBARRIO



PRINCESS CUT

CT 1.60
COLOR H
CLARIDAD i2

PRECIO 
\$5,000

OBARRIO



DIAMANTES

02/02



REDONDO

CT 1.64
COLOR G
CLARIDAD VS2

PRECIO 
\$12,000

OBARRIO



RADIANT CUT

 GIA 

CT 2.19
COLOR F
CLARIDAD vvs1

PRECIO 
\$22,000

OBARRIO



REDONDO

CT 0.75
COLOR J
CLARIDAD VS11

PRECIO 
\$2,500

OBARRIO



REDONDO

CT 1.735
COLOR m
CLARIDAD si1

PRECIO 
\$3,500

OBARRIO



CUSHION CUT

CT 0.87
COLOR fancy
CLARIDAD yellow

PRECIO 
\$4,500

OBARRIO



CUSHION CUT

 GIA

CT 2.13
COLOR f
CLARIDAD vs1

PRECIO 
\$19,800

COSTA DEL ESTE



BOLÍGRAFOS

Una colección creada para quienes ven la escritura como una **expresión de estilo y personalidad**. Cada pieza combina precisión, equilibrio y diseño refinado para ofrecer una experiencia superior en cada trazo.

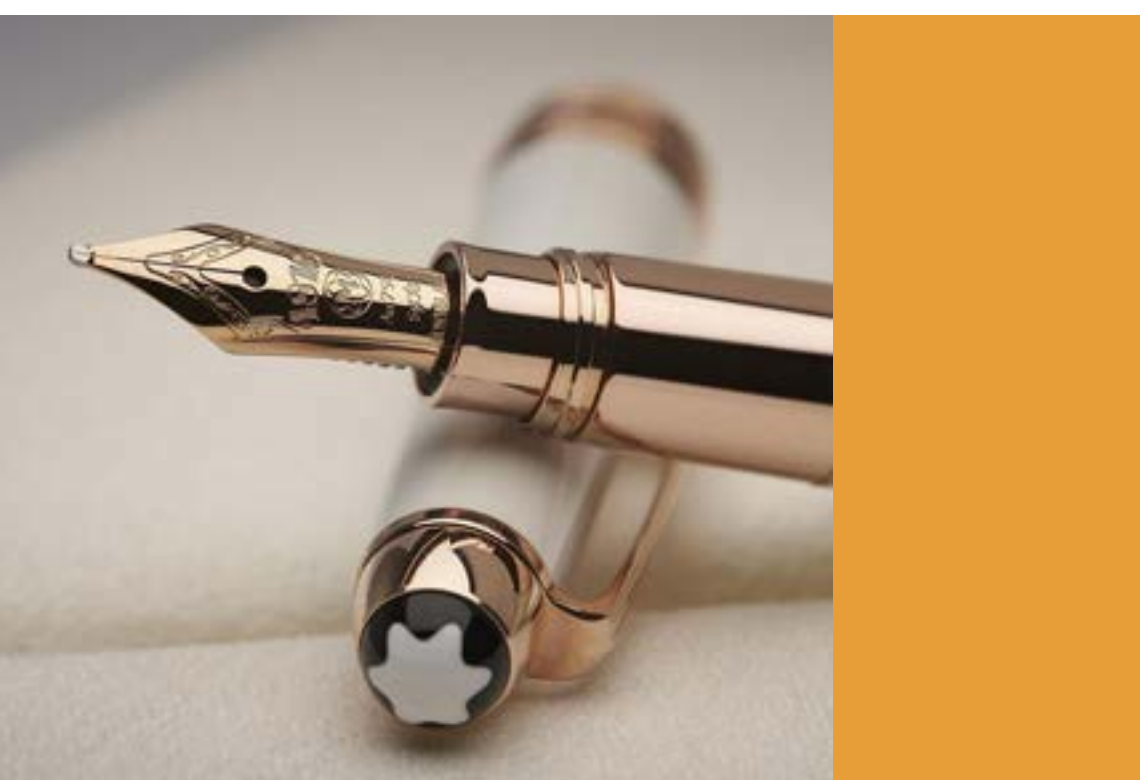

AARON  JOYEROS

HOMENAJE A

ROBERT LOUIS STEVENSON



**MONT
BLANC**

EDICIÓN LIMITADA



CAJA



PAPELES

PRECIO 
\$5,700



OBARRIO

BOLÍGRAFOS

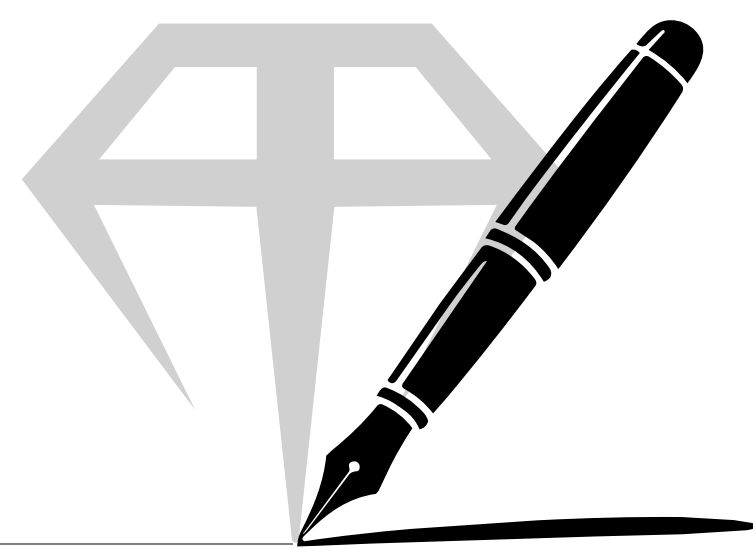

AARON  JOYEROS

BOLÍGRAFOS



MONT
BLANC



JOHN LENNON

TIPO | ROLLERBALL

PRECIO 
\$1,400



JOHN LENNON

TIPO | FUENTE

PRECIO 
\$1,400



BOLÍGRAFOS

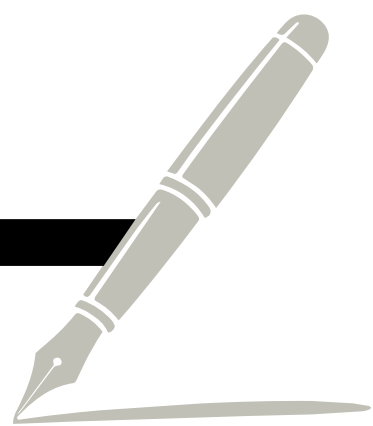

MONT
BLANC



MAHATMA GANDHI

TIPO | ESTILOGRÁFICA



PAPELESCAJA



PRECIO 
\$2,200



PRINCESSE

Grace de Mónaco

TIPO | ROLLERBALL

PRECIO 
\$600



CAJA



PAPELES

MONT
BLANC



AARON  JOYEROS



BOLÍGRAFOS

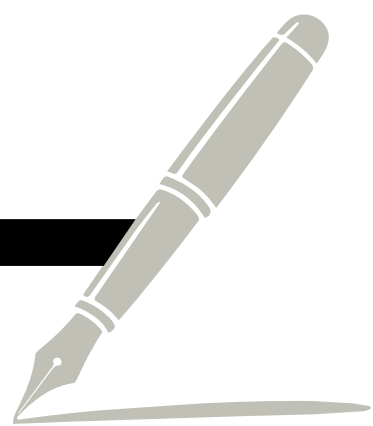

**MONT
BLANC**

HENRY E. STEINWAY

TIPO | ESTILOGRÁFICA



Mecenas del Arte
Steinway 4810

Esta pluma rinde homenaje a Henry E. Steinway, fundador de Steinway & Sons y revolucionario de la fabricación de pianos en el siglo XIX. Montblanc la incluyó en su colección Patron of Art, combinando inspiración musical con alta artesanía en escritura.

PRECIO 
\$3,000



PAPELESCAJA



AARON  JOYEROS

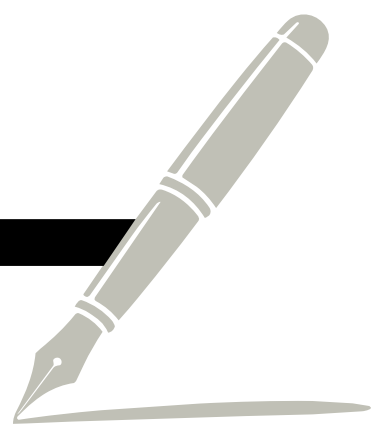

EDITION

LEO TOLSTOY

TIPO | BALLPOINT

PRECIO 
\$3,500



CAJA

EDITION LEO
TOLSTOY **TIPO** |
BALLPOINT

PRECIO
\$2,600



PAPELES

MONTBLANC 



BOLÍGRAFOS

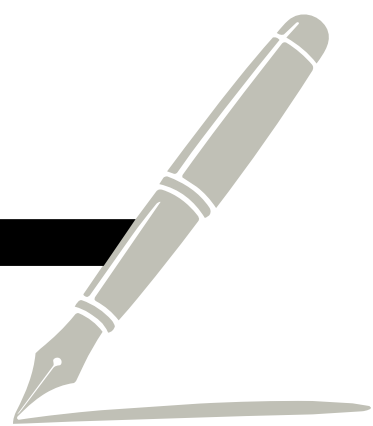

**MONT
BLANC** 

GEORGE BERNARD SHAW

EDICIÓN LIMITADA

TIPO | BALLPOINT



PAPELESCAJA



PRECIO 
\$1,500

EDICIÓN MEISTERSTÜCK

TIPO | ROLLERBALL

PRECIO 
\$700



AARON  JOYEROS

BOLÍGRAFOS



**MONT
BLANC** 



MEISTERSTÜCK

TIPO | BALLPOINT

PRECIO 
\$300

MEISTERSTÜCK



TIPO | RESALTADOR



CAJA

PRECIO 
\$220



AARON  JOYEROS

BOLÍGRAFOS

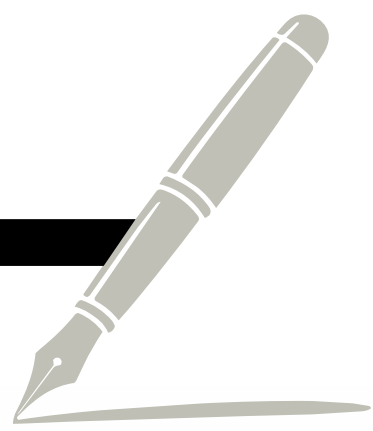

**MONT
BLANC**

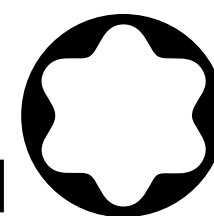

STARWALKER

TIPO | ESTILIGRÁFICA

PRECIO 
\$300



MEISTERSTÜCK

TIPO | BALLPOINT

PRECIO 
\$400



MEISTERSTÜCK

TIPO | BALLPOINT Solitaire Douè

PRECIO 
\$1,400



AARON  JOYEROS

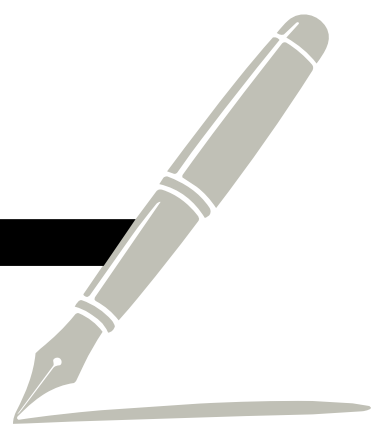

LE MUST PHANTERE

TIPO | ESTILIGRÁFICA

PRECIO 
\$1,200



DIABOLO



TIPO | BALLPOINT

PRECIO 
\$600



**MONT
BLANC** 

TIPO
Bohème
Rollerball

PRECIO 
\$650



WATERMAN
PARIS

TIPO
EDSON
FUENTE

PRECIO 
\$120



 **PILOT**

TIPO
BLACK
CARBONESQUE
FUENTE

PRECIO 
\$120



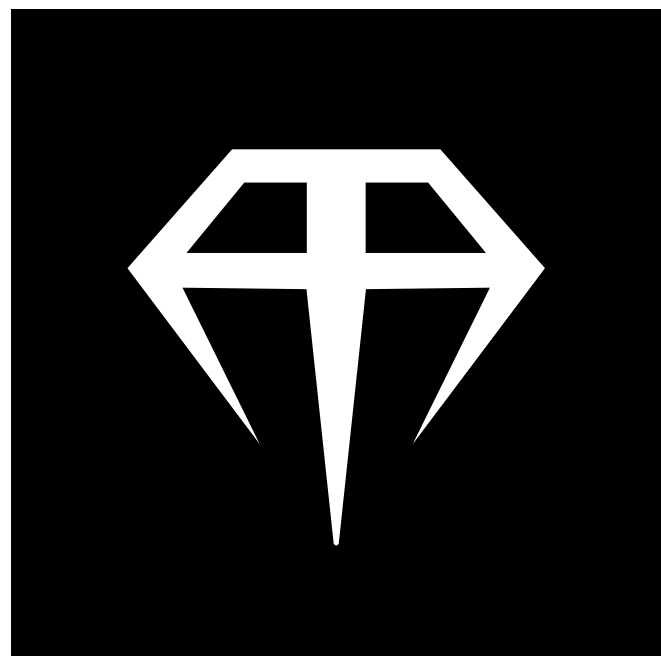

Mancuernas

01

Clásicos Atemporales

Siluetas pulidas y simétricas que celebran el buen vestir tradicional. La inversión definitiva en sutileza y distinción que nunca pasa de moda.

TIFFANY & Co.

ESPECIFICACIONES



Oro / 18 Quilates



OBARRIO

PRECIO

\$2,420



ESPECIFICACIONES



Oro / 14 Quilates



OBARRIO

PRECIO

\$3,100

ESPECIFICACIONES



Oro / 14 Quilates



OBARRIO

PRECIO

\$3,000



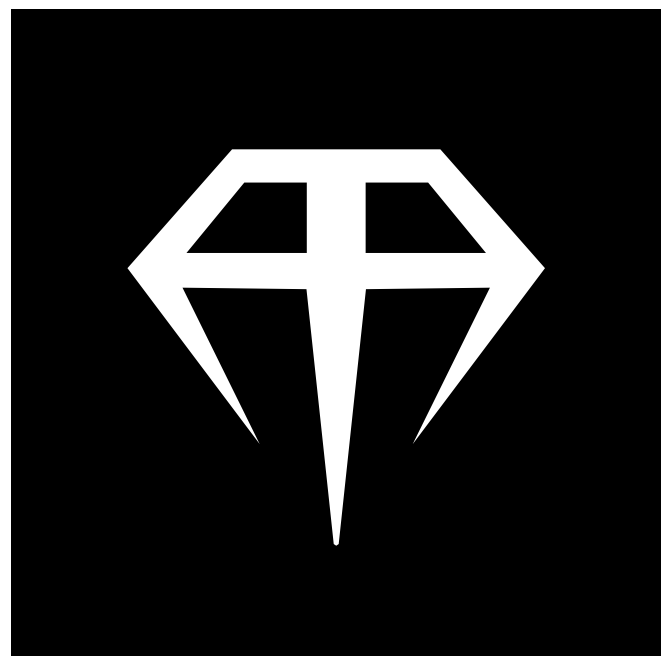

Mancuernas

02

Ingeniería de Precisión

Piezas que fusionan la micro-ingeniería con la alta joyería. Un homenaje al diseño estructural para quienes ven el detalle técnico como una forma de arte.



BREITLING
1884

ESPECIFICACIONES



Acero



OBARRIO

PRECIO



\$120

ESPECIFICACIONES



Oro Rosa / 18 Quilates



OBARRIO

PRECIO



\$3,000



Cartier

ESPECIFICACIONES



Acero



OBARRIO

PRECIO



\$500



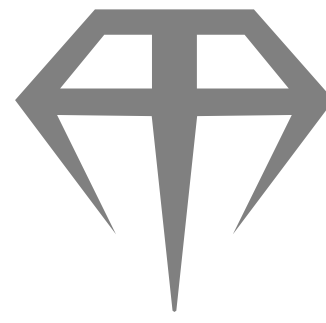

Aquí comienza su próxima gran elección.



Boutique

OBARRIO

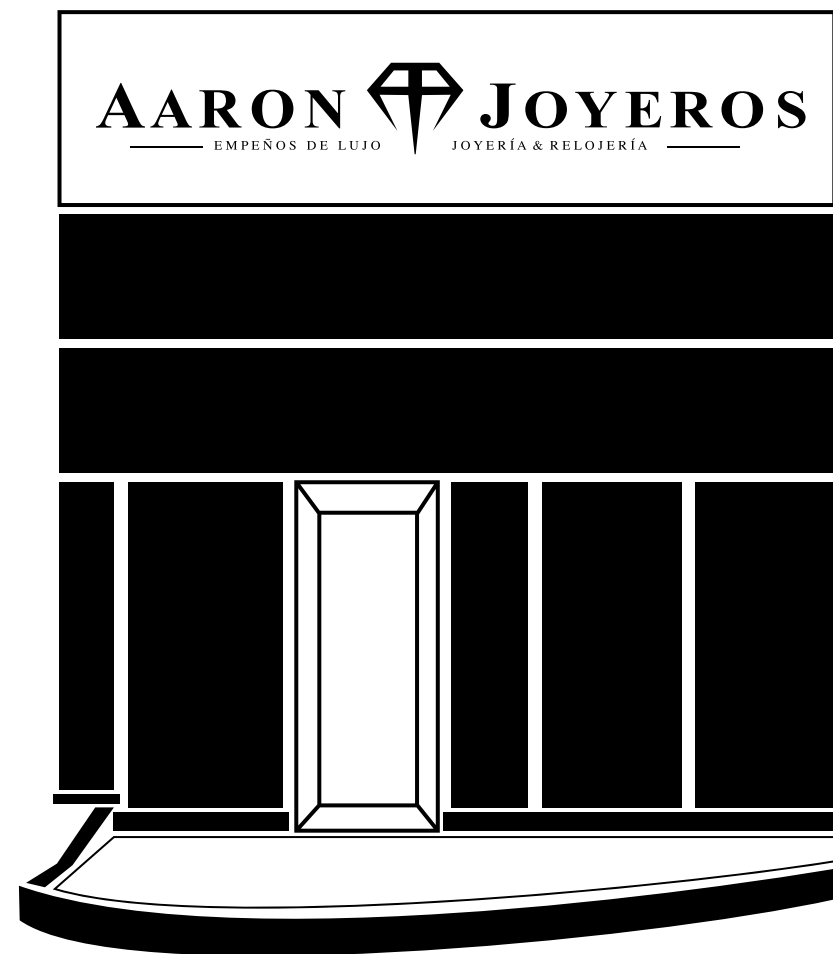

Boutique

COSTA DEL ESTE