



# CATÁLOGO INTERACTIVO

AARON  JOYEROS

# ÍNDICE

Interactivo

## BIENVENIDO A UNA EXPERIENCIA DE LUJO Y PRECISIÓN

Este catálogo interactivo ha sido diseñado para que explores nuestras colecciones de diamantes, bolígrafos y relojes de manera intuitiva y dinámica.



RELOJES

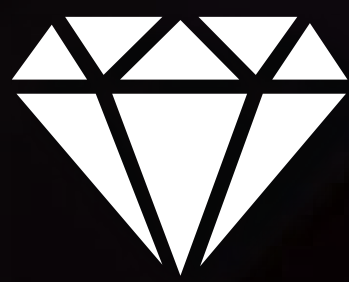

DIAMANTES



BOLÍGRAFOS

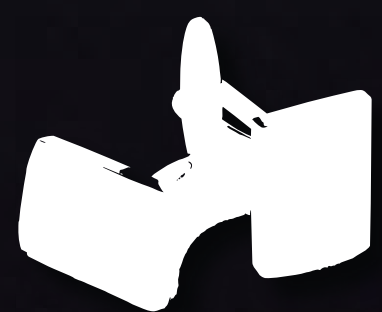

MANCUERNAS

Haz **clic** en cada ícono de categoría para descubrir piezas seleccionadas con los más altos estándares de calidad, autenticidad y distinción. Cada sección te permitirá navegar fácilmente entre detalles, especificaciones y opciones disponibles.



# índice

## CATÁLOGO TOUCH

Toca la marca de tu preferencia para navegar por nuestras exclusivas selecciones

AP  
AUDEMARS PIGUET  
Le maître de l'horlogerie depuis 1875

CHAUMET  
PARIS

GUCCI  

PIAGET

Alain Silberstein®

Chopard  
GENÈVE

  
HAMILTON

RW  
RAYMOND WEIL  
GENÈVE

  
AZIMUT

CONCORD

  
HARRY WINSTON

  
REVUE THOMMEN  
Since 1853

BALL

  
CORUM

 HUBLOT

  
ROGER DUBUIS

  
BAUME & MERCIER  
MAISON D'HORLOGERIE GENEVE 1830

  
DEVON

IWC  
SCHAFFHAUSEN

  
ROLEX

JB  
1735  
BLANCPAIN

DUMOREAU

  
JAEGER-LECOULTRE

  
TAGHeuer  
SWISS AVANT-GARDE SINCE 1860

Bell & Ross

  
EBEL

LONGINES  

TIFFANY & Co.

B  
BOUCHERON  
PARIS

  
EBERHARD & Co

MONT  
BLANC 

  
TISSOT

  
Breguet  
Depuis 1775

  
EDOX

MAURICE  LACROIX  
Manufacture Horlogère Suisse

  
TUDOR

  
BREITLING  
1884

  
FENDI

  
OMEGA

U-BOAT

BVLGARI

  
FREDERIQUE CONSTANT  
GENÈVE

ORIS  
HÖLSTEIN 1904

ULYSSE NARDIN  
SINCE 1846  LE LOCLE - SUISSE

Cartier

GP  
GIRARD-PERREGAUX

PANERAI

  
VACHERON CONSTANTIN  
GENÈVE

CHANEL

GRAHAM  
LONDON

  
CHARRIOL  
GENÈVE

Van Cleef & Arpels

Vintage

AARON  JOYEROS

JOYERIA & RELOJERIA

# CÓMO LLEGAR a nuestras Boutiques?

Haz clic en el ícono o el QR para ir a **Google Maps**.



**Boutique**  
OBARRIO

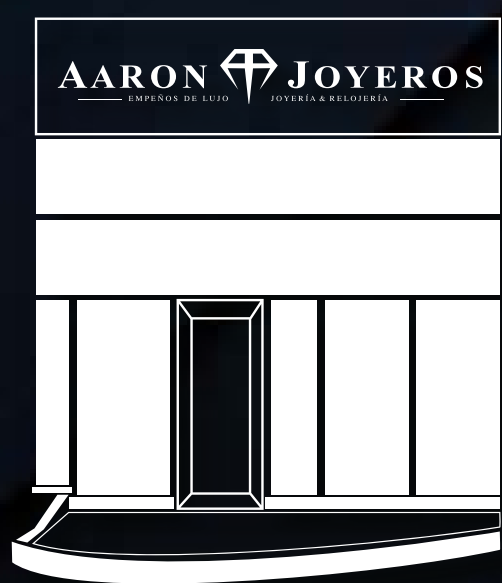

**Boutique**  
COSTA DEL

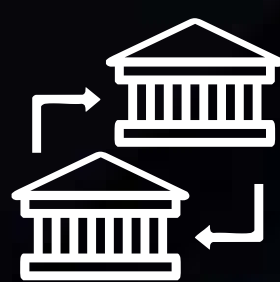

Transferencia  
Bancaria

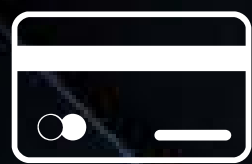

Tarjeta de  
Crédito



Tarjeta  
Clave



Cheques



6225-5554

Whatsapp



aronjoyerospty

Compramos y vendemos relojes y joyería 100% original.  
NO SOMOS DISTRIBUIDOR AUTORIZADO.  
Precios sujetos a cambios.

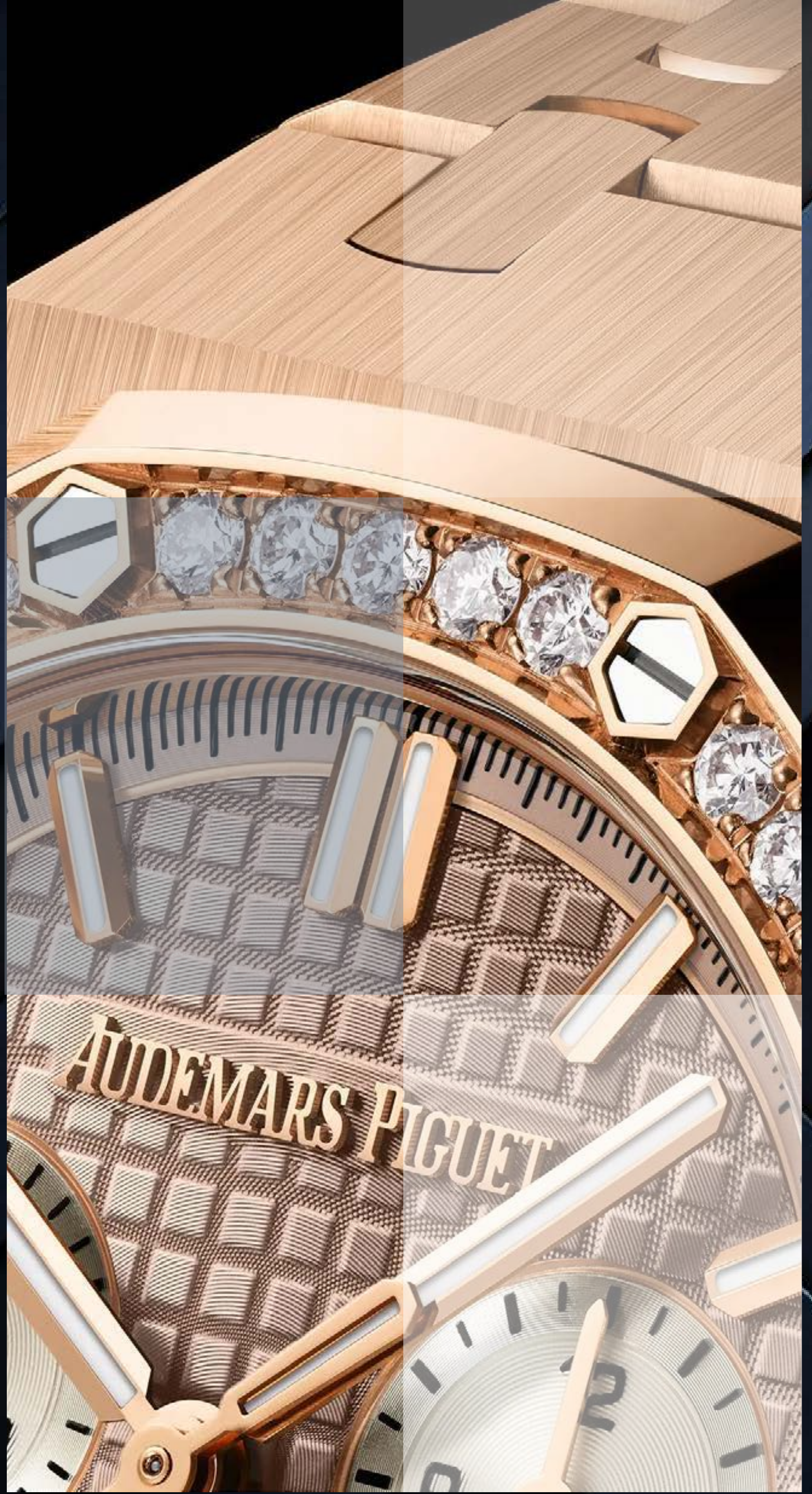

AP  
AUDEMARS PIGUET  
*Le maître de l'horlogerie depuis 1875*

Fundada en 1875 y reconocida por su independencia, innovación técnica y excelencia artesanal. Ha destacado por el desarrollo de complicaciones de alto nivel y por revolucionar el diseño relojero con piezas icónicas como el Royal Oak. Su enfoque combina tradición, ingeniería avanzada y una estética audaz, representando exclusividad y vanguardia en la alta relojería.

**ROYAL OAK**  
**OFFSHORE**



 ACERO

 mm

 AUTOMÁTICO

**PRECIO**  
**\$24,000**



OBARRIO



CAJA



PAPELES

REF. 15703ST.00.A002CA.01

**ROYAL OAK**

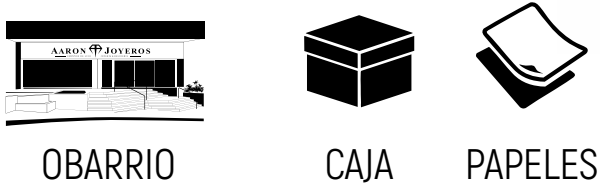

-  ORO ROSA
-  44 mm
-  AUTOMÁTICO

**PRECIO**  
 \$40,000



REF. 26401RO.00.A

**ROYAL OAK**

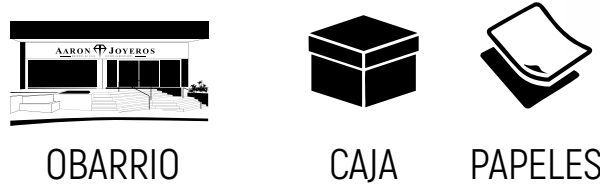

-  ORO ROSA
-  44 mm
-  AUTOMÁTICO

**PRECIO**  
 \$42,000



REF. 26401RO.00.A

**ROYAL OAK VOLCANO**

-  ACERO
-  42 mm
-  AUTOMÁTICO

**PRECIO**  
 \$20,000



REF. 26170ST. 00.D101CR.01

**ROYAL OAK**

-  ORO / DIAMANTES
-  29 X 38 mm
-  QUARTZ

**PRECIO**  
 \$24,000



REF. 6005BA

**VINTAGE**

-  ORO AMARILLO
-  30.5 mm
-  QUARTZ

**PRECIO**  
 \$15,000



REF. AP03022201X

**VINTAGE**

-  ORO AMARILLO
-  32 mm
-  QUARTZ

**PRECIO**  
 \$24,000



REF. VINTAGE



*Alain Silberstein*<sup>®</sup>

Fundada en 1875 y reconocida por su independencia, innovación técnica y excelencia artesanal. Ha destacado por el desarrollo de complicaciones de alto nivel y por revolucionar el diseño relojero con piezas icónicas como el Royal Oak. Su enfoque combina tradición, ingeniería avanzada y una estética audaz, representando exclusividad y vanguardia en la alta relojería.

AARON  JOYEROS

Alain Silberstein®

ÍNDICE



# KRONO BAUHAUS 2

TITANIUM



45 mm



AUTOMÁTICO

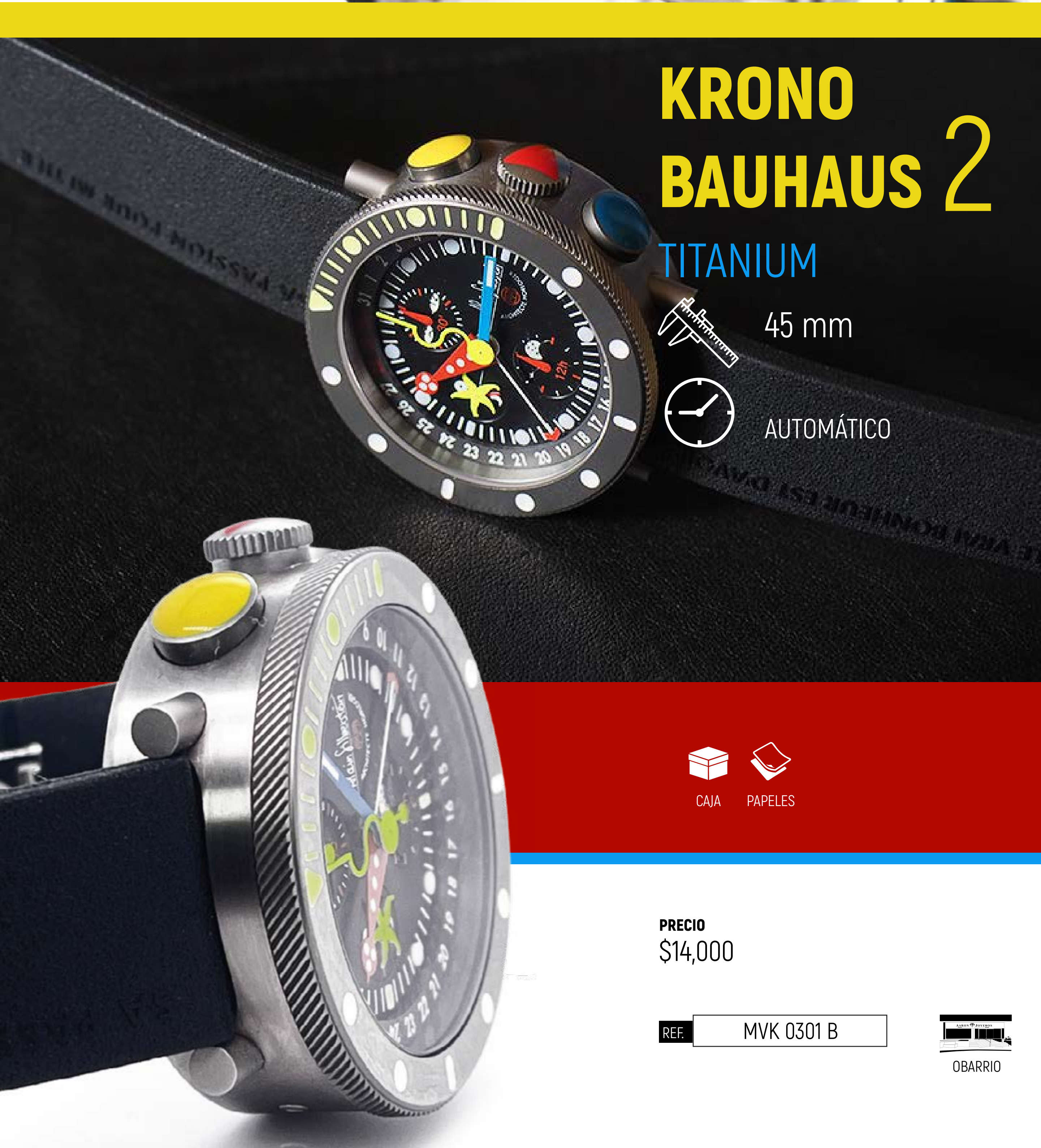

CAJA



PAPELES

PRECIO

\$14,000

REF.

MVK 0301 B



OBARRIO

AARON JOYEROS

JOYERIA & RELOJERIA



  
AZIMUTH

Azimuth es una marca de relojería independiente reconocida por sus diseños futuristas, creatividad mecánica y enfoque poco convencional dentro de la alta relojería contemporánea. Sus relojes destacan por complicaciones originales, indicaciones innovadoras del tiempo y una estética audaz inspirada en la ingeniería, la ciencia ficción y el automovilismo, convirtiéndose en piezas exclusivas para coleccionistas que buscan originalidad y carácter.

AARON  JOYEROS

# GRAN TURISMO

## BLACK PVD



ACERO

50 mm

AUTOMÁTICO

PRECIO  
\$3,000



OBARRIO



AZ.GT.BLKPVD

REF.



# BALL

Ball Watch Company es una marca suiza reconocida por su precisión y resistencia, con raíces en la relojería ferroviaria estadounidense. Sus relojes destacan por su durabilidad y el uso de microtubos de gas que garantizan una excelente visibilidad en la oscuridad.

Ball representa fiabilidad, ingeniería y rendimiento dentro de la relojería técnica.

# BALL

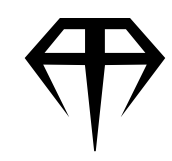

ÍNDICE



## ENGINEER III MARVELIGHT CHRONOMETER

REF. NM9026C-S44C-TQR



ACERO



43 mm



AUTOMÁTICO

PRECIO

\$2,000



OBARRIO



CAJA



PAPELES



AARON  JOYEROS

## CAPELAND CHRONOGRAPH

 ACERO

 43 mm

 AUTOMÁTICO

**PRECIO**  
\$1,500



OBARRIO



CAJA



REF.

CM1030D





**BAUME & MERCIER**  
MAISON D'HORLOGERIE GENEVE 1830

Reconocida por su elegancia equilibrada y su enfoque accesible dentro del lujo, Baume & Mercier se posiciona como una distinguida casa suiza de alta relojería. Sus colecciones, como Classima y Clifton, reflejan un estilo clásico con matices contemporáneos, enfocado en la sobriedad y la precisión.

A lo largo de su trayectoria, la marca ha mantenido un firme compromiso con la calidad y el diseño refinado, creando piezas versátiles para el día a día. Baume & Mercier representa armonía, fiabilidad y elegancia atemporal en la relojería suiza.

AARON  JOYEROS



**BAUME & MERCIER**  
MAISON D'HORLOGERIE GENEVE 1830

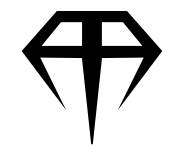

ÍNDICE

# CHRONOGRAPH

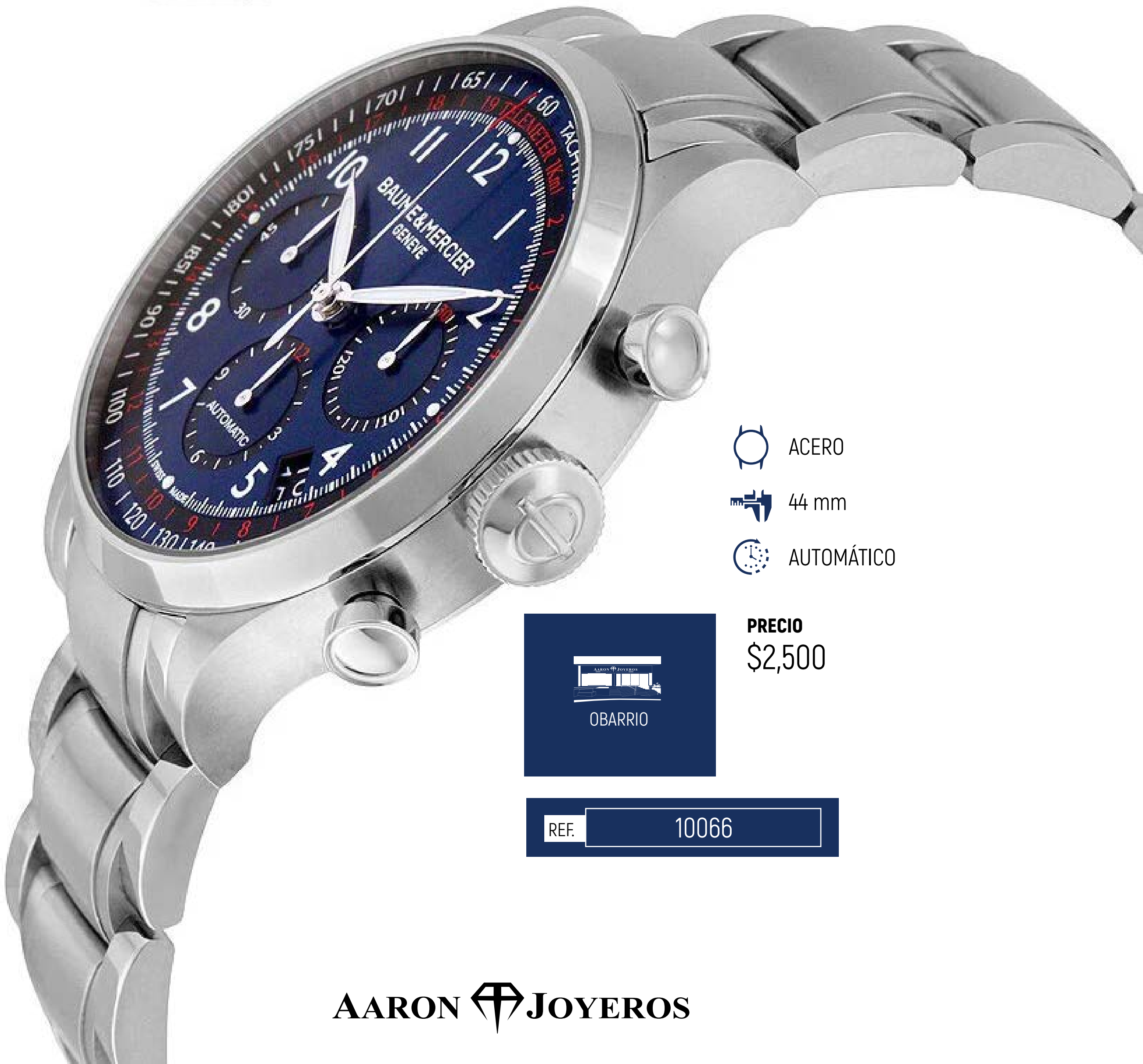

ACERO



44 mm



AUTOMÁTICO





**PRECIO**  
**\$2,500**

REF.

10066

## RIVIERA

-  ACERO
-  43 mm
-  AUTOMÁTICO

**PRECIO**  
\$1,800





OBARRIO



REF. 65541

## RIVIERA

-  ACERO
-  38 mm
-  AUTOMÁTICO

**PRECIO**  
\$1,500



OBARRIO



CAJA





PAPELES



REF. 26310R.00

## RIVIERA

-  ACERO
-  43 mm
-  AUTOMÁTICO

**PRECIO**  
\$1,500



OBARRIO



REF. 65541

## CLASSIMA

-  ORO
-  24 mm
-  QUARTZ

**PRECIO**  
\$1,800



OBARRIO



REF. MV045088

## RECTANGLE MOTHERS OF PEARLS

-  ACERO / ORO
-  22 X 33 mm
-  QUARTZ

**PRECIO**  
\$800



OBARRIO



REF. 8600

## VINTAGE

-  ACERO
-  27 mm
-  QUARTZ

**PRECIO**  
\$1,800



OBARRIO



REF. 65347

## HAMPTON SPIRIT

"DIAL MADRE PERLA"

-  ACERO
-  30 X 31 mm
-  QUARTZ

**PRECIO**  
\$1,000



REF. MOA08450

## TANK

-  ACERO
-  22 x 33 mm
-  QUARTZ

**PRECIO**  
\$2,500



REF. 97256

## HAMPTON CHRONOGRAPH

-  ACERO
-  29 X 44 mm
-  QUARTZ

**PRECIO**  
\$1,000



REF. 65341

## CATWALK



-  ACERO / DIAMANTES
-  21 mm
-  QUARTZ

**PRECIO**  
\$650



REF. MV045219

## HAMPTON



-  ACERO
-  32 mm
-  AUTOMÁTICO

**PRECIO**  
\$950



REF. 65697

## CLIFTON GMT

-  ACERO
-  43 mm
-  AUTOMÁTICO

**PRECIO**  
\$1,500



REF. MOA10112

**HAMPTON**  
CRONÓGRAFO

-  ACERO
-  34 x 29 mm
-  QUARTZ

**PRECIO**  
\$700





OBARRIO

REF. 65341



**HAMPTON**

-  ACERO
-  42 x 39 mm
-  AUTOMÁTICO

**PRECIO**  
\$575





OBARRIO

REF. 65402



**CLASSIMA**  
EXECUTIVE

-  ORO
-  38 mm
-  AUTOMÁTICO

**PRECIO**  
\$7,000



OBARRIO

REF. 65627



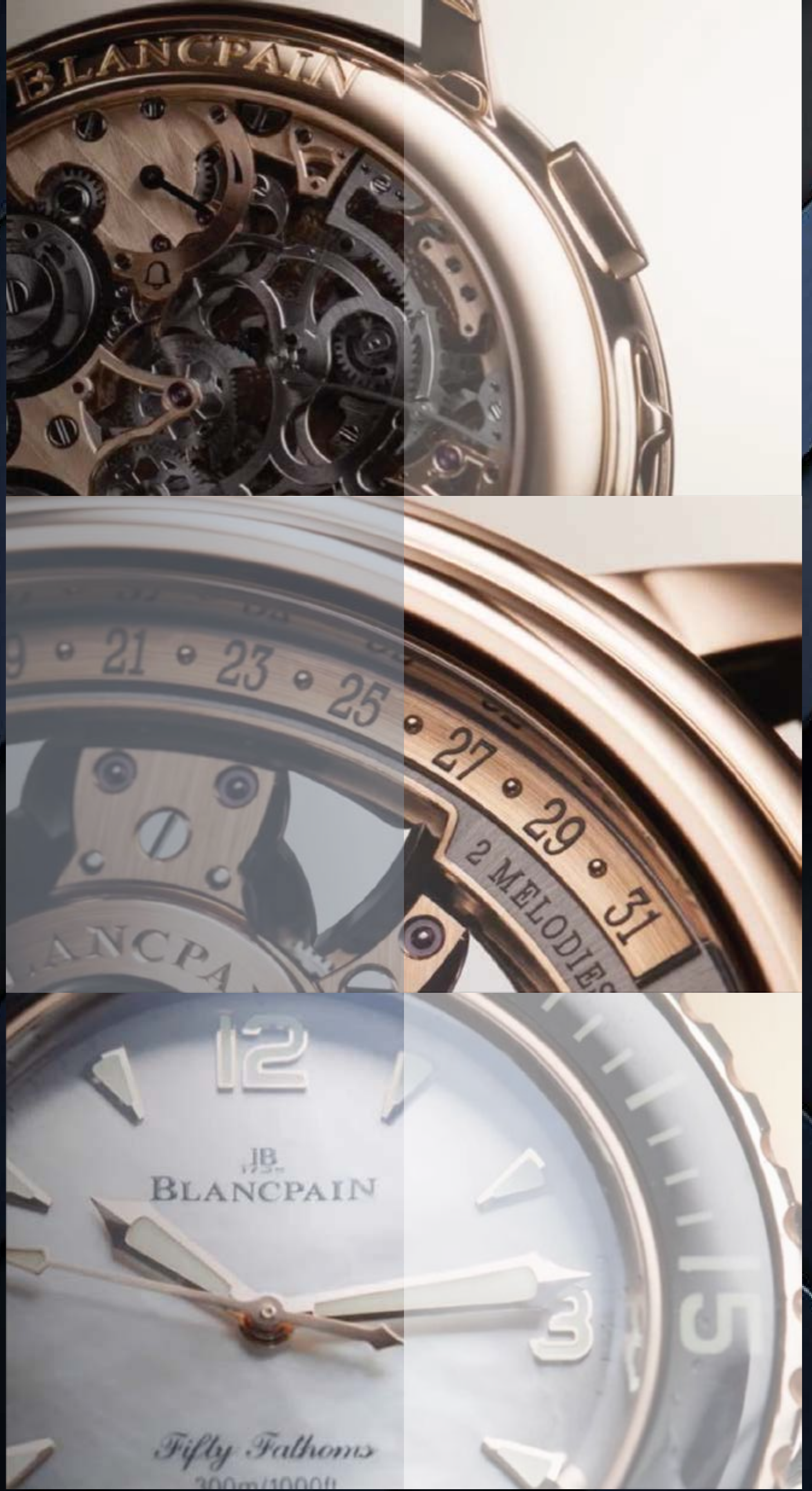



**JB**  
1735  
**BLANCPAIN**  
MANUFACTURE DE HAUTE HORLOGERIE

Blancpain es una de las casas más emblemáticas de la alta relojería, reconocida por su profunda tradición, innovación mecánica y compromiso con la artesanía. Ha destacado por la creación de relojes de gran complejidad y por modelos icónicos como el Fifty Fathoms. Su enfoque une herencia, precisión y elegancia atemporal, representando exclusividad y excelencia relojera.



# VILLERET



-  ORO BLANCO / DIAMANTES
-  40 mm
-  AUTOMÁTICO

**PRECIO**  
\$12,500

REF. 4063-1560-55



**GMT**  
FIFTY FATHOMS

 ACERO

 40.5 mm

 AUTOMÁTICO

**PRECIO**  
\$7,500



OBARRIO



REF. 2250.1130.71





# Bell & Ross

Bell & Ross es una firma reconocida por su diseño inspirado en la aviación y los instrumentos aeronáuticos, combinando funcionalidad, precisión y estética contemporánea. Sus relojes destacan por cajas cuadradas icónicas, legibilidad excepcional y un enfoque técnico que refleja innovación, carácter y espíritu militar moderno.



AARON  JOYEROS

# PHANTOM

ÍNDICE

Bell & Ross



-  ACERO
-  42 mm
-  AUTOMÁTICO

PRECIO  
\$2,400



REF. BR0392-BL-CE



OBARRIO

AARON  JOYEROS



Bell & Ross

# AVIATION



REF. BR01-92-SHE

REF.

-  ACERO
-  46 mm
-  AUTOMÁTICO

PRECIO  
\$3,300



OBARRIO





  
**BOUCHERON**  
PARIS

Boucheron es una histórica casa parisina reconocida por su excelencia en alta joyería y su enfoque artístico en la relojería. Sus creaciones combinan diseño innovador, elegancia y un fuerte carácter estético.

Boucheron representa creatividad, sofisticación y savoir-faire dentro del universo del lujo.

# REFLET DIAMANTE



 ACERO

 18 x 29 mm

 QUARTZ

**PRECIO**  
\$1,200

REF. 20 30 53



OBARRIO



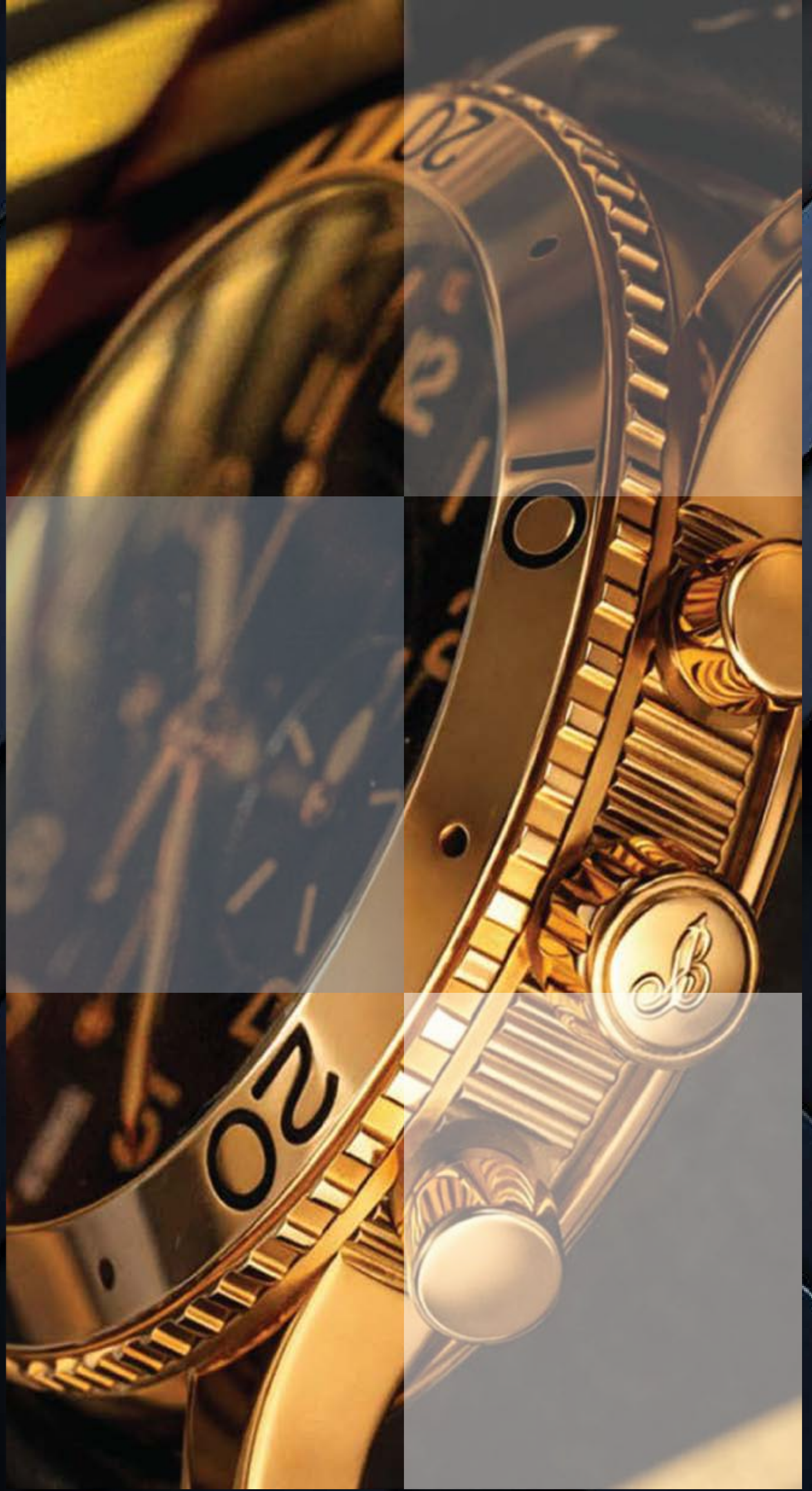

  
*Breguet*  
Depuis 1775

Breguet es una de las casas más influyentes en la historia de la relojería, reconocida por su innovación, elegancia y legado técnico. Sus creaciones se distinguen por detalles clásicos como las agujas Breguet y esferas guilloché, reflejando un estilo refinado y atemporal.

Breguet representa tradición, sofisticación y una profunda contribución al desarrollo de la alta relojería.

AARON  JOYEROS

## AERONAVALE

 ORO ROSA / CUERO

 39 mm

 AUTOMÁTICO

**PRECIO**  
\$18,600



OBARRIO



REF. 3800





  
**BREITLING**  
**1884**

Reconocida casa suiza de alta relojería, destacada por su precisión, innovación y fuerte vínculo con la aviación. Ha sobresalido por el desarrollo de cronógrafos profesionales y modelos icónicos como el Navitimer. Su enfoque combina rendimiento, funcionalidad y diseño robusto, representando espíritu técnico y excelencia en relojería deportiva.

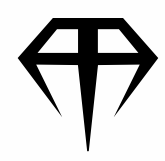

ÍNDICE



**BREITLING**

1884

# NAVITIMER B03

CHRONOGRAPH RATTRAPANTE 45



ACERO

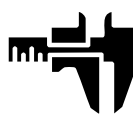

45 mm

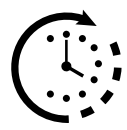

AUTOMÁTICO

**PRECIO**

**\$7,800**



OBARRIO



CAJA



PAPELES

REF.

AB03102A1F1A1



**BREITLING**  
1884

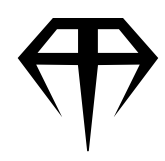

ÍNDICE



# NAVITIMER CHRONOGRAPH



ACERO



45 mm



AUTOMÁTICO

PRECIO

\$7,000



CAJA



PAPELES

REF. AB031021/Q615



REF.

B  
BREITLING  
1884



# CHRONOMAT 44

## RAVEN

-  ACERO
-  44 mm
-  AUTOMÁTICO

PRECIO  
\$4,800



COSTA DEL ESTE

REF. REF. MB0111C2

**AVENGER  
SEAWOLF**



- ACERO
- 45 mm
- AUTOMÁTICO

PRECIO  
\$2,600



OBARRIO

REF. A17330

**STARLINER**

"DIAL AZUL MADRE PERLA"



- ACERO
- 30 mm
- QUARTZ

PRECIO  
\$2,800



OBARRIO

REF. A71340

**NAVITIMER**



- ACERO
- 38 mm
- AUTOMÁTICO

PRECIO  
\$3,200

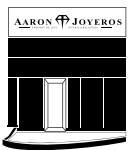

COSTA DEL ESTE

REF. A17325211C1P3

**AVENGER**



- ACERO
- 44 mm
- AUTOMÁTICO

PRECIO  
\$3,500



OBARRIO

REF. A32320

**SUPER AVENGER**



- ACERO
- 45 mm
- AUTOMÁTICO

PRECIO  
\$3,500



OBARRIO

REF. A73321

**SUPER OCEAN**



- ACERO
- 44 mm
- AUTOMÁTICO

PRECIO  
\$4,000



COSTA DEL ESTE

REF. A13341

## CHRONOMANT EVOLUTION

ACERO / ORO

44 mm

AUTOMÁTICO

PRECIO  
\$6,800



OBARRIO



REF. CB0110

## COCKPIT B50 NIGHT MISSION

TITANIO

46 mm

QUARTZ

PRECIO  
\$4,800



OBARRIO



REF. VB501022.BD41

## ENDURANCE PRO

CARBONO

44 mm

QUARTZ

PRECIO  
\$2,600



OBARRIO



CAJA



PAPELES



REF. X82310A51B1S1

## COCKPIT

"NUEVO A ESTRENAR"

ACERO

45 mm

QUARTZ

PRECIO  
\$4,800



OBARRIO



CAJA



PAPELES



REF. VB5010

## CHRONO COCKPIT

ACERO / ORO

39 mm

AUTOMÁTICO

PRECIO  
\$3,000



OBARRIO



REF. B13358

## EXOSPACE

TITANIO

46 mm

QUARTZ

PRECIO  
\$4,500



OBARRIO



REF. VB5510

## CHRONOMAT

- ACERO
- 47 mm
- AUTOMÁTICO

PRECIO  
\$4,200



OBARRIO



REF. AB0412



## AVENGER

- TITANIO
- 44 mm
- AUTOMÁTICO

PRECIO  
\$3,000



OBARRIO



REF. E13360

## SUPER AVENGER

- ACERO
- 48 mm
- AUTOMÁTICO

PRECIO  
\$3,800



OBARRIO



REF. A13370

## COLT GMT

- ACERO
- 40.5 mm
- AUTOMÁTICO

PRECIO  
\$2,200



OBARRIO



REF. A3235011

## GALACTIC 36 SLEEK

- ACERO
- 36 mm
- AUTOMÁTICO

PRECIO  
\$2,300



COSTA DEL ESTE



REF. W74330

**BENTLEY**  
WRISTWATCH

- TITANIO
- 49 mm
- AUTOMÁTICO

PRECIO  
\$6,000



OBARRIO



REF. E273622/BC63

**COLT CHRONOGRAPH**

- ACERO
- 41 mm
- QUARTZ

PRECIO  
\$2,000



OBARRIO



REF. A73380

**LADY J**

- ACERO
- 31 mm
- QUARTZ

PRECIO  
\$2,500



OBARRIO



REF. D52065

**AVENGER**

- ACERO
- 43 mm
- AUTOMÁTICO

PRECIO  
\$3,500



OBARRIO



CAJA



PAPELES



REF. A17318

**AEROSPACE**

- ORO
- 40 mm
- QUARTZ

PRECIO  
\$7,000



OBARRIO



REF. K65062



# BVLGARI

Bvlgari destaca en la alta relojería por su enfoque creativo y su capacidad de reinterpretar el diseño clásico con una estética contemporánea. Reconocida por piezas emblemáticas como el Octo, ha logrado unir ingeniería suiza con una fuerte identidad italiana. Sus creaciones reflejan innovación, carácter arquitectónico y una visión moderna del lujo relojero.

BVLGARI



REF. DGP40C6GLDGMT



DIAGONO

-  ORO ROSA
-  40 mm
-  AUTOMÁTICO



OBARRIO



PRECIO  
\$14,500

GMT

## DIAGONO



REF. 42 SC CH

-  Acero
-  Automático
-  42 mm

PRECIO   
\$7,000





OBARRIO

## DIAGONO GMT

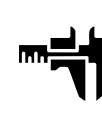

REF. DP42SGMT

-  Acero
-  42 mm
-  Automático

PRECIO   
\$4,500





OBARRIO

## DANIEL ROTH



REF. BRE 56S CHS

-  Acero
-  Automático
-  47 mm

PRECIO   
\$7,000





OBARRIO

## OCTO FINISSIMO

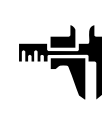

REF. BGO40C

-  Acero
-  Automático
-  40 mm

PRECIO   
\$12,500



OBARRIO



CAJA



PAPELES

## MOP LADY

"MADRE PERLA"



REF. BBL P37 SG

-  Acero/Oro Rosa
-  37 mm
-  Automático

PRECIO   
\$7,000



OBARRIO





PAPELES

## OCTO FINISSIMO



REF. 104190



-  Oro Rosa
-  40 mm
-  Automático

PRECIO   
\$32,600



OBARRIO

## SOTIRIO

-  Oro Rosa
-  42 mm
-  Automático

PRECIO   
\$13,500



REF. 101705

## B.ZERO1



-  Acero
-  35 mm
-  Quartz

PRECIO   
\$1,800



REF. BZ35BHDSGL/2

## DANIEL ROTH

-  Acero
-  28.6 mm
-  Automático

PRECIO   
\$900



REF. BRE 56S CHS

## RETTANGOLO



-  Acero
-  38.4 mm
-  Quartz

PRECIO   
\$1,800



REF. RT39S

## DIAGONO



-  ACERO
-  AUTOMÁTICO
-  40 MM

PRECIO   
\$2,500



REF. DG 40 SV

## DIAGONO



-  ACERO
-  38 MM
-  Automático

PRECIO   
\$3,500



REF. BB 38 SS CH

## DIAGONO GMT

-  Oro Rosa
-  40 mm
-  Automático

PRECIO   
\$14,500





OBARRIO



REF. DGP40C6GLDGMT

## ASSIOMA

-  Acero
-  48 mm
-  Automático

PRECIO   
\$4,000



OBARRIO



REF. AA 48 S.CH

## BVLGARI LADY

-  Acero/Diamante
-  33 mm
-  Automático

PRECIO   
\$3,500



OBARRIO



CAJA



REF. BBL 33WSLC4

## BVLGARI

-  Acero
-  23 mm
-  Quartz

PRECIO   
\$1,000



OBARRIO





PAPELECAJA



REF. BB23SS

## RETTANGOLO

-  Oro Amarillo
-  25 X 45 mm
-  Automático

PRECIO   
\$7,850





OBARRIO



REF. RT 45 G

## DIAGONO

-  Titanio
-  38 mm
-  Automático

PRECIO   
\$2,500



OBARRIO



REF. TI 38 R



# Cartier

Prestigiosa maison de lujo reconocida por su herencia histórica, excelencia artesanal y enfoque artístico en la alta relojería.

A lo largo de su trayectoria, Cartier ha sabido fusionar innovación técnica con una profunda sensibilidad estética, dando vida a piezas que trascienden el tiempo. Hoy, la marca representa elegancia, sofisticación y un legado de creatividad que continúa influyendo en la relojería contemporánea.

AARON  JOYEROS

# Cartier

## PANTHERE VENDOME

"18K"

 Oro Amarillo

 22 mm

 Quartz

PRECIO 

\$9,650



COSTA DEL ESTE

AARON  JOYEROS

PANTHERE	SANTOS	TANK	ROADSTER	BALLON BLEU	PASHA
RONDE	CLÉ	CALIBRE			

## PANTHERE COUGAR

 Oro Amarillo

 33 mm

 Quartz

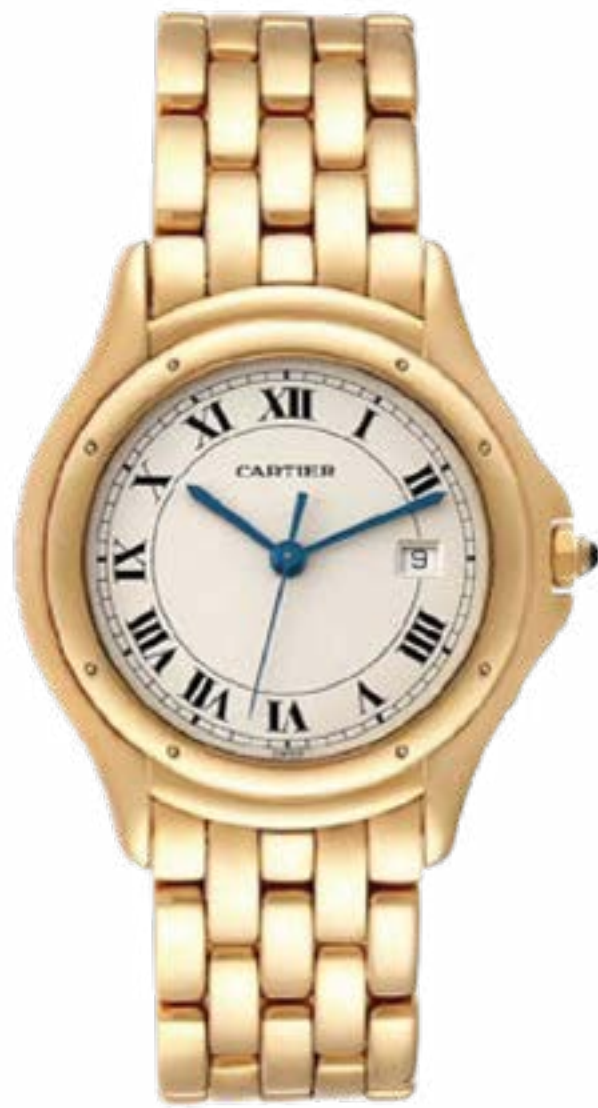

**PRECIO**  
\$18,650



OBARRIO

REF. 887904



# Cartier



Oro



39.8 mm



Automático

PRECIO



\$35,000



OBARRIO



CAJA

AARON  JOYEROS

PANTHERE	SANTOS	TANK	ROADSTER	BALLON BLEU	PASHA
RONDE	CLÉ	CALIBRE			

## SANTOS GALBBÉ



-  Acero
-  29 mm
-  Quartz

PRECIO   
\$5,500



REF. 1564

## SANTOS XL

-  Acero
-  39.8 mm
-  Automático



PRECIO   
\$6,500



REF. 4072



## SANTOS RONDÉ

-  Acero / Oro
-  33 mm
-  Automático

PRECIO   
\$5,000



REF. 1910

## SANTOS GALBBÉ

-  Acero
-  29 mm
-  Quartz



PRECIO   
\$5,200



REF. 1564



## SANTOS GALBBÉ

-  Acero / Oro
-  29 mm
-  Automático



PRECIO   
\$6,000



REF. 1172961

PANTHERE	SANTOS	TANK	ROADSTER	BALLON BLEU	PASHA
RONDE	CLÉ	CALIBRE			

## TANK SOLO XL



-  Acero
-  31 mm
-  Automático

PRECIO   
\$4,500



REF. 3800

## TANK ANGLAISE



-  Oro Rosa
-  47 X 35.2 mm
-  Automático

PRECIO   
\$35,520



REF. W531002

## TANK AMERICANO



-  Oro Blanco
-  41 mm
-  Automático

PRECIO   
\$15,000



REF. 1726

## TANK



-  Oro Amarillo
-  28 X 36 mm
-  Automático

PRECIO   
\$6,650



REF. 1830

## TANK

-  Acero / Oro
-  25 mm
-  Automático

PRECIO   
\$5,500



REF. 2619

PANTHERE	SANTOS	TANK	ROADSTER	BALLON BLEU	PASHA
RONDE	CLÉ	CALIBRE			

## ROADSTER

-  Oro 18 K
-  38 x 43 mm
-  Automático

PRECIO   
\$20,650





OBARRIO



REF. 2619

## ROADSTER

"18 QUILATES"

-  Oro Amarillo
-  47.6 x 42.8 mm
-  Automático

PRECIO   
\$20,850





OBARRIO



REF. 2619

## ROADSTER

"18 QUILATES"

-  Oro Amarillo
-  44 x 37 mm
-  Automático

PRECIO   
\$14,500





OBARRIO



REF. 2524

## ROADSTER TORTUE PERPETUAL

-  Oro Rosa
-  42.5 34 mm
-  Automático

PRECIO   
\$30,000





OBARRIO



REF. 2666

## ROADSTER

-  Oro Amarillo
-  47.6 mm
-  Automático

PRECIO   
\$38,000



OBARRIO



REF. 2619

Cartier



Acero



44 mm



Automático

PRECIO



\$6,500



OBARRIO

3109



REF

BALFOUR

AARON  JOYEROS

PANTHERE	SANTOS	TANK	ROADSTER	BALLON BLEU	PASHA
RONDE	CLÉ	CALIBRE			

## BALLON BLEU

-  Oro Blanco
-  36 mm
-  Automático



PRECIO   
\$9,000

-  OBARRIO
-  CAJA



REF. 3004

## BALLON BLEU

-  Acero
-  42 mm
-  Automático



PRECIO   
\$5,000

-  OBARRIO



REF. 3765

## BALLON BLEU

-  Oro Rosa
-  42 mm
-  Automático



PRECIO   
\$13,800

-  OBARRIO



REF. 2999

## BALLON BLEU

-  Oro Rosa
-  44 mm
-  Automático

PRECIO   
\$14,500



-  OBARRIO



REF. 3107

## BALLON BLEU

"BISEL AFTERMARKET"

-  Acero
-  40 mm
-  Automático

PRECIO   
\$6,800

-  OBARRIO



REF. 3001

## BALLON BLEU

-  Acero / Oro Rosa
-  42 mm
-  Automático

PRECIO   
\$9,000



-  OBARRIO
-  CAJA
-  PAPELES



REF. 3765

PANTHERE	SANTOS	TANK	ROADSTER	BALLON BLEU	PASHA
RONDE	CLÉ	CALIBRE			

## BALLON BLEU

-  ACERO
-  42 mm
-  AUTOMÁTICO

PRECIO  
\$5,500





OBARRIO



REF. WSBB0049

## BALLON BLEU

-  ACERO
-  40 mm
-  AUTOMÁTICO

PRECIO  
\$6,300



OBARRIO



CAJA



PAPELES



REF. WSBB0061



# Cartier

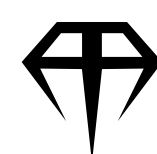

ÍNDICE

PANTHERE	SANTOS	TANK	ROADSTER	BALLON BLEU	PASHA
RONDE	CLÉ	CALIBRE			



# PASHA

 ACERO

 38 mm

 AUTOMÁTICO

PRECIO   
\$4,500

  
OBARRIO





AARON  JOYEROS

PANTHERE	SANTOS	TANK	ROADSTER	BALLON BLEU	PASHA
RONDE	CLÉ	CALIBRE			

## PASHA



-  Oro Blanco
-  32 mm
-  Automático

PRECIO   
\$8,500





OBARRIO

REF. 2528

## PASHA



-  Oro
-  42 mm
-  Automático

PRECIO   
\$30,850



OBARRIO

REF. 2726

## PASHA



-  Oro
-  38 mm
-  Quartz

PRECIO   
\$10,500



COSTA DEL ESTE

REF. 1987

## PASHA



-  Acero
-  33 mm
-  Quartz

PRECIO   
\$3,200





OBARRIO

REF. W3140001



PANTHERE	SANTOS	TANK	ROADSTER	BALLON BLEU	PASHA
RONDE	CLÉ	CALIBRE			

## RONDE SOLO XL

-  Acero
-  42 mm
-  Automático

PRECIO   
\$3,500



CDE



REF. 3802



PANTHERE	SANTOS	TANK	ROADSTER	BALLON BLEU	PASHA
RONDE	CLÉ	CALIBRE			

## CLÉ



REF. 3850

- Acero
- 40 mm
- Automático

PRECIO

\$4,200



OBARRIO

## CLÉ



REF. 3847

- Oro Rosa
- 40 mm
- Automático

PRECIO

\$25,000



OBARRIO



PANTHERE	SANTOS	TANK	ROADSTER	BALLON BLEU	PASHA
RONDE	CLÉ	CALIBRE			

## CALIBRE

- Acero / Oro Rosa
- 42 mm
- Automático

PRECIO \$  
\$6,200



REF. 3389



OBARRIO

## CALIBRE

- Acero / Oro Rosa
- 42 mm
- Automático

PRECIO \$  
\$7,000



REF. 3389



OBARRIO

## CALIBRE

- Oro Rosa
- 42 mm
- Automático

PRECIO \$  
\$37,000



REF. 3300



OBARRIO

## CALIBRE

- Acero / Oro Rosa
- 42 mm
- Automático

PRECIO \$  
\$9,800



REF. W7100042



OBARRIO

## CALIBRE

- Acero / Oro
- 42 mm
- Automático

PRECIO \$  
\$6,000



REF. W2CA0004



OBARRIO



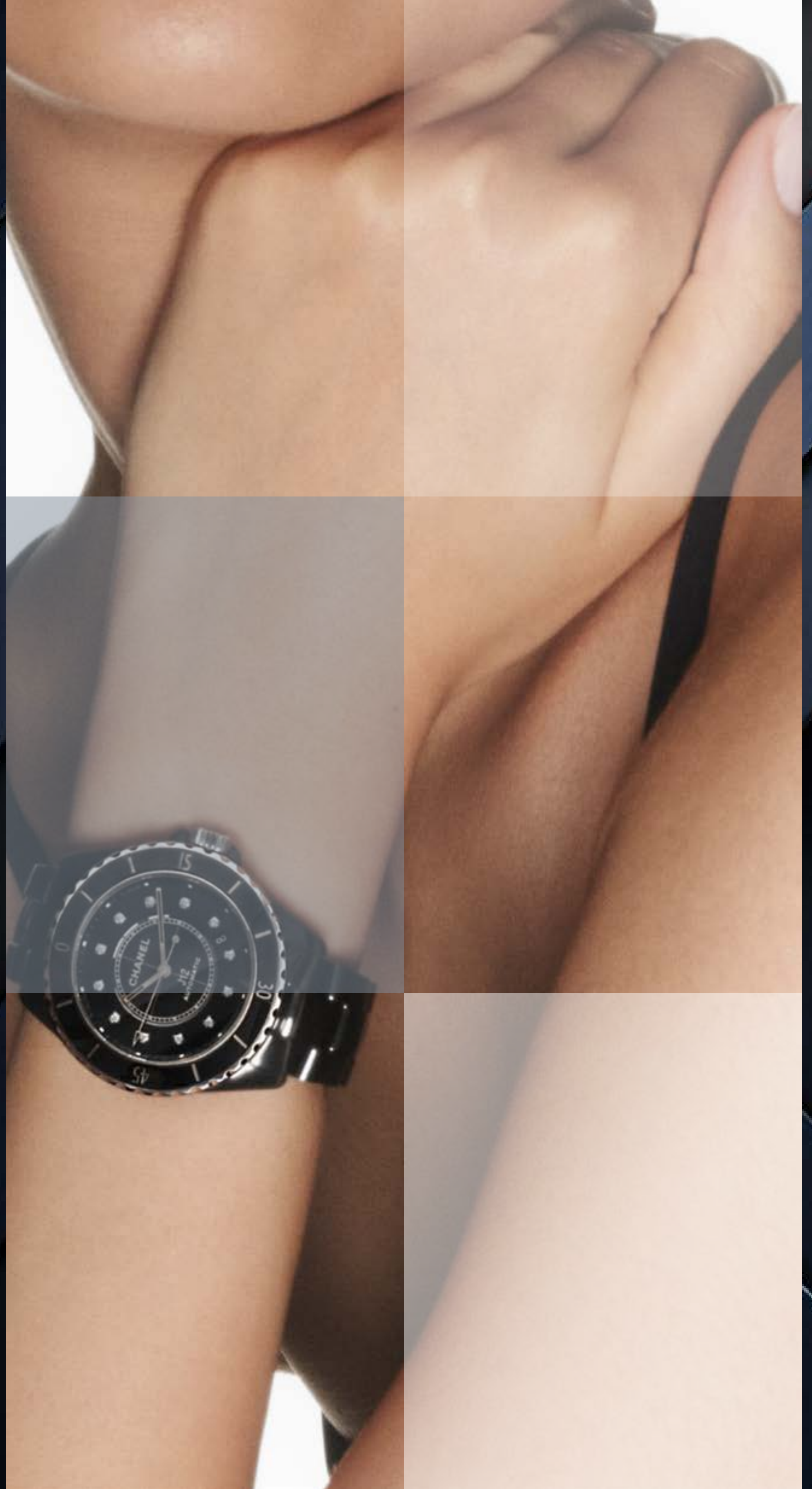

CAJA



# CHANEL

Chanel ha consolidado su presencia en la alta relojería mediante una propuesta que combina diseño vanguardista y precisión suiza. Sus colecciones, como J12 y Première, reflejan una estética distintiva que une elegancia contemporánea y carácter innovado. A lo largo de su evolución, la marca ha redefinido los códigos del reloj femenino y unisex, integrando materiales y formas poco convencionales. Chanel representa estilo, modernidad y una visión creativa única dentro del universo relojero.

## J1

-  Cerámica
-  41 mm
-  Automático

PRECIO   
\$2,750



OBARRIO





PAPELES



REF. H2934

## J12

-  Cerámica
-  39 mm
-  Automático

PRECIO   
\$2,750





OBARRIO



REF. H2934

## J12 NOIRE

-  Cerámica
-  38 mm
-  Automático

PRECIO   
\$2,600



OBARRIO



REF. H5702





# CHAUMET

PARIS

Chaumet ha desarrollado una propuesta relojera que combina elegancia, refinamiento y savoir-faire parisino. Sus creaciones destacan por su diseño delicado y su atención al detalle, integrando la relojería con el arte joyero. A lo largo de su trayectoria, la marca ha sabido expresar sofisticación a través de piezas que priorizan la estética sin perder precisión. Chaumet representa distinción, feminidad y tradición dentro del universo de la alta relojería.

## KHESIS

 Acero/Nácar/Diamantes

 21 mm

 Quartz

PRECIO 

\$2,000





OBARRIO



REF. 40 38 44

## KHESIS

 Acero/Diamantes

 17.5 x 28 mm

 Quartz

PRECIO 

\$1,800



OBARRIO



REF. 1.2330\_PK

## CLASS ONE CHRONO

 Acero

 40 mm

 Quartz

PRECIO 

\$1,800





OBARRIO



REF. 625B

## STYLE

 Acero/Diamantes

 19 x 23 mm

 Quartz

PRECIO 

\$500



OBARRIO



REF. 35 34 13

## MONTRE CHAUMET CHRONOGRAPHE

 Acero

 40 mm

 Automático

PRECIO 

\$3,600



OBARRIO



REF. 0000



# Chopard

## GENÈVE

Chopard es una reconocida casa suiza que combina alta relojería y joyería con un enfoque en la elegancia, la innovación y la artesanía. Sus creaciones destacan por la atención al detalle y el uso de materiales de alta calidad.

A lo largo de su trayectoria, la marca ha desarrollado colecciones icónicas que equilibran técnica y estética, consolidando su presencia en el mundo del lujo. Chopard representa refinamiento, creatividad y excelencia dentro del universo relojero.

# Chopard

GENÈVE



Oro



44 mm



Automático

PRECIO



\$19,000

REF. 61276-5001



OBARRIO

## MILLE MIGLIA



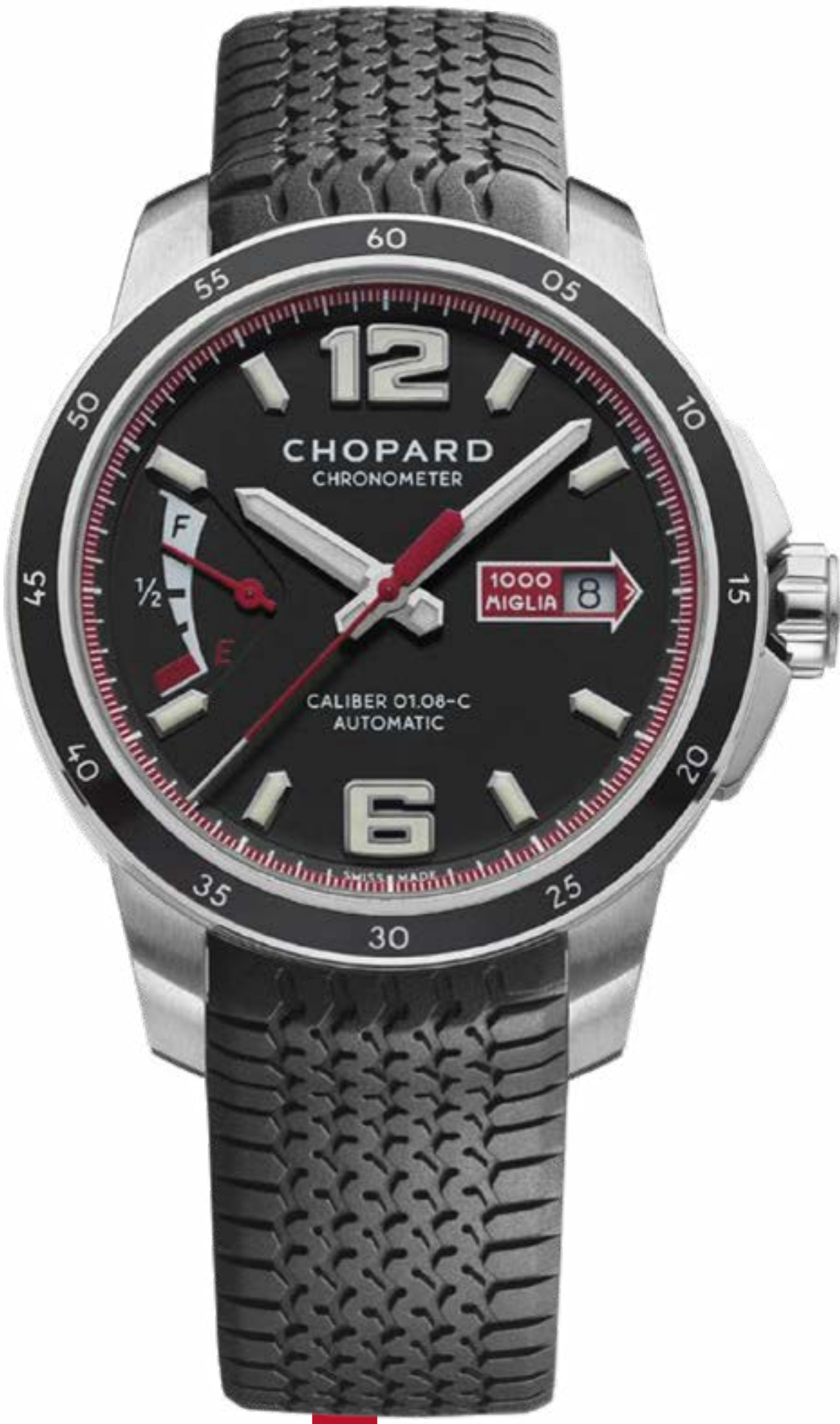

*Chopard*  
GENÈVE

# MILLE MIGLIA GTS





CAJAOBARRIO



PAPELES



## POWER CONTROL

-  ACERO
-  43 mm
-  AUTOMÁTICO

PRECIO   
\$4,800

REF.



*Chopard*  
GENÈVE

## HAPPY DIAMOND

ORO/DIAMANTES

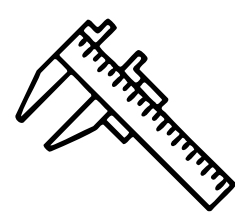

25 mm

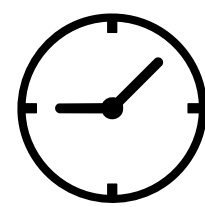

QUARTZ

PRECIO 

\$4,800

REF.

20/5605



OBARRIO



CAJA

**GRAN TURISMO**  
XL

- Acero
- 44 mm
- Automático

PRECIO   
\$4,500



CDE



REF. 8997

**SUPERFAST**

- Acero
- 44 mm
- Automático

PRECIO   
\$5,500



OBARRIO



REF. 8542

**GRAN TURISMO**  
XL

- Acero
- 44 mm
- Automático

PRECIO   
\$3,500



OBARRIO



REF. 8997

**GRAND PRIX  
DE MÓNACO**

- Acero
- 42.5 mm
- Automático

PRECIO   
\$3,800



CDE



REF. 168992-3031

**MIGLIA  
CHRONOGRAPH**

- Oro
- 39 mm
- Automático

PRECIO   
\$16,100



OBARRIO



CAJA



PAPELES



REF. 1274

**HAPPY BEACH**

- Oro Rosa
- 42 mm
- Quartz

PRECIO   
16,000



OBARRIO



REF. 283581-5011

**IMPERIALE**  
CHRONO

- Acero
- Automático
- 38 mm

PRECIO   
\$2,500



OBARRIO CAJA



REF. 8219

**MILLE**  
MIGLIA

- Acero
- Automático
- 38 mm

PRECIO   
\$5,000



OBARRIO CAJA



REF. 8588

**IMPERIALE**  
CHRONO

- Acero
- 37 mm
- Automático

PRECIO   
\$3,000



OBARRIO



REF. 8219

**IMPERIALE**  
CHRONO

- Acero
- 40 mm
- Automático

PRECIO   
\$5,500



OBARRIO CAJA



REF. 8549

**HAPPY SPORT**

- Acero
- 38 mm
- Quartz

PRECIO   
\$4,800



OBARRIO



REF. 8347

**CHOPARD**  
CHOPARD LUNA D'ORO

- Oro Amarillo
- 34 mm
- Quartz

PRECIO   
\$3,875



OBARRIO



REF. 1086

### HAPPY SPORT

- Acero / Oro Rosa
- 36 mm
- Quartz

PRECIO   
\$7,000



OBARRIO



REF. 8475

### HAPPY SPORT

- Acero
- 36 mm
- Quartz

PRECIO   
\$4,500



OBARRIO



CAJA



PAPELES



REF. 8475

### HAPPY SPORT

- Acero
- 42 mm
- Quartz

PRECIO   
\$4,000



OBARRIO



REF. 288525-3002

### HAPPY BEACH DIAMOND BLUE

- Acero
- 38 mm
- Quartz

PRECIO   
\$3,200



OBARRIO



REF. 8542

### HAPPY SPORT

- Acero
- 38 mm
- Quartz

PRECIO   
\$2,000



OBARRIO



REF. 8347

### HAPPY SPORT

- Acero
- 42 mm
- Quartz

PRECIO   
\$4,500



OBARRIO





REF. 288499-3008

**GRAN TURISMO XL**

- Acero
- 44 mm
- Automático

PRECIO   
\$3,500

-  OBARRIO
-  CAJA
-  PAPELES



REF. 8997

**MILLE MIGLIA ALFA ROMEO**

"EDICIÓN LIMITADA"

- Acero
- 42 mm
- Automático

PRECIO   
\$2,400

-  OBARRIO



REF. 8954

**MILLE MIGLIA GRAN TURISMO**

- Acero
- 44 mm
- Automático

PRECIO   
\$3,800

-  OBARRIO



REF. 168997

**MILLE MIGLIA GRAN TURISMO**

- Oro Rosa
- 45 mm
- Automático

PRECIO   
\$22,050

-  OBARRIO
-  CAJA
-  PAPELES



REF. 161264

**MIGLIA**

- Acero
- 40 mm
- Automático

PRECIO   
\$2,600

-  OBARRIO





REF. 8955

**MILLE MIGLIA RACE EDITION**

- ACERO
- 44 mm
- AUTOMÁTICO

PRECIO  
\$5,500

-  OBARRIO
-  CAJA
-  PAPELES



REF. 168571-3004



# CONCORD

Concord es una casa relojera suiza reconocida por su enfoque en la innovación y el diseño contemporáneo dentro del segmento de lujo. Sus creaciones se distinguen por líneas modernas y una marcada identidad estética.

A lo largo de su historia, la marca ha explorado conceptos audaces que rompen con lo tradicional. Concord representa modernidad y evolución en el diseño relojero.



# CONCORD

## CONCORD MARINER

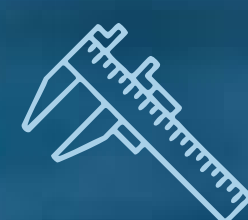

38 mm



AUTOMÁTICO

ACERO  
PRECIO:

PRECIO 

\$950



OBARRIO

REF.

14H71891



# CORUM



Concord es una casa relojera suiza reconocida por su enfoque en la innovación y el diseño contemporáneo dentro del segmento de lujo. Sus creaciones se distinguen por líneas modernas y una marcada identidad estética.

A lo largo de su historia, la marca ha explorado conceptos audaces que rompen con lo tradicional. Concord representa modernidad y evolución en el diseño relojero.

AARON  JOYEROS

### ADMIRAL'S CUP



-  Oro Rosa
-  44 mm
-  Automático

**PRECIO**   
\$12,000





CDE

REF. 753 812

### VINTAGE



-  Oro / Cuero
-  24 mm
-  Quartz

**PRECIO**   
\$4,000



OBARRIO





PAPELES

REF. 0000

### ADMIRAL'S CUP

"BISEL/CORONA ORO ROSA"



-  Acero / Oro
-  48 mm
-  Automático

**PRECIO**   
\$5,500





OBARRIO

REF. A690/04312

### ADMIRAL'S CUP



-  Oro Rosa
-  Automático
-  48 mm

**PRECIO**   
\$12,000



OBARRIO





CAJA

REF. 277.931.91/0371 AG32

### ADMIRAL'S CUP



-  Acero
-  41 mm
-  Automático

**PRECIO**   
\$2,500



OBARRIO

REF. 82.833.20



DEVON

Devon ha fusionado ingeniería de alto nivel con una estética disruptiva. Devon representa vanguardia, innovación y una visión tecnológica del tiempo. Es una innovadora firma estadounidense que ha redefinido la relojería mediante el uso de tecnología avanzada y diseño futurista. Sus relojes destacan por sistemas de correas motorizadas y mecanismos electrónicos únicos, alejándose de la relojería tradicional.

AARON  JOYEROS

# TREAD 2 REDRUM

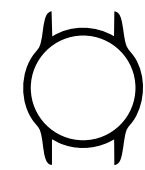

Acero



44.2 x 41.7 mm

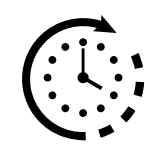

Quartz

PRECIO 

\$6,000



OBARRIO



CAJA

REF.

M0064



# DUMOREAU

Devon ha fusionado ingeniería de alto nivel con una estética disruptiva. Devon representa vanguardia, innovación y una visión tecnológica del tiempo. Es una innovadora firma estadounidense que ha redefinido la relojería mediante el uso de tecnología avanzada y diseño futurista. Sus relojes destacan por sistemas de correas motorizadas y mecanismos electrónicos únicos, alejándose de la relojería tradicional.

# DUMOREAU



 Acero

 38.6 mm

 Automático

PRECIO 

\$700



OBARRIO

REF. DM-01



⌘  
EBEL

La casa Ebel se ha caracterizado por crear piezas que priorizan el detalle y la comodidad en la muñeca. Ebel representa sofisticación discreta y tradición dentro de la relojería suiza. Conocida por su estilo elegante y equilibrado, donde el diseño y la precisión se combinan de forma armoniosa. Sus relojes destacan por líneas refinadas y una estética atemporal que ha definido su identidad a lo largo de los años.

AARON  JOYEROS

# SPORT WAVE



ACERO

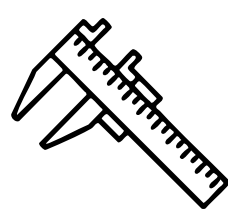

28 mm

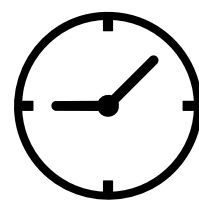

QUARTZ

PRECIO   
\$750

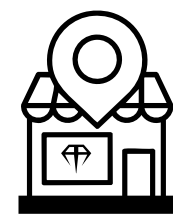

OBARRIO



CAJA

REF.

E9955K41

## SPORT WAVE

- Acero
- 36 mm
- Quartz

PRECIO   
\$900



OBARRIO



REF. E9087622

## CLASSIC WAVE

- Oro Amarillo
- 23 mm
- Quartz

PRECIO   
\$13,300



CDE



REF. 888901

## DRESSWAVE

- Acero y Oro
- 24 mm
- Quartz

PRECIO   
\$700



OBARRIO



REF. E6157912

## SPORT WAVE

- Acero
- 26 mm
- Quartz

PRECIO   
\$1,200



OBARRIO



REF. 12607794

## DRESS WAVE

- Acero
- 35 mm
- Quartz

PRECIO   
\$750



OBARRIO



PAPELES



REF. 98501259

## SPORT WAVE CLASSIC

- Acero / Oro Ama
- 27 mm
- Quartz

PRECIO   
\$800



OBARRIO



REF. E 6187631

## SPORT WAVE

-  Acero
-  36 mm
-  Quartz

PRECIO   
\$900



OBARRIO



REF. E6187631

## EBEL

-  Acero / Oro
-  34 mm
-  Quartz

PRECIO   
\$1,500



OBARRIO



REF. W522084

## LADY SPORT

-  Acero / Oro
-  27 mm
-  Quartz

PRECIO   
\$900



OBARRIO





CAJA



REF. EBL-010

## LADY

-  Acero / Oro
-  23 mm
-  Automático

PRECIO   
\$1,300



OBARRIO



REF. 1057902

## SPORTWAVE

-  Acero
-  36 mm
-  Quartz

PRECIO   
\$400



OBARRIO



REF. E6120531

## E-TYPE

-  Acero
-  36 mm
-  Quartz

PRECIO   
\$1,000



OBARRIO



REF. E9187C41



  
**EBERHARD & Co**

Eberhard & Co. es una prestigiosa casa relojera suiza fundada en 1887, reconocida por su tradición en relojes deportivos y cronógrafos de alta precisión.

La marca se ha distinguido por combinar elegancia clásica, innovación mecánica y una fuerte identidad técnica. Sus colecciones destacan por diseños refinados, movimientos de calidad y una atención minuciosa a los detalles.

**AARON  JOYEROS**

## 8 DÍAS



REF. 20017

-  Oro
-  39 mm
-  Cuerda Manual

PRECIO   
\$7,000



OBARRIO



CAJA





  
**EDOX**

Reconocida por su enfoque en la precisión y la resistencia, especialmente en relojes deportivos y de buceo. Sus creaciones combinan ingeniería robusta con un diseño funcional, orientado al rendimiento en condiciones exigentes.

A lo largo de su trayectoria, la marca ha desarrollado modelos fiables y técnicos, consolidando su reputación en la relojería deportiva. Edox representa durabilidad, exactitud y espíritu aventurero.

**AARON  JOYEROS**

## EDOX

 Acero

 46 mm

 Quartz

PRECIO 

\$900



OBARRIO



CAJA



REF. 10021 3 NIN



**F**  
**FENDI**

Fendi combina la elegancia italiana con la precisión suiza, creando relojes que destacan por su diseño sofisticado y moderno. Sus piezas priorizan la estética, los detalles de moda y materiales de alta calidad, posicionándose como accesorios de lujo más que relojes técnicos.

AARON  JOYEROS

## RUN AWAY

-  Acero
-  36 mm
-  Quartz

PRECIO 

\$500



OBARRIO



REF. FOW807A5UGF0QA1

## RUN AWAY

-  Acero
-  36 mm
-  Quartz

PRECIO 

\$340



OBARRIO



REF. F136031573T01



## GP GIRARD-PERREGAUX

Girard-Perregaux es una de las manufacturas relojeras suizas más antiguas, con orígenes que se remontan a 1791. Reconocida por producir sus propios movimientos y por su enfoque en la Alta Relojería, la marca combina innovación técnica, diseño refinado y una rica herencia histórica. Entre sus mayores iconos se encuentra el legendario Tourbillon con Tres Puentes de Oro, una obra maestra que se convirtió en símbolo de la casa.

**VINTAGE**

1945

-  Oro Rosa
-  23.5 mm
-  Cuerda Manual

PRECIO   
\$4,500





OBARRIO



REF. 25900-52-161-BAGA

**GYROMATIC**

-  Oro
-  34 mm
-  Automático

PRECIO   
\$3,500



OBARRIO



REF. 352





# GRAHAM



//// //// //// //// LONDON

Distintiva firma relojera suiza conocida por su fuerte carácter técnico y diseño audaz. Sus relojes destacan por elementos únicos como el gatillo lateral del cronógrafo, inspirado en la instrumentación aeronáutica y militar.

A lo largo de su evolución, la marca ha mantenido un enfoque en la innovación y la funcionalidad, creando piezas con gran presencia y personalidad. Graham representa ingeniería, originalidad y espíritu deportivo en la relojería contemporánea.

AARON  JOYEROS

**CHRONOFIGHTER**  
OVERSIZE SAHARA

-  Acero
-  46 mm
-  Automático



**PRECIO**   
\$3,000

-  OBARRIO
-  CAJA

REF. 2CCAU.B02A.T13N



**CHRONOFIGHTER**  
OVERSIZE

-  Acero
-  47 mm
-  Automático



**PRECIO**   
\$3,000

-  OBARRIO
-  CAJA
-  PAPELES

REF. 20VDIVAZ.B02A.K10B



**CHRONOFIGHTER**  
OVERSIZE

-  Acero
-  47 mm
-  Automático

**PRECIO**   
\$3,800

-  OBARRIO

REF. OR-20VBV-1





# GUCCI



Gucci es una influyente casa de lujo que ha extendido su creatividad al mundo de la relojería, destacándose por su enfoque en el diseño y la expresión estética. Sus relojes reflejan una identidad audaz y contemporánea, combinando moda, innovación y detalles distintivos.

A lo largo del tiempo, la marca ha desarrollado piezas que priorizan el estilo sin dejar de lado la calidad y la precisión. Gucci representa modernidad, tendencia y una visión creativa dentro del universo relojero.

AARON  JOYEROS

GUCCI



# WATCHES

- Acero
- 38 mm
- Automático

PRECIO \$1,000



REF 136.2



OBARRIO

AARON JOYEROS



★  
HAMILTON

Hamilton es una marca histórica de la relojería reconocida por combinar la precisión suiza con una fuerte herencia estadounidense, destacándose por su innovación técnica, diseños versátiles y espíritu aventurero. A lo largo de los años ha ganado prestigio en la aviación, el cine y el ámbito militar, creando relojes que equilibran funcionalidad, elegancia y rendimiento. Sus colecciones reflejan un estilo clásico con detalles contemporáneos, convirtiéndose en una referencia para quienes buscan tradición, calidad y carácter relojero.

AARON  JOYEROS

# VENTURA

## XXL BRIGHT DUNE



PAPELESCAJA



"Limited Edition"

REF.

H24614330



Acero



52 mm



Quartz

PRECIO





\$1,700

El Ventura XXL Bright Dune es una edición limitada inspirada en el reloj creado por Dune: Parte Dos, con una esfera azul luminosa que evoca los ojos de los Fremen. Su diseño futurista y detalles inspirados en la película lo convierten en una pieza imprescindible para coleccionistas y fanáticos de la saga.



D U N E

## VALIANT AUTO



-  Acero
-  40 mm
-  Automático

PRECIO   
\$700

-  OBARRIO
-  CAJA
-  PAPELES

REF. H395150



HAMILTON

# JAZZ MASTER



Acero



42 mm



Automático



CAJA

PRECIO



\$850

REF

H895450



AARON JOYEROS



OBARRIO



HARRY WINSTON

Harry Winston es una prestigiosa casa de lujo reconocida por su excelencia en alta joyería y su incursión en la alta relojería con piezas de gran sofisticación. Sus creaciones destacan por la integración de complicaciones técnicas y el uso excepcional de diamantes y gemas.

AARON  JOYEROS



HARRY WINSTON

**PROXIMAMENTE**



ORO ROSA

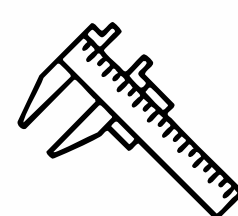

48 mm

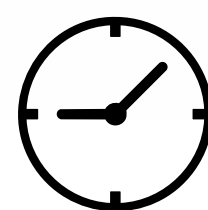

AUTOMÁTICO

PRECIO   
\$120,000

# TOURBILLON GLISSIERE



REF. 50-MATRL

**PRECIO RETAIL:**  
\$350,000

CON MANTENIMIENTO DE AGENCIA



OBARRIO



# ⌘ HUBLOT

Hublot es una innovadora manufactura suiza reconocida por su filosofía de "fusión", combinando materiales no convencionales como cerámica, carbono y caucho con la alta relojería tradicional. Sus diseños audaces y contemporáneos han redefinido el concepto de lujo deportivo.

A lo largo de su evolución, la marca ha destacado por su enfoque disruptivo y tecnológico, creando piezas de gran impacto visual y técnico. Hublot representa vanguardia, innovación y una nueva forma de entender la relojería de lujo.

**H HUBLLOT**



# KING POWER

## UEFA EURO 2012

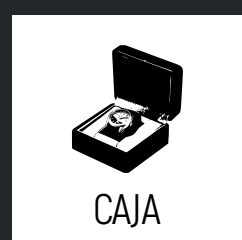

CAJA



OBARRIO



Acero



48 mm



Automático

PRECIO 

\$13,500



REF. 716.NM.1129.RX.EURO12

AARON  JOYEROS

H HUBLOT

# KING POWER



OBARRIO

ORO ROSA



48 mm



AUTOMÁTICO

PRECIO 

\$15,000



REF. 01.OQ.0180.RX



AARON  JOYEROS

## BIG BANG



- Acero
- 44 mm
- Automático

PRECIO \$7,500



OBARRIO

REF. 301.SX.130.RX

## KING POWER ÚNICO



- Titanio/Diamantes
- 48 mm
- Automático

PRECIO \$20,000



OBARRIO



PAPELES

REF. 701.NX.0170.RX.1740

## BIG BANG FERRARI



- Titanio
- 45 mm
- Automático

PRECIO \$15,500



OBARRIO

REF. 401.NQ.0123.VR

## KING POWER SAINT BARTH



- Cerámica
- 48 mm
- Automático

PRECIO \$15,000



OBARRIO

REF. HUB4200

## BIG BANG RED



- Cerámica
- 44 mm
- Automático

PRECIO \$9,500



CDE

REF. 301.CI.1130.GR.ABR10

## BIG BANG



- Carbono
- 45 mm
- Automático

PRECIO \$14,000



OBARRIO



CAJA



PAPELES

REF. 411.YT.1110.NR.IT115

## BIG BANG

Titanio/Diamantes

45 mm

Automático

PRECIO

\$12,500



OBARRIO



REF. 4j01.CX.0123.VR

## BIG BANG

Cerámica

44 mm

Automático

PRECIO

\$9,000



OBARRIO



CAJA



PAPELES



REF. 301.CT.130.RX

## BIG BANG KING POWER

Oro Rosa

48 mm

Automático

PRECIO

\$18,000



OBARRIO



CAJA



PAPELES



REF. 322.PX.100.RX

## BIG BANG BI-RETROGRADE

"KING ORO"

Cerámica/Oro Rosa

45 mm

Automático

PRECIO

\$24,200



CDE



REF. 413.OM.1128.RX

## KING POWER F1 ABU DHABI

"LIMITED EDITION"

Fibra de Carbón

48 mm

Automático

PRECIO

\$10,000



OBARRIO



CAJA



REF. 719.QM.1729.NR.FAD11

## BIG BANG CHRONOGRAPH

Oro Rosa

44 mm

Automático

PRECIO

\$17,500





OBARRIO



REF. 301.PM.1780.RX

## BIG BANG JEANS

-  Acero
-  44 mm
-  Automático

PRECIO   
\$9,800





OBARRIO



REF. 301.SX.2710.NR.JEANS

## BIG BANG

-  Acero
-  44 mm
-  Automático

PRECIO   
\$8,500



OBARRIO



REF. 301.CI.2770.NR

## MDN GENEVE

-  Oro Amarillo
-  36 mm
-  Quartz

PRECIO   
\$6,500



OBARRIO



CAJA



PAPELES



REF. 1512.100.3

## MDN TEDDY BEAR

-  Acero
-  26 mm
-  Quartz

PRECIO   
\$2,000



OBARRIO



CAJA





PAPELES



REF. 1392.999.3

## BIG BANG BLACK DIAL

-  Cerámica
-  44 mm
-  Automático

PRECIO   
\$6,800





OBARRIO



REF. 301.CM.130.RX

## SUPER B

-  Oro Rosa
-  42 mm
-  Automático

PRECIO   
\$20,000



OBARRIO



REF. 1920.8

## BIG BANG KING POWER

- Acero
- 44 mm
- Automático

PRECIO   
\$9,500



OBARRIO



REF. 701.CI.1123.GR

## BIG BANG

- Acero
- 38 mm
- Quartz

PRECIO   
\$7,500



OBARRIO



REF. 361.SX.7170.LR.1204

## BIG BANG KING POWER F1

- Fibra de Carbono
- 48 mm
- Automático

PRECIO   
\$11,000



OBARRIO



CAJA



PAPELES



REF. 703.QM.1129.HR.FIL11

## BIG BANG KING POWER F1

- Oro Rosa
- 48 mm
- Automático

PRECIO   
\$21,000



OBARRIO



CAJA



PAPELES



REF. 703.OM.1138.NR.FM010

## BIG BANG

- Oro Rosa/Titanio
- 45 mm
- Automático

PRECIO   
\$19.500



OBARRIO



CAJA



REF. 614.OX.1180.RX

## BIG BANG

- Oro Rosa
- 41 mm
- Automático

PRECIO   
\$18,000



OBARRIO





REF. 341.PT.5010.LR.1104

## CLASSIC FUSION

- Acero
- 42 mm
- Automático

PRECIO   
\$6,000

-  OBARRIO
-  CAJA
-  PAPELES



REF. 542.NX.1270.RX

## CLASSIC FUSION

- Titanio
- 45 mm
- Automático

PRECIO   
\$5,700

-  OBARRIO



REF. 511.NX.1170.LR

## BIG BANG

- Acero
- 44 mm
- Automático

PRECIO   
\$7,500

-  OBARRIO



REF. 301SX.1170.RX

## CLASSIC FUSION

- Titanio
- 42 mm
- Automático

PRECIO   
\$6,000

-  OBARRIO



REF. 542.NX.8970.RX





# IWC

## SCHAFFHAUSEN

IWC Schaffhausen es una reconocida manufactura suiza que destaca por su ingeniería de precisión y diseño funcional con influencia técnica. Sus relojes, especialmente en líneas como Pilot's Watches y Portugieser, reflejan un enfoque claro en la legibilidad, la robustez y la elegancia.

A lo largo de su historia, la marca ha combinado tradición relojera con innovación mecánica, consolidándose como referente en relojería técnica. IWC representa precisión, fiabilidad y sofisticación en la alta relojería.

## INGENIEUR

-  Cerámica
-  46 mm
-  Automático

PRECIO   
\$5,500





OBARRIO



REF. IW322504

## AQUATIMER

-  Acero
-  46.6 mm
-  Automático

PRECIO   
\$4,200





OBARRIO



REF. IW376709

## AVIADOR

-  Acero
-  46.2 mm
-  Automático

PRECIO   
\$7,000



OBARRIO



CAJA





PAPELES



REF. IW50100

## PORTUGIESER YACHT CLUB

-  Acero
-  44 mm
-  Automático

PRECIO   
\$7,800





OBARRIO



REF. W390503

## AQUATIMER EDICIÓN GALÁPAGOS

"CHARLES DARWING"

-  Acero
-  44 mm
-  Automático

PRECIO   
\$4,000





OBARRIO



REF. W376705

## AQUATIMER

-  Oro Rosa
-  44 mm
-  Automático

PRECIO   
\$20,000



OBARRIO



CAJA



PAPELES



REF. W376905





**JAEGER-LECOULTRE**

Jaeger-LeCoultre es una histórica manufactura suiza reconocida por su excelencia técnica, innovación y dominio en la creación de calibres propios. Sus relojes, como el icónico Reverso, reflejan una perfecta fusión entre ingeniería y elegancia atemporal.

A lo largo de su trayectoria, la marca ha desarrollado numerosas complicaciones y avances en la relojería. Jaeger-LeCoultre representa tradición, precisión y maestría dentro de la alta relojería suiza.

**AARON**  **JOYEROS**

**MASTER  
CALENDAR**

-  Oro Rosa
-  39 mm
-  Automático

**PRECIO**   
**\$14,000**





OBARRIO



REF. 176.2.12.S

**RENDEZ-VOUS**

-  Acero
-  34 mm
-  Automático

**PRECIO**   
**\$7,000**



OBARRIO



REF. 344.8.37







# LONGINES

Longines es una histórica casa suiza destacada por su elegancia, precisión y tradición relojera. Sus diseños reflejan un estilo clásico y atemporal que ha perdurado a lo largo del tiempo.

Longines representa fiabilidad, refinamiento y herencia dentro de la relojería suiza.

AARON  JOYEROS

## CONQUEST

-  Acero
-  44.5 mm
-  Automático

PRECIO   
\$2,000





OBARRIO



REF. L3.697.4

## VINTAGE

-  Oro Amarillo
-  24 mm
-  Automático

PRECIO   
\$9,400



CDE



CAJA





PAPELES



REF. 26310R.00

## LEGEND DIVER

-  Acero
-  42 mm
-  Automático

PRECIO   
\$2,200





OBARRIO



REF. L3.774.4.50.9

## EVIDENZA

-  Acero
-  38.75 mm
-  Automático

PRECIO   
\$1,500





OBARRIO



REF. L2.642.4.51.6

## SAINT-IMIER

-  Oro
-  36.8 mm
-  Automático

PRECIO   
\$5,600





OBARRIO



REF. L.989.2

## MASTER COLLECTION

"Pulso Aftermarket"

-  Acero
-  42 mm
-  Automático

PRECIO   
\$1,600





OBARRIO





REF. 26664783

## HERITAGE AVIGATION BIG EYE

-  Titanio
-  41 mm
-  Automático



PRECIO   
\$3,200

-  OBARRIO
-  CAJA
-  PAPELES



REF. L2.816.1



## SPIRIT

-  Acero
-  37 mm
-  Automático



PRECIO   
\$2,400

-  OBARRIO
-  CAJA
-  PAPELES

REF. L3.410.4.93.6



## MASTER COLLECTION MOONPHASE CHRONOGRAPH

-  ACERO
-  40 mm
-  AUTOMÁTICO

PRECIO  
\$2,000

-  OBARRIO

REF. L2.673.4.78.3





**MONT  
BLANC** 

Montblanc es una distinguida casa de lujo que ha incursionado en la alta relojería combinando precisión suiza con diseño elegante y contemporáneo. Sus relojes reflejan un equilibrio entre tradición, innovación y estética refinada.

Montblanc representa sofisticación, funcionalidad y una visión moderna dentro del universo relojero.

AARON  JOYEROS

MONT  
BLANC

# TIMEWALKER



ACERO



43 mm



AUTOMÁTICO

PRECIO



\$2,200



REF.

7069



OBARRIO

AARON  JOYEROS

## PRINCESS GRACE DE MÓNACO

- Acero
- 34 mm
- Quartz

PRECIO   
\$1,500

- OBARRIO
- CAJA



REF. 106884

## TIMEWALKER

- Acero
- 39 mm
- Automático

PRECIO   
\$1,800

- OBARRIO
- CAJA
- PAPELES



REF. 7308

## MONTBLANC

- Acero
- 41 mm
- Automático

PRECIO   
\$3,500

- OBARRIO



REF. 7383

## TIMEWALKER

- Acero
- 42 mm
- Automático

PRECIO   
\$1,200

- CDE



REF. 7070

## TIMEWALKER

- Acero
- 42 mm
- Automático

PRECIO   
\$1,500

- OBARRIO
- CAJA



REF. 4810

## STAR

- Acero
- 40 mm
- Quartz



PRECIO   
\$1,400

- OBARRIO



REF. MB104182

## TIMEWALKER OROLOGIO

-  Acero
-  43 mm
-  Automático

PRECIO   
\$1,600





OBARRIO



REF. 0969

## MEINSTERSTUCK

-  Acero
-  42 mm
-  Automático

PRECIO   
\$1,500



OBARRIO





CAJA



REF. 7070

## MEINSTERSTUCK

-  Acero
-  43 mm
-  Automático

PRECIO   
\$2,000



OBARRIO



REF. 7141

## STUCK

-  Acero
-  36 mm
-  Quartz

PRECIO   
\$1,200





OBARRIO



REF. 7038

## TIMEWALKER GMT

-  Acero
-  42 mm
-  Automático

PRECIO   
\$2,000





OBARRIO



REF. 7081

## STAR

-  Acero
-  42 mm
-  Automático

PRECIO   
\$2,500





OBARRIO



REF. 110642

## MONTBLANC



-  Acero
-  41 mm
-  Automático

PRECIO   
\$1,500



OBARRIO



REF. 4810



## MONTBLANC

1858



-  Acero
-  42 mm
-  Automático

PRECIO   
\$2,200



OBARRIO



CAJA





PAPELES

REF. 1858



## SPORT



-  Acero
-  41 mm
-  Automático

PRECIO   
\$1,500



OBARRIO

REF. 7034





# MAURICE LACROIX

Manufacture Horlogère Suisse

Maurice Lacroix es una casa suiza que destaca por su enfoque en el diseño contemporáneo y la innovación accesible dentro de la relojería. Sus creaciones combinan precisión, estética moderna y un fuerte carácter visual.

Maurice Lacroix representa creatividad, dinamismo y una propuesta actual en la relojería suiza.



ORO AMARILLO



46 mm

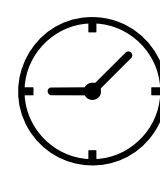

AUTOMÁTICO

PRECIO 

\$19,000



OBARRIO

**MASTERPIECE**

REF.

MP7281





# MASTERPIECE

ORO AMARILLO 18K



40 mm

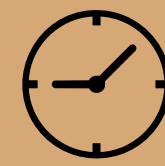

AUTOMÁTICO

PRECIO 

\$17,000



OBARRIO

REF.

MP6388



# Ω OMEGA

Omega es una prestigiosa marca suiza de relojería fundada en 1848, reconocida por su precisión, innovación y fuerte legado histórico. Es famosa por hitos como el Apollo 11 Moon Landing, donde su modelo Speedmaster fue el primer reloj en la Luna, y por ser cronómetro oficial de los Juegos Olímpicos.

Hoy, Omega representa lujo, tecnología avanzada y diseño icónico dentro de la alta relojería.

SEAMASTER

SPEEDMASTER

CONSTELLATION

DE VILLE

DYNAMIC



OBARRIO



Oro Amarillo



41 mm



Automático

PRECIO



\$33,300

REF. 2134.80.00

REF.

SEAMASTER



45.5 mm



AUTOMÁTICO



OBARRIO

# SEAMASTER

PRECIO   
\$8,000

TITANIO

REF. 215.90.46.51.99.001



CAJA



PAPELES



SEAMASTER

SPEEDMASTER

CONSTELLATION

DE VILLE

DYNAMIC

## SEAMASTER PLANET OCEAN

"PANAMA CANAL"

- Acero
- 45.5 mm
- Automático

PRECIO   
\$6,000



OBARRIO



REF. 232.30.46.21.01.005



## SEAMASTER PLANET OCEAN

- Cerámica
- 45.5 mm
- Automático

PRECIO   
\$8,500



OBARRIO



REF. 215.92.22.01.004



## SEAMASTER 300

- Acero
- 45.5 mm
- Automático

PRECIO   
\$5,800



OBARRIO



REF. 234.30.41.21.03.001



SEAMASTER      SPEEDMASTER      CONSTELLATION      DE VILLE      DYNAMIC

## SEAMASTER

- Acero
- 36 mm
- Automático

PRECIO \$  
\$2,500



OBARRIO



REF. 2551.80

## SEAMASTER PLANET OCEAN 600M

- Acero
- 43.5 mm
- Automático

PRECIO \$  
\$5,000



OBARRIO



CAJA



PAPELES



REF. 232.30.44.22.01.001

## SEAMASTER

- Acero
- 36 mm
- Quartz

PRECIO \$  
\$2,000



OBARRIO



REF. 2561.80.00

## SEAMASTER 300M

- Acero
- 36 mm
- Automático

PRECIO \$  
\$2,600



OBARRIO



REF. 22228000

## SEAMASTER

- Acero
- 36 mm
- Quartz

PRECIO \$  
\$2,000



OBARRIO



REF. 2561.80.00

## SEAMASTER

- Acero
- 36 mm
- Quartz

PRECIO \$  
\$2,000





OBARRIO



REF. 2561.80.00

SEAMASTER      SPEEDMASTER      CONSTELLATION      DE VILLE      DYNAMIC

## SEAMASTER AQUA TERRA

-  Acero
-  43 mm
-  Automático

PRECIO   
\$4,500





CDE



REF. 231.10.44.50.02.001

## SEAMASTER

-  Acero
-  34 mm
-  Automático

PRECIO   
\$3,500



OBARRIO





CAJA



REF. 166.0217

## SEAMASTER

-  ACERO
-  mm
-  AUTOMÁTICO

PRECIO  
\$1,800



OBARRIO



REF. 2561.80.00

SEAMASTER

SPEEDMASTER

CONSTELLATION

DE VILLE

DYNAMIC

## SPEEDMASTER MOONPHASE

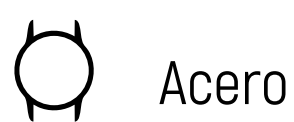

Acero

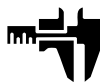

44.2 mm



Automático

PRECIO

\$8,500



OBARRIO



REF. 304.33.44.52.03.001

## SPEEDMASTER



Cerámica/Nato



42.2 mm



Automático

PRECIO

\$8,500



OBARRIO





REF. 311.92.44.51.01.007





SEAMASTER	SPEEDMASTER	CONSTELLATION	DE VILLE	DYNAMIC
-----------	-------------	---------------	----------	---------

## CONSTELLATION

-  Acero / Oro Rosa
-  35 mm
-  Automático

PRECIO   
\$6,500

-  OBARRIO
-  CAJA
-  PAPELES



REF. 23.20.35.20.63.001

## CONSTELLATION BICOLOR

-  Acero y Oro
-  38 mm
-  Automático



PRECIO   
\$8,000

-  OBARRIO
-  CAJA
-  PAPELES



REF. 123.20.38.21.03.001

## CONSTELLATION BICOLOR

-  Acero y Oro
-  34 mm
-  Quartz

PRECIO   
\$2,500

-  OBARRIO



REF. 55296372

## CONSTELLATION MOTHER OF PEARL

-  Acero y Oro
-  24 mm
-  Quartz

PRECIO   
\$1,800

-  CDE



REF. 795.1203

## CONSTELLATION

-  Acero / Oro
-  29 mm
-  Automático

PRECIO   
\$9,800

-  OBARRIO



REF. 31.20.29.20.05.002

## CONSTELLATION

-  Acero / Oro
-  35.5 mm
-  Quartz

PRECIO   
\$2,800

-  OBARRIO





REF. 302.30.00

SEAMASTER      SPEEDMASTER      CONSTELLATION      DE VILLE      DYNAMIC

## CONSTELLATION QUADRA

"DIAL MADRE PERLA"

-  Acero
-  24 X 19.3 mm
-  Quartz

PRECIO   
\$1,400



OBARRIO



REF. 1521.7100

## CONSTELLATION

-  Acero
-  27 mm
-  Quartz

PRECIO   
\$2,500



OBARRIO



CAJA





PAPELES



REF. 123.10.27.60.02.002

## CONSTELLATION QUADRA DIAMOND

-  Acero / Diamante
-  19 mm
-  Quartz

PRECIO   
\$2,000



OBARRIO



REF. 1528.76.00

## CONSTELLATION

-  Acero / Oro
-  35 mm
-  Quartz

PRECIO   
\$2,500



OBARRIO



PAPELES



REF. 1212.30.00

## CONSTELLATION QUADRA DIAMOND

-  Acero
-  19 mm
-  Quartz

PRECIO   
\$1,200





OBARRIO



REF. 1528.76.00

## CONSTELLATION

-  Oro Amarillo
-  35 mm
-  Automático

PRECIO   
\$4,000



OBARRIO





REF. 2853

SEAMASTER      SPEEDMASTER      CONSTELLATION      DE VILLE      DYNAMIC

## DEVILLE VINTAGE

"BISEL DE DIAMANTES"

-  Oro Blanco
-  25.4 mm
-  Quartz

PRECIO   
\$8,000





OBARRIO



REF. VINTAGE

## DE VILLE

-  Acero
-  41 mm
-  Automático

PRECIO   
\$3,500



OBARRIO





CAJA



REF. 424.10.37.20.03.001

## DE VILLE PRESTIGE

-  Acero
-  39.5 mm
-  Automático

PRECIO   
\$3,500



OBARRIO





CAJA



REF. 424.13.40.20.06.002

## DE VILLE

-  Acero / Oro Ama.
-  36.8 mm
-  Automático

PRECIO   
\$4,000



OBARRIO



REF. 424.20.37.20.02.001

## DE VILLE

-  Oro Amarillo
-  31 mm
-  Quartz

PRECIO   
\$4,000





OBARRIO



VINTAGE

## DE VILLE

"UFO"

-  Acero
-  40 mm
-  Automático

PRECIO   
\$1,200



OBARRIO



166.094

SEAMASTER

SPEEDMASTER

CONSTELLATION

DE VILLE

DYNAMIC

## DE VILLE

 Acero / Oro

 25 mm

 Automático

PRECIO 

\$1,000



OBARRIO



REF. DA 796.2379

## DE VILLE

 Oro Amarillo

 37.5 mm

 Automático

PRECIO 

\$30,500



OBARRIO



REF. 4131.31.00



SEAMASTER



SPEEDMASTER

CONSTELLATION

DE VILLE

DYNAMIC

## DYNAMIC

-  Acero
-  42 mm
-  Automático

PRECIO   
\$1,200



OBARRIO



REF. 136.033





**ORIS**  
HÖLSTEIN 1904

Oris es una marca suiza independiente fundada en 1904, reconocida por su enfoque en relojes mecánicos accesibles. Especializada exclusivamente en movimientos automáticos.

Oris ha ganado notoriedad por desarrollar calibres propios como la serie Calibre 400 con alta reserva de marcha.

La marca mantiene una filosofía de "lujo funcional", priorizando utilidad sobre ostentación.

AARON  JOYEROS

# BIG CROWN



ACERO

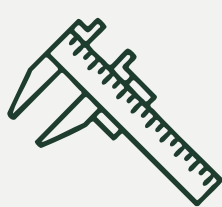

44 mm

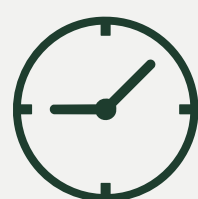

AUTOMÁTICO

PRECIO



\$1,600

REF.

7629-40



OBARRIO



**REGULATEUR**



**DER MEISTERTAUCHER**

TITANIO



49 mm



AUTOMÁTICO



CAJABARRIO



PAPELES

PRECIO 

\$1,500

REF.

01 649 7610





# PANERAI



Panerai es una distintiva casa de relojería con raíces italianas y desarrollo suizo, reconocida por su diseño robusto y estética inconfundible. Sus relojes, inspirados en instrumentos militares y de buceo, destacan por cajas imponentes y alta legibilidad.

A lo largo de su historia, la marca ha combinado ingeniería técnica con un estilo único. Panerai representa carácter, herencia y presencia dentro de la relojería de lujo.

## FERRARI CRONÓGRAFO

-  Acero
-  45 mm
-  Automático



PRECIO   
\$6,500

-  OBARRIO
-  CAJA
-  PAPELES



REF. FER00004

## FERRARI CRONÓGRAFO

-  Acero
-  45 mm
-  Automático



PRECIO   
\$6,500

-  CDE





REF. FER00005

## MARINA MILITARE

-  Acero
-  47 mm
-  Automático

PRECIO   
\$9,500

-  OBARRIO
-  CAJA
-  PAPELES



REF. PAM673

## RADIOMIR BLACK SEAL

-  Acero
-  45 mm
-  Cuerda Manual



PRECIO   
\$4,200

-  OBARRIO



REF. PAM00183

## LUMINOR BLACK SEAL

-  Acero
-  47 mm
-  Automático

PRECIO   
\$5,500

-  OBARRIO



REF. PAM0514

## LUMINOR

-  Acero
-  44 mm
-  Cuerda Manual



PRECIO   
\$3,900

-  OBARRIO



REF. PAM112

## LUMINOR RATTRAPANTE



-  Acero
-  44 mm
-  Automático

PRECIO   
\$7,300



REF. PAM00213

## RADIOMIR MILITARE



-  Cerámica
-  47 mm
-  Automático

PRECIO   
\$9,000



REF. PAM00339

## LUMINOR



-  Acero
-  44 mm
-  Automático

PRECIO   
\$4,400



REF. OP6728

## LUMINOR SUMERSIBLE



-  Acero
-  47 mm
-  Automático

PRECIO   
\$7,000



REF. PAM00305

## SUBMERSIBLE



-  Acero
-  42 mm
-  Automático

PRECIO   
\$7,500



REF. PAM00959

## LUMINOR

-  Acero / Caucho
-  47 mm
-  Automático

PRECIO   
\$6,000



REF. PAM372



**CHARRIOL**  
GENEVE

Philippe Charriol es una firma de lujo reconocida por su enfoque distintivo en el diseño, inspirado en formas y trenzados característicos. Sus relojes combinan elegancia, creatividad y una identidad visual única dentro del mundo relojero.

A lo largo de su trayectoria, la marca ha desarrollado piezas con fuerte personalidad estética representando estilo, originalidad y sofisticación contemporánea.

**AARON**  **JOYEROS**

## CHARRIOL

 Acero/Baño de Oro

 33.5 mm

 Quartz

PRECIO 

\$1,000



OBARRIO



REF. 53.98.3797





# PIAGET

Philippe Charriol es una firma de lujo reconocida por su enfoque distintivo en el diseño, inspirado en formas y trenzados característicos. Sus relojes combinan elegancia, creatividad y una identidad visual única dentro del mundo relojero.

A lo largo de su trayectoria, la marca ha desarrollado piezas con fuerte personalidad estética. Philippe Charriol representa estilo, originalidad y sofisticación contemporánea.

## POSSESSION

 Oro Blanco

 28 mm

 Quartz

PRECIO   
\$5,000



OBARRIO



CAJA



PAPELES



REF. 1009275

## ALTIPLANO CLOUS DE PARÍS

 Oro 18 k

 26 mm

 Cuerda Manual

PRECIO   
\$4,000





OBARRIO



REF. 549551

## HABANA CUERVOS Y SOBRINOS

 Acero y Oro Ama.

 33 mm

 Cuerda Manual

PRECIO   
\$700





OBARRIO



REF. 26310R.00

## MISS PROTOCOLE XL

-  Bisel/Diamante
-  40 x 36 mm
-  Quartz

PRECIO   
\$8,500



CDE



REF. P10206

## POLO

-  Oro y Diamantes
-  34 mm
-  Automático

PRECIO   
\$20,000



OBARRIO



REF. 24005 M 501 D

## RECTANGLE L'ANTIGUA XL

-  Oro Rosa
-  31 X 46 mm
-  Automático

PRECIO   
\$15,200





CDE



REF. PI0076

## TANAGRA

-  Oro Amarillo
-  24 mm
-  Quartz

PRECIO   
\$11,850



CDE



REF. 16033





**RW**  
**RAYMOND WEIL**  
GENEVE



Raymond Weil es una reconocida casa suiza que destaca por su elegancia accesible y su inspiración en la música y las artes. Sus relojes combinan diseño clásico, precisión y un enfoque estético refinado.

A lo largo de su trayectoria, la marca ha creado colecciones con fuerte identidad cultural. Raymond Weil representa armonía, tradición y estilo dentro de la relojería suiza.

**ELECTROPLATED  
 VINTAGE**



REF. 9022

-  Baño de Oro
-  28 mm
-  Quartz

PRECIO   
 \$500





OBARRIO

**NABUCCO**



REF. 3900

-  Acero
-  44 mm
-  Automático

PRECIO   
 \$600



OBARRIO





CAJA



**DON GIOVANNI  
 COSI GRANDE**



REF. 2671-ST-00209

-  Acero
-  29.5 x 31 mm
-  Quartz

PRECIO   
 \$1,200



OBARRIO

**TOCCATA  
 CLASSIC**



REF. 5585-ST-60001

-  Acero
-  42 mm
-  Quartz

PRECIO   
 \$900



OBARRIO



CAJA



PAPELES



**TANGO**



REF. 8260-ST7-20001

-  Acero
-  41 mm
-  Quartz

PRECIO   
 \$750



OBARRIO



**REVIEW THOMMEN**



Since 1853

La línea de Revue Thommen refleja una sólida tradición relojera suiza, enfocada en la precisión y la funcionalidad. Sus diseños equilibran lo clásico y lo deportivo, con una estética sobria y versátil.

Con una historia ligada también a la aviación y a instrumentos de medición, la marca transmite fiabilidad técnica en cada pieza. Es una opción atractiva para quienes buscan relojes mecánicos bien contruidos, elegantes y con carácter histórico.

**AARON**  **JOYEROS**

## REVUE THOMMEN

-  Acero
-  40 mm
-  Automático



PRECIO   
\$1,000



CDE



CAJA



PAPELES

REF.

7001.6





## ROGER DUBUIS

Roger Dubuis es una audaz manufactura suiza de alta relojería, reconocida por su diseño vanguardista y complejidad mecánica. Sus relojes destacan por esqueletizados extremos, arquitectura contemporánea y acabados de alto nivel.

A lo largo de su evolución, la marca ha llevado la relojería a un terreno más expresivo y disruptivo. Roger Dubuis representa innovación, exclusividad y una visión radical del lujo relojero.



ROGER DUBUIS



# PULSION

ORO ROSA

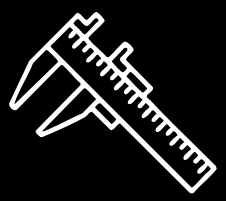

44 mm

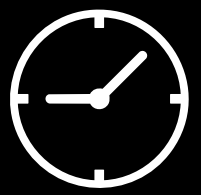

AUTOMÁTICO

PRECIO

\$25,000

**PRECIO RETAIL:**  
\$43,900

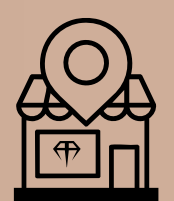

OBARRIO

REF.

RDDDBPU003

AARON JOYEROS



# ROLEX

Rolex es una de las marcas más reconocidas de la alta relojería, famosa por su precisión, durabilidad y diseño atemporal. Sus colecciones combinan innovación técnica con elegancia, convirtiéndose en símbolo de éxito, prestigio y rendimiento en cualquier entorno.

AARON  JOYEROS

AIR KING	DAYTONA	DATEJUST	DAY-DATE	EXPLORER	GMT-MASTER	MILGAUSS
OYSTER PERPETUAL	SEA-DWELLER	SKY-DWELLER	SUBMARINER	YACHT-MASTER	CELLINI	

# AIR KING



-  Acero
-  34 mm
-  Automático

 CDE

**PRECIO** 

**\$4,000**

"AFTERMARKET DIAL" REF. 15210

AIR KING	DAYTONA	DATEJUST	DAY-DATE	EXPLORER	GMT-MASTER	MILGAUSS
OYSTER PERPETUAL	SEA-DWELLER	SKY-DWELLER	SUBMARINER	YACHT-MASTER	CELLINI	

# AIRKING PRECISION



-  Acero
-  34 mm
-  Automático

PRECIO   
\$4,800



OBARRIO

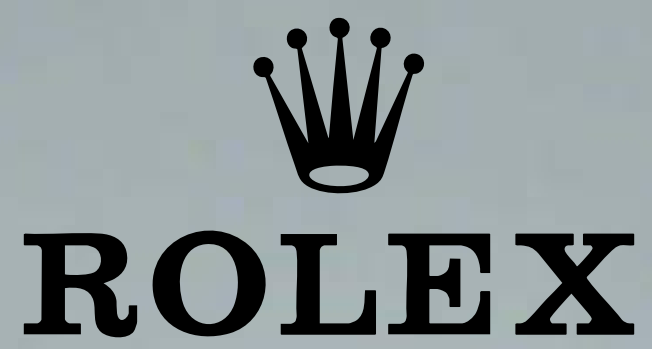

# DAYTONA

La línea Daytona es un icono de la relojería deportiva, creada para el automovilismo y la medición precisa del tiempo. Con su característico bisel taquimétrico y diseño elegante, combina alto rendimiento con lujo, consolidándose como uno de los modelos más deseados de Rolex.

# DAYTONA

## COSMOGRAPH

**DAYTONA**  
JOHN MAYER



OBARRIO

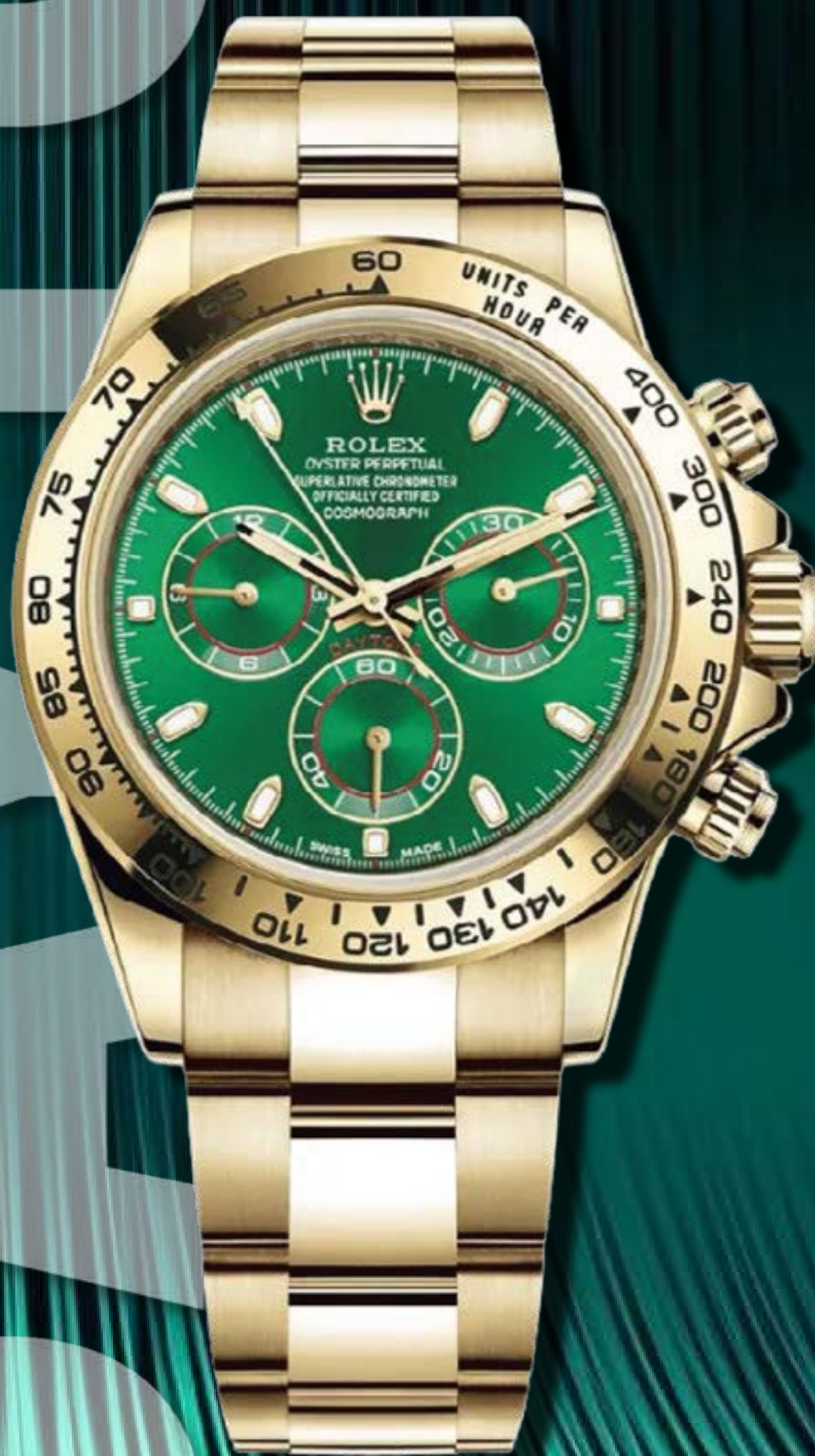

 Oro Amarillo

 40 mm

 Automático

PRECIO   
\$75,000

REF.

  
**ROLEX**

# DAYTONA

COSMOGRAPH

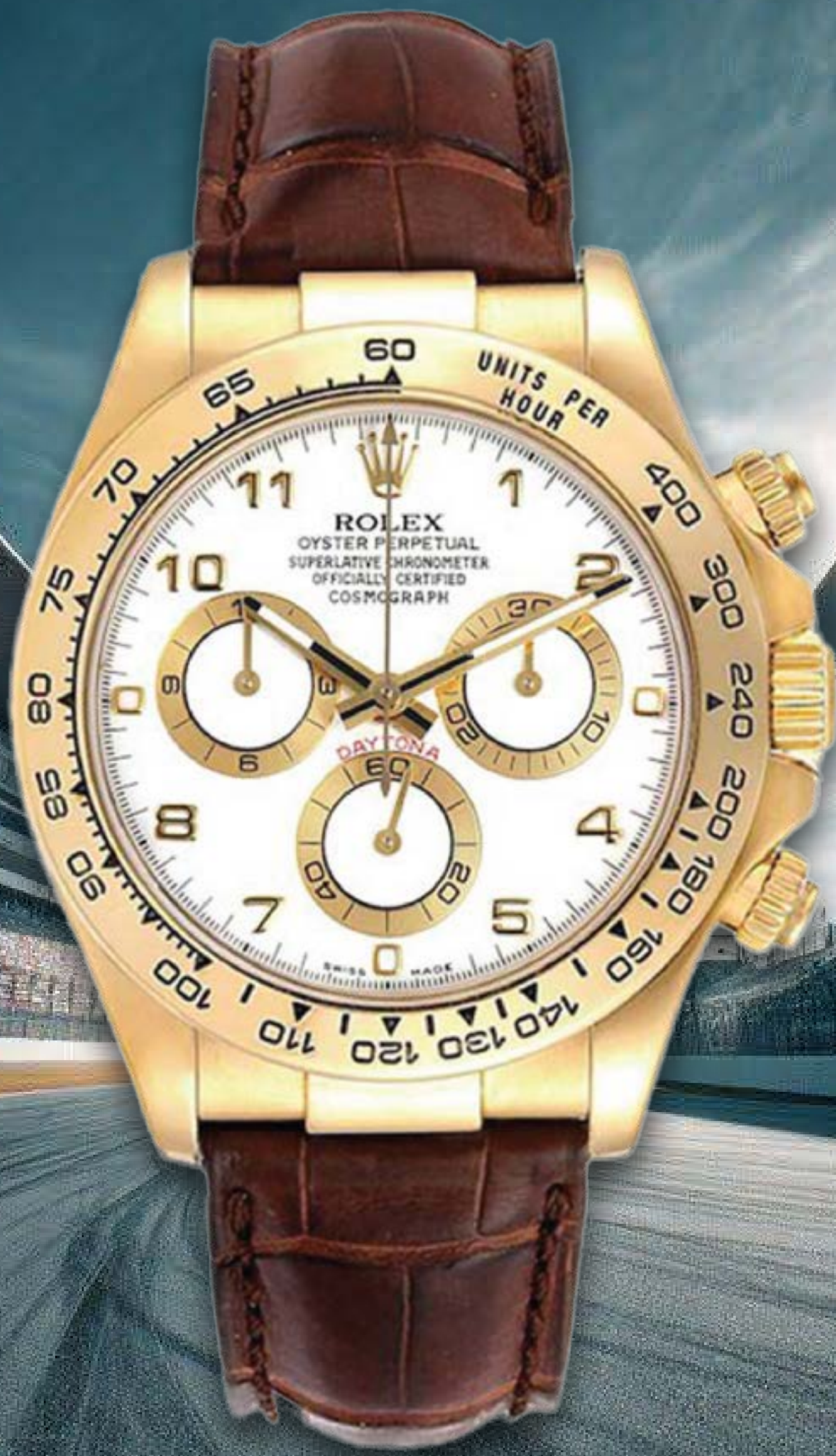

COSTA DEL ESTE



ORO



40 mm



AUTOMÁTICO

PRECIO



\$35,000

116518

REF.

AARON  JOYEROS

AIR KING	DAYTONA	DATEJUST	DAY-DATE	EXPLORER	GMT-MASTER	MILGAUSS
OYSTER PERPETUAL	SEA-DWELLER	SKY-DWELLER	SUBMARINER	YACHT-MASTER	CELLINI	

**DAYTONA**  
COSMOGRAPH



REF. 116520

- Acero
- 40 mm
- Automático

PRECIO \$24,000



COSTA DEL ESTE CAJA

**DAYTONA**



REF. 116523

- Acero / Oro
- 40 mm
- Automático

PRECIO \$21,000



COSTA DEL ESTE CAJA

**DAYTONA**

"INVERTED 6"



REF. 16523

- Acero / Oro
- 40 mm
- Automático

PRECIO \$22,000



COSTA DEL ESTE

**DAYTONA**



REF. 116528

- Oro
- 40 mm
- Automático

PRECIO \$35,000



OBARRIO CAJA

**DAYTONA**  
OYSTER FLEX



REF. 16518

- Oro
- 40 mm
- Automático

PRECIO \$30,000



OBARRIO CAJA PAPELES

**DAYTONA**

"MOVIMIENTO ZENITH"



REF. 16523

- Acero / Oro
- 40 mm
- Automático

PRECIO \$19,500



OBARRIO

AIR KING	DAYTONA	DATEJUST	DAY-DATE	EXPLORER	GMT-MASTER	MILGAUSS
OYSTER PERPETUAL	SEA-DWELLER	SKY-DWELLER	SUBMARINER	YACHT-MASTER	CELLINI	

**DAYTONA**



REF. 116520

- Acero
- 40 mm
- Automático

PRECIO \$23,000



**DAYTONA**



REF. 116509

- Oro Blanco
- 40 mm
- Automático

PRECIO \$35,000

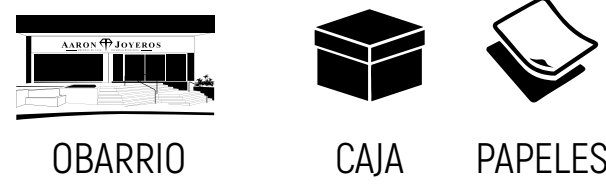

**DAYTONA**



REF. 116520

- Acero
- 40 mm
- Automático

PRECIO \$22,500



**DAYTONA**



REF. 116520

- Acero
- 40 mm
- Automático

PRECIO \$23,000



**DAYTONA**

"NUEVO A ESTRENAR"

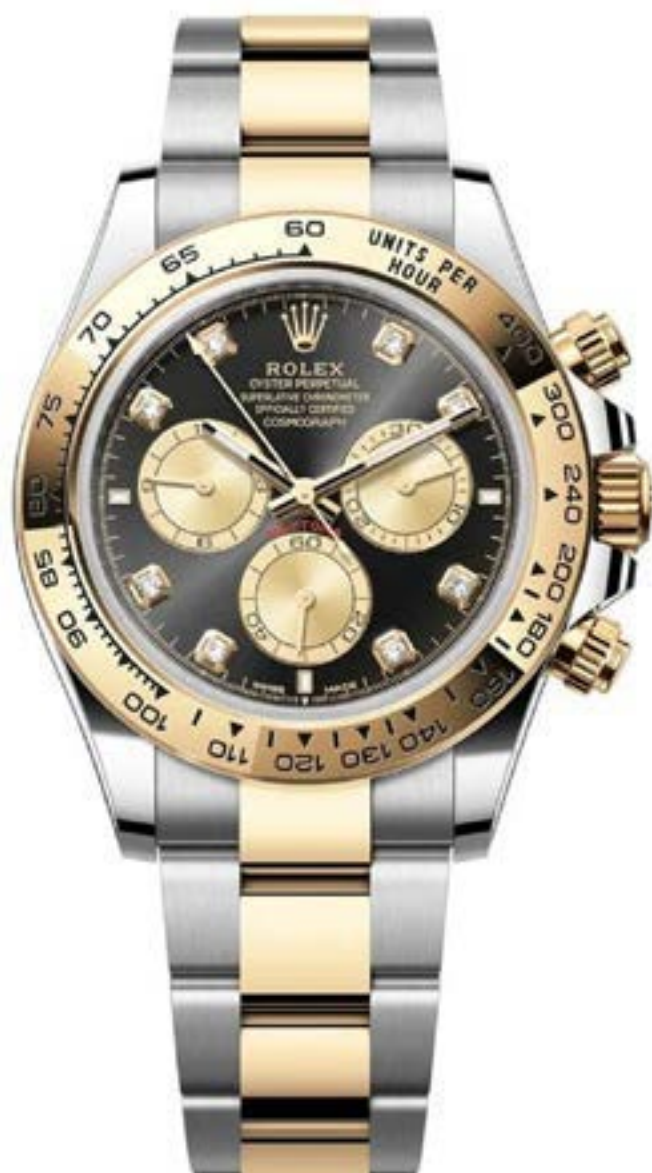

REF. 126503

- Acero / Oro
- 40 mm
- Automático

PRECIO \$33,500

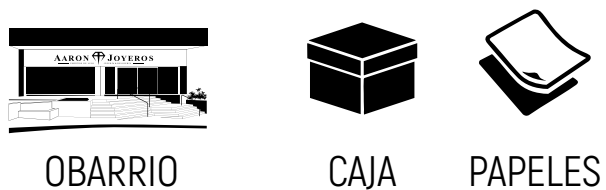

# WIMBLEDON

## DATEJUST



 Acero / Oro

 41 mm

 Automático



REF 126333

REF

PRECIO   
\$16,500





CAJA



PAPELES

AIR KING	DAYTONA	DATEJUST	DAY-DATE	EXPLORER	GMT-MASTER	MILGAUSS
OYSTER PERPETUAL	SEA-DWELLER	SKY-DWELLER	SUBMARINER	YACHT-MASTER	CELLINI	

## DATEJUST WIMBLEDON

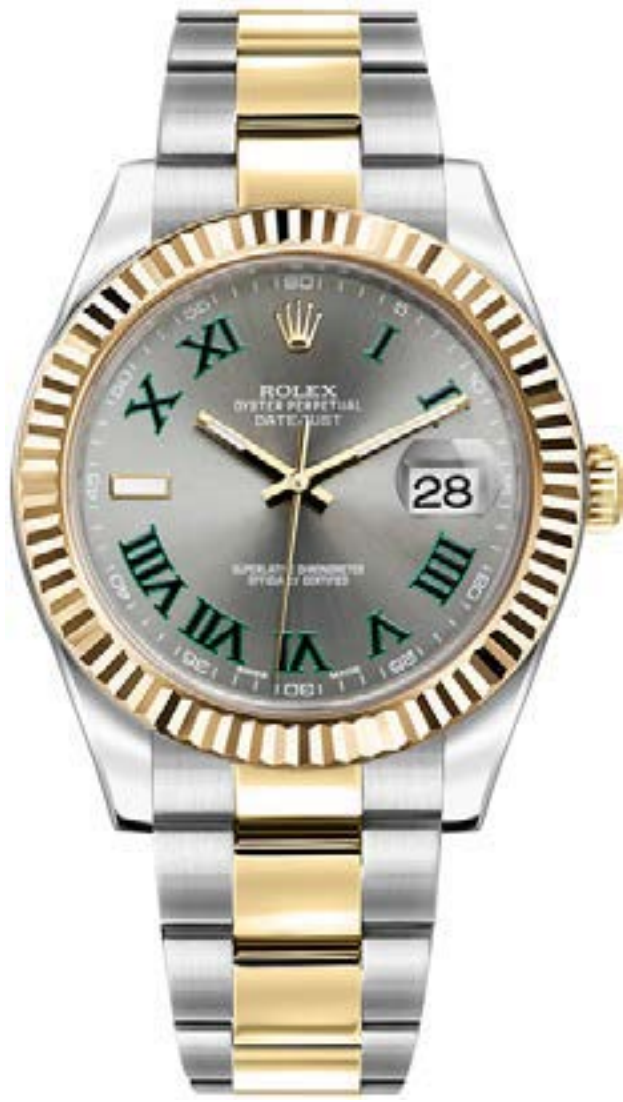

-  Acero / Oro
-  41 mm
-  Automático

PRECIO   
\$13,500



REF. 16333

## DATEJUST WIMBLEDON

-  Acero / Oro
-  41 mm
-  Automático



PRECIO   
\$15,500



REF. 126303



## DATEJUST WIMBLEDON

-  Acero / Oro
-  41 mm
-  Automático



PRECIO   
\$14,000



REF. 126333



## DATEJUST WIMBLEDON

-  Acero / Oro
-  41 mm
-  Automático

PRECIO   
\$13,800



REF. 116333

# DATEJUST PEARLMASTER



-  Oro Rosa
-  34 mm
-  Automático

PRECIO   
\$37,000

"FONDO MADRE PERRLA"



 CAJA  PAPELES

REF. 81315



OBARRIO

AIR KING	DAYTONA	DATEJUST	DAY-DATE	EXPLORER	GMT-MASTER	MILGAUSS
OYSTER PERPETUAL	SEA-DWELLER	SKY-DWELLER	SUBMARINER	YACHT-MASTER	CELLINI	

**DATEJUST**

"BISEL DE ORO"

- Acero / Oro
- 41 mm
- Automático

PRECIO   
\$11,000



CDE



REF. 116334

**DATEJUST**

"BISEL DE ORO"

- Acero / Oro
- 41 mm
- Automático

PRECIO   
\$11,000



OBARRIO



REF. 116334

**DATEJUST**

- Acero / Oro
- 41 mm
- Automático

PRECIO   
\$11,000



OBARRIO



REF. 116334

**DATEJUST**

- Acero
- 41 mm
- Automático

PRECIO   
\$10,000



OBARRIO



REF. 126300

**DATEJUST**

- Oro
- 36 mm
- Automático

PRECIO   
\$12,000



OBARRIO



REF. 116139

**DATEJUST**

- Oro Amarillo
- 36 mm
- Automático

PRECIO   
\$15,000





OBARRIO



REF. 1601

AIR KING	DAYTONA	DATEJUST	DAY-DATE	EXPLORER	GMT-MASTER	MILGAUSS
OYSTER PERPETUAL	SEA-DWELLER	SKY-DWELLER	SUBMARINER	YACHT-MASTER	CELLINI	

## DATEJUST

-  Acero
-  41 mm
-  Automático

PRECIO   
\$9,500





OBARRIO



REF. 116300

## DATEJUST

-  Acero
-  41 mm
-  Automático

PRECIO   
\$10,500



OBARRIO



CAJA





PAPELES



REF. 116300



## DATEJUST

-  ACERO / ORO
-  36 mm
-  AUTOMÁTICO

PRECIO  
\$7,500





OBARRIO



REF. 16013

## DATEJUST

-  Acero
-  36 mm
-  Automático

PRECIO   
\$5,500





OBARRIO



REF. 16030



## DATEJUST

-  Acero
-  36 mm
-  Automático

PRECIO   
\$8,650



CDE



CAJA





PAPELES



REF. 116200

AIR KING	DAYTONA	DATEJUST	DAY-DATE	EXPLORER	GMT-MASTER	MILGAUSS
OYSTER PERPETUAL	SEA-DWELLER	SKY-DWELLER	SUBMARINER	YACHT-MASTER	CELLINI	

## DATEJUST

-  Acero
-  41 mm
-  Automático

PRECIO   
\$9,500





OBARRIO



REF. 116300

## DATEJUST

-  Acero / Oro
-  41 mm
-  Automático

PRECIO   
\$10,800





OBARRIO



REF. 116334

## DATEJUST

-  Acero / Oro
-  41 mm
-  Automático

PRECIO   
\$10,500





OBARRIO



REF. 116334

## DATEJUST

-  Acero / Oro
-  41 mm
-  Automático

PRECIO   
\$11,000





OBARRIO



REF. 116334

## DATEJUST

-  Acero
-  41 mm
-  Automático

PRECIO   
\$11,500





OBARRIO



REF. 116300

## DATEJUST

-  Oro
-  36 mm
-  Automático

PRECIO   
\$15,500



OBARRIO





REF. VINTAGE

AIR KING	DAYTONA	DATEJUST	DAY-DATE	EXPLORER	GMT-MASTER	MILGAUSS
OYSTER PERPETUAL	SEA-DWELLER	SKY-DWELLER	SUBMARINER	YACHT-MASTER	CELLINI	

## DATEJUST



REF. 16220

-  Acero
-  36 mm
-  Automático

PRECIO   
\$6,200





OBARRIO

## DATEJUST PEARL MASTER

"DIAL MADRE PERLA"



REF. 80299

-  Oro/Diamantes
-  29 mm
-  Automático

PRECIO   
\$20,000



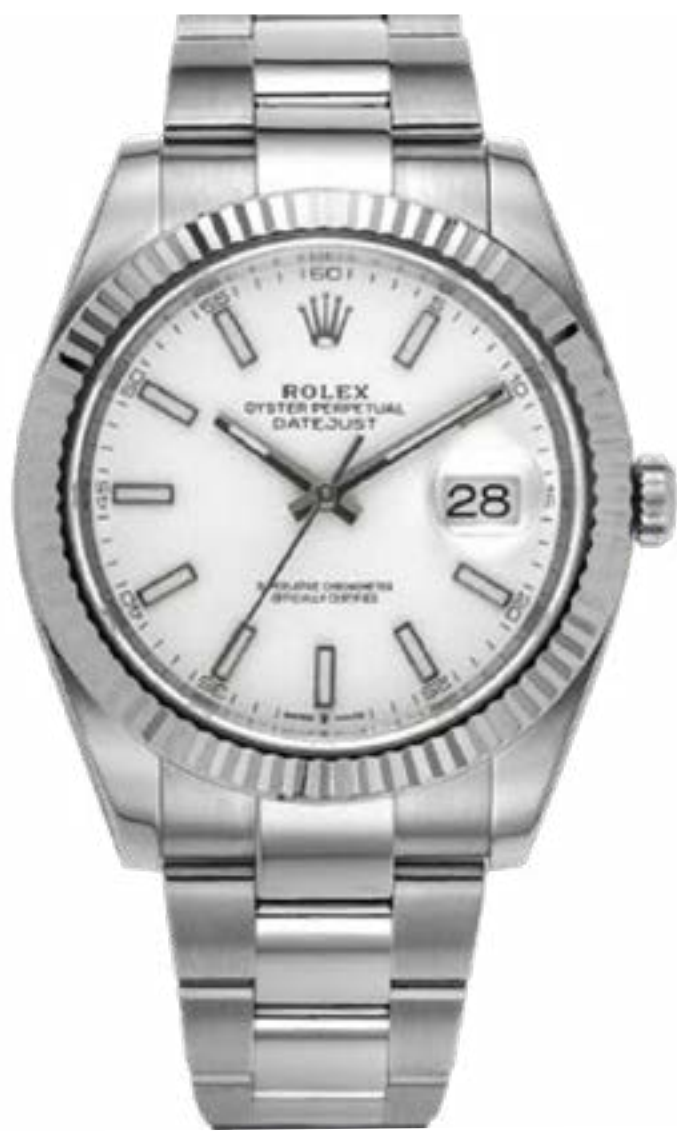

OBARRIO

## DATEJUST



REF. 126334

-  Acero / Oro
-  41 mm
-  Automático

PRECIO   
\$12,000





OBARRIO

## DATEJUST



REF. 16030

-  Acero
-  36 mm
-  Automático

PRECIO   
\$6,500





OBARRIO

## DATEJUST



REF. 116334

-  Acero / Oro
-  36 mm
-  Automático

PRECIO   
\$11,000





OBARRIO

## DATEJUST



REF. 116234

-  Acero
-  36 mm
-  Automático



PRECIO   
\$5,800



OBARRIO

AIR KING	DAYTONA	DATEJUST	DAY-DATE	EXPLORER	GMT-MASTER	MILGAUSS
OYSTER PERPETUAL	SEA-DWELLER	SKY-DWELLER	SUBMARINER	YACHT-MASTER	CELLINI	

## DATEJUST

-  Oro Amarillo
-  36 mm
-  Automático

PRECIO   
\$15,500



REF. 6605

## DATEJUST

"DIAL MADRE PERLA"



-  Oro / Diamantes
-  29 mm
-  Automático

PRECIO   
\$30,000



REF. 80318

## DATEJUST

-  Oro
-  31 mm
-  Automático

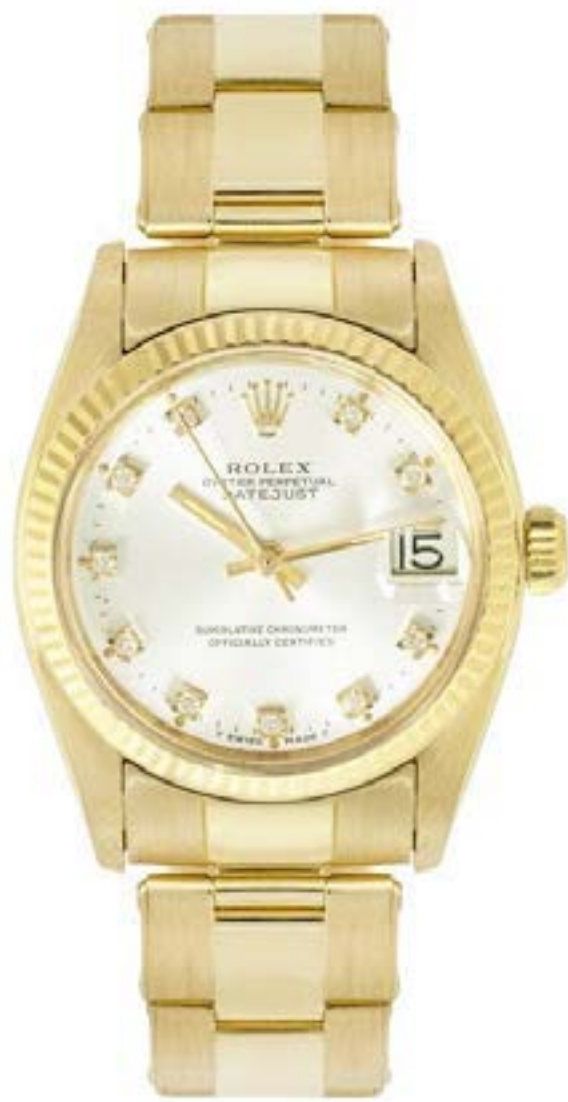

PRECIO   
\$14,000



REF. 6827

## DATEJUST

"PULSO NO ORIGINAL DE PLATA"



-  Oro
-  36 mm
-  Automático

PRECIO   
\$8,500



REF. 16018

## DATEJUST

-  Acero / Oro
-  26 mm
-  Automático

PRECIO   
\$4,500



REF. 6917

## DATEJUST

-  Acero / Oro / Dia.
-  41 mm
-  Automático

PRECIO   
\$14,000



REF. 116333

AIR KING	DAYTONA	DATEJUST	DAY-DATE	EXPLORER	GMT-MASTER	MILGAUSS
OYSTER PERPETUAL	SEA-DWELLER	SKY-DWELLER	SUBMARINER	YACHT-MASTER	CELLINI	



## DATEJUST

"PEARLMASTER"

- Acero
- 26 mm
- Automático

PRECIO \$9,500



CDE



PAPELES



REF. 179174

## DATEJUST

- Acero
- 31 mm
- Automático

PRECIO \$10,500



CDE



CAJA



PAPELES



REF. 278240

## DATEJUST

"BISEL & DIAL AFTERMARKET"

- Acero / Diamantes
- 41 mm
- Automático

PRECIO \$12,000



OBARRIO



REF. 126300

## DATEJUST

- Oro Rosa
- 26 mm
- Automático

PRECIO \$15,000



OBARRIO



REF. 179165

## DATEJUST

- Oro Rosa
- 26 mm
- Automático

PRECIO \$15,000



CDE



REF. 179165

AIR KING	DAYTONA	DATEJUST	DAY-DATE	EXPLORER	GMT-MASTER	MILGAUSS
OYSTER PERPETUAL	SEA-DWELLER	SKY-DWELLER	SUBMARINER	YACHT-MASTER	CELLINI	

## DATEJUST

- Acero y Oro
- 26 mm
- Automático

PRECIO

\$4,800



OBARRIO



REF. 69173

## DATEJUST

- Acero y Oro
- 41 mm
- Automático

PRECIO

\$16,500



OBARRIO



CAJA



PAPELES

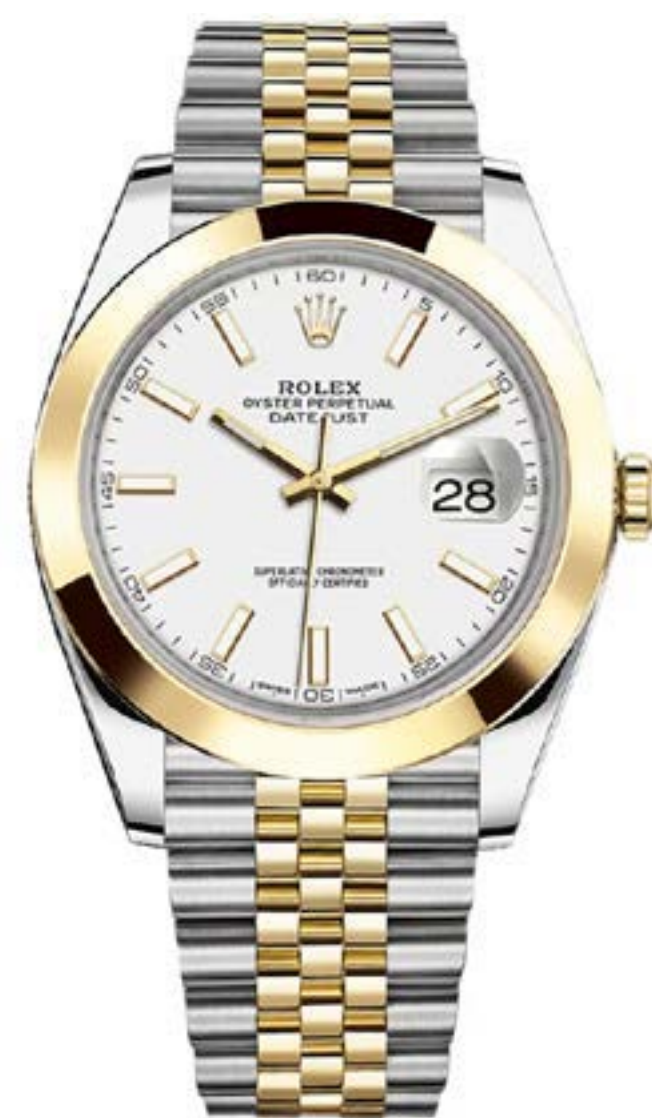

REF. 126303

## DATE

- Oro Amarillo
- 34 mm
- Automático

PRECIO

\$20,000



OBARRIO



REF. 1500

## DATEJUST

- Oro Rosa
- 41 mm
- Automático

PRECIO

\$14,000



CDE



CAJA



REF. 126301

## DATEJUST

- Acero / Oro
- 26 mm
- AUTOMÁTICO

PRECIO

\$9,500



OBARRIO



REF. 179161

## DATEJUST

- Acero / Oro Rosa
- 41 mm
- Automático

PRECIO

\$16,000



OBARRIO



CAJA



PAPELES



REF. 126301

AIR KING	DAYTONA	DATEJUST	DAY-DATE	EXPLORER	GMT-MASTER	MILGAUSS
OYSTER PERPETUAL	SEA-DWELLER	SKY-DWELLER	SUBMARINER	YACHT-MASTER	CELLINI	

## DATEJUST

 ACERO / DIAMANTES

 26 mm

 AUTOMÁTICO

PRECIO  
\$9,000



OBARRIO



CAJA



PAPELES



REF. 179174

## DATEJUST

 Acero / Oro

 26 mm

 Automático

PRECIO   
\$5,500



OBARRIO



PAPELES



REF. 69173

## DATEJUST

"BISEL DE ORO BLANCO"

 Acero / Oro

 41 mm

 Automático

PRECIO   
\$11,500



OBARRIO



REF. 116334

## DATEJUST

"BISEL DE ORO BLANCO"

 Acero / Oro

 41 mm

 Automático

PRECIO   
\$11,500



OBARRIO



REF. 116334

## DATEJUST

 Acero / Oro

 31 mm

 Automático

PRECIO   
\$17,000



OBARRIO



PAPELES



REF. 178313

## DATEJUST

 Oro

 31 mm

 Automático

PRECIO   
\$8,500





OBARRIO



REF. 6701

AIR KING	DAYTONA	DATEJUST	DAY-DATE	EXPLORER	GMT-MASTER	MILGAUSS
OYSTER PERPETUAL	SEA-DWELLER	SKY-DWELLER	SUBMARINER	YACHT-MASTER	CELLINI	

### LADY-DATEJUST

-  Acero
-  26 mm
-  Automático

PRECIO   
\$6,500



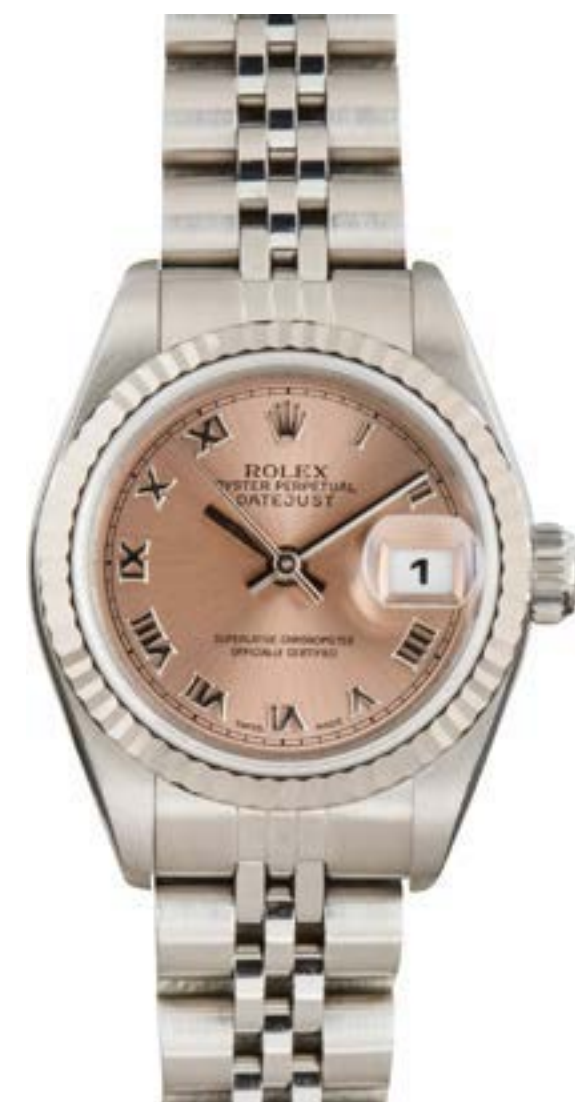

OBARRIO



REF. 69174

### DATEJUST

-  Acero / Oro
-  26 mm
-  Automático

PRECIO   
\$5,500





OBARRIO



REF. 69173

### DATEJUST

-  Acero / Oro
-  36 mm
-  Automático

PRECIO   
\$6,500





OBARRIO



REF. 16233

### DATEJUST

-  Acero
-  36 mm
-  Automático

PRECIO   
\$5,000



OBARRIO



CAJA



PAPELES



REF. 1603

### DATEJUST

-  ACERO / ORO
-  41 mm
-  AUTOMÁTICO

PRECIO  
\$17,000



OBARRIO



CAJA



REF. 126333

AIR KING	DAYTONA	DATEJUST	DAY-DATE	EXPLORER	GMT-MASTER	MILGAUSS
OYSTER PERPETUAL	SEA-DWELLER	SKY-DWELLER	SUBMARINER	YACHT-MASTER	CELLINI	



CAJA



# DAY-DATE



OBARRIO

-  Oro
-  41 mm
-  Automático

PRECIO   
\$39,800



REF. 218239

AIR KING	DAYTONA	DATEJUST	DAY-DATE	EXPLORER	GMT-MASTER	MILGAUSS
OYSTER PERPETUAL	SEA-DWELLER	SKY-DWELLER	SUBMARINER	YACHT-MASTER	CELLINI	

## DAY-DATE



REF. 18038

Oro Amarillo

36 mm

Automático

PRECIO \$23,000



CDE

## DAY-DATE

"CONFETI DIAL"



REF. 1803

Oro Amarillo

36 mm

Automático

PRECIO \$24,000



OBARRIO

## DAY-DATE

DIAL LAPISLAZULI Y DIAMANTES AFTERMARKET



REF. 18238

Oro Amarillo

36 mm

Automático

PRECIO \$25,000



OBARRIO

## DAY-DATE



REF. 18038

Oro Amarillo

36 mm

Automático

PRECIO \$20,000



OBARRIO

## DAY-DATE



REF. 18238

Oro Amarillo

36 mm

Automático

PRECIO \$23,000



CDE

## DAY-DATE



REF. 18238

Oro Amarillo

36 mm

Automático

PRECIO \$20,500



OBARRIO





CAJA

AIR KING	DAYTONA	DATEJUST	DAY-DATE	EXPLORER	GMT-MASTER	MILGAUSS
OYSTER PERPETUAL	SEA-DWELLER	SKY-DWELLER	SUBMARINER	YACHT-MASTER	CELLINI	

### DAY-DATE



-  Oro Amarillo
-  36 mm
-  Automático

PRECIO   
\$16,800





OBARRIO

REF. 1803

### DAY-DATE

"BISEL CON DIAMANTES"



-  Oro Amarillo
-  36 mm
-  Automático

PRECIO   
\$22,000



CDE

REF. 18048

### DAY-DATE



-  Oro / Diamantes
-  36 mm
-  Automático

PRECIO   
\$19,400



OBARRIO



CAJA

REF. 18038

### DAY-DATE

"DIAL DE DIAMANTES"



-  Oro / Diamantes
-  36 mm
-  Automático

PRECIO   
\$21,050





OBARRIO

REF. 18238

### DAY-DATE



-  Oro blanco
-  36 mm
-  Automático

PRECIO   
\$22,000





OBARRIO

REF. 18239

### DAY-DATE



-  Oro
-  36 mm
-  Automático

PRECIO   
\$17,800





OBARRIO

REF. 1803

AIR KING	DAYTONA	DATEJUST	DAY-DATE	EXPLORER	GMT-MASTER	MILGAUSS
OYSTER PERPETUAL	SEA-DWELLER	SKY-DWELLER	SUBMARINER	YACHT-MASTER	CELLINI	

## DAY-DATE

-  Oro
-  36 mm
-  Automático

PRECIO   
\$9,000





OBARRIO



REF. 1803

## DAY-DATE

"BISEL CON DIAMANTES"

-  Oro
-  36 mm
-  Automático

PRECIO   
\$15,000



OBARRIO



REF. 1803

## DAY-DATE

-  Oro
-  36 mm
-  Automático

PRECIO   
\$16,600



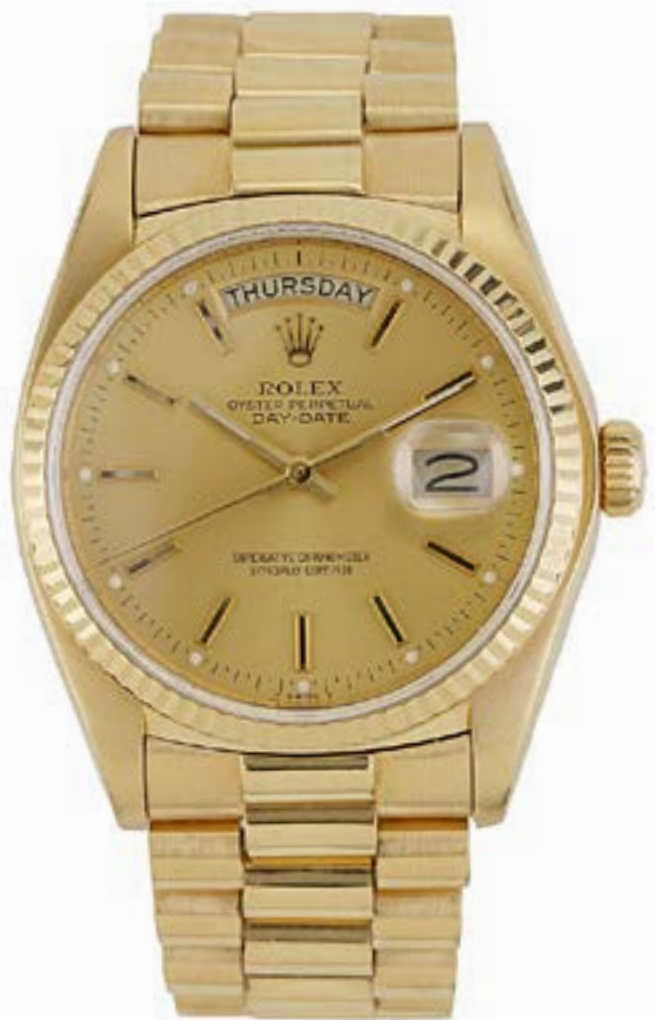

OBARRIO



REF. 1803

## DAY-DATE

-  Oro blanco
-  36 mm
-  Automático

PRECIO   
\$25,500



OBARRIO



CAJA





PAPELES



REF. 118209

## DAY-DATE

-  Oro
-  36 mm
-  Automático

PRECIO   
\$46,000



OBARRIO



CAJA



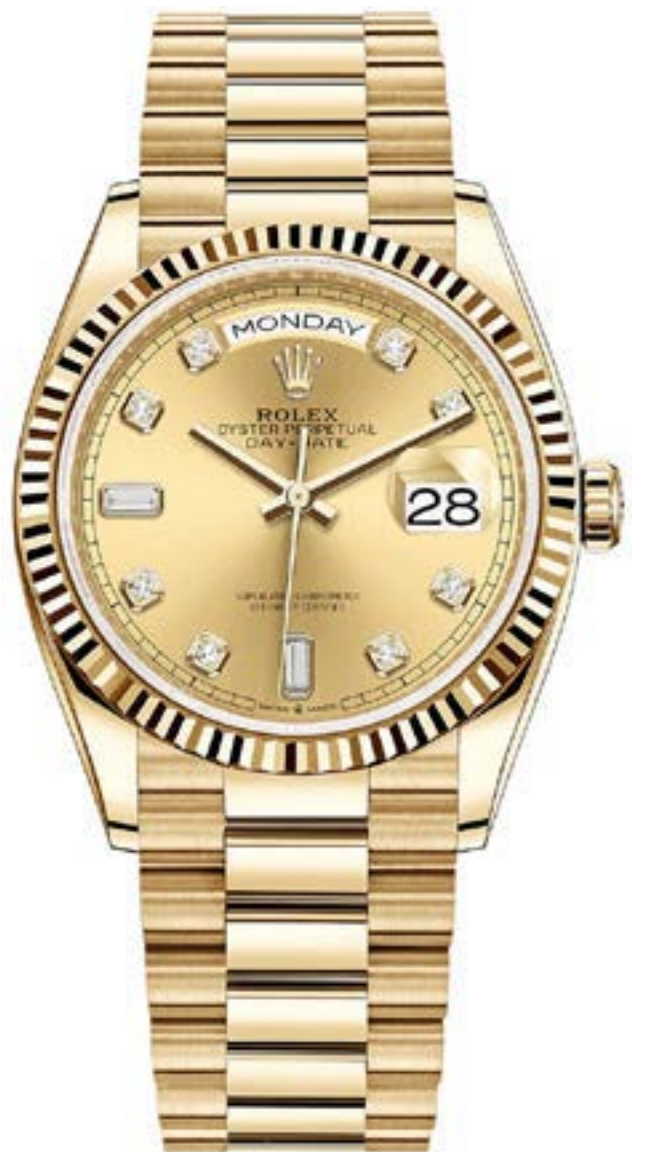

PAPELES



REF. 128238

## DAY-DATE

"COSTUM BEZEL & DIAL"

-  Oro
-  36 mm
-  Automático

PRECIO   
\$15,000



OBARRIO



REF. 1803

AIR KING	DAYTONA	DATEJUST	DAY-DATE	EXPLORER	GMT-MASTER	MILGAUSS
OYSTER PERPETUAL	SEA-DWELLER	SKY-DWELLER	SUBMARINER	YACHT-MASTER	CELLINI	

## DAY-DATE

 Oro Amarillo

 40 mm

 Automático

PRECIO 

\$48,000



OBARRIO



CAJA



PAPELES

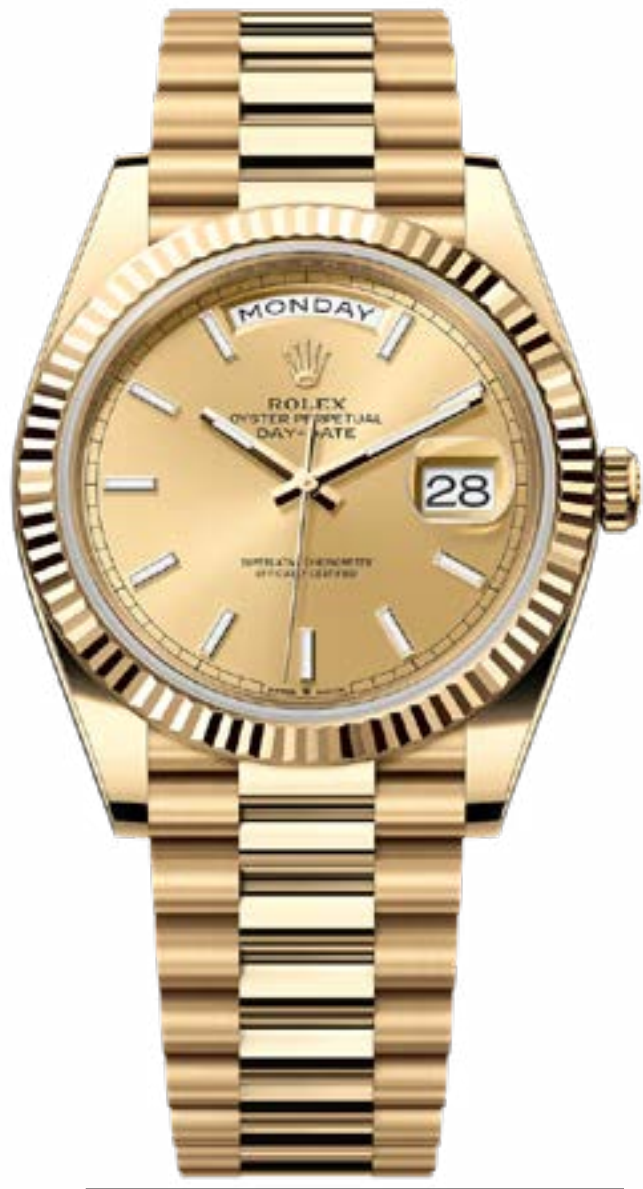

REF. 228238

## DAY-DATE

 Oro Rosa

 40 mm

 Automático

PRECIO 

\$48,000



OBARRIO



REF. 228235





ROLEX  
EXPLORER



El Explorer es un modelo emblemático de Rolex, inspirado en el espíritu de la exploración y la aventura. Presentado en 1953 tras la histórica ascensión al Monte Everest, fue diseñado para ofrecer máxima legibilidad, resistencia y precisión en condiciones extremas.

AIR KING	DAYTONA	DATEJUST	DAY-DATE	EXPLORER	GMT-MASTER	MILGAUSS
OYSTER PERPETUAL	SEA-DWELLER	SKY-DWELLER	SUBMARINER	YACHT-MASTER	CELLINI	

### EXPLORER II

-  Acero
-  40 mm
-  Automático

PRECIO   
\$8,000





OBARRIO



REF. 16570

### EXPLORER II

-  Acero
-  40 mm
-  Automático

PRECIO   
\$8,000





OBARRIO



REF. 16570



### EXPLORER II

-  Acero
-  40 mm
-  Automático

PRECIO   
\$8,000



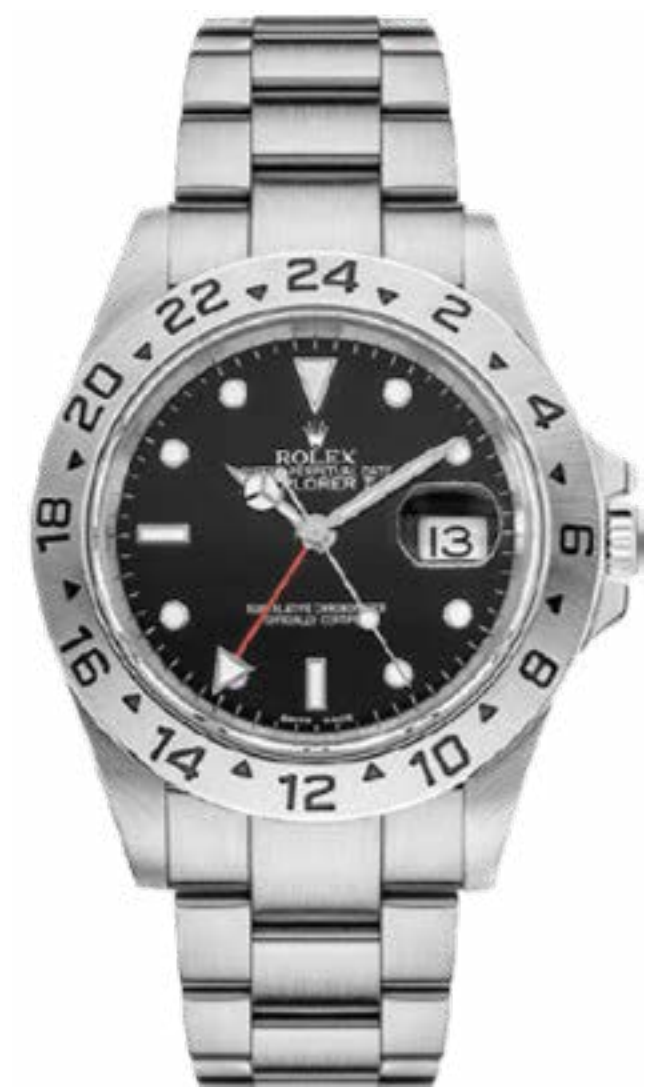

OBARRIO



REF. 16570



### EXPLORER II

-  Acero
-  40 mm
-  Automático

PRECIO   
\$9,500





CDE



REF. 16570

### EXPLORER II

-  Acero
-  40 mm
-  Automático

PRECIO   
\$8,000



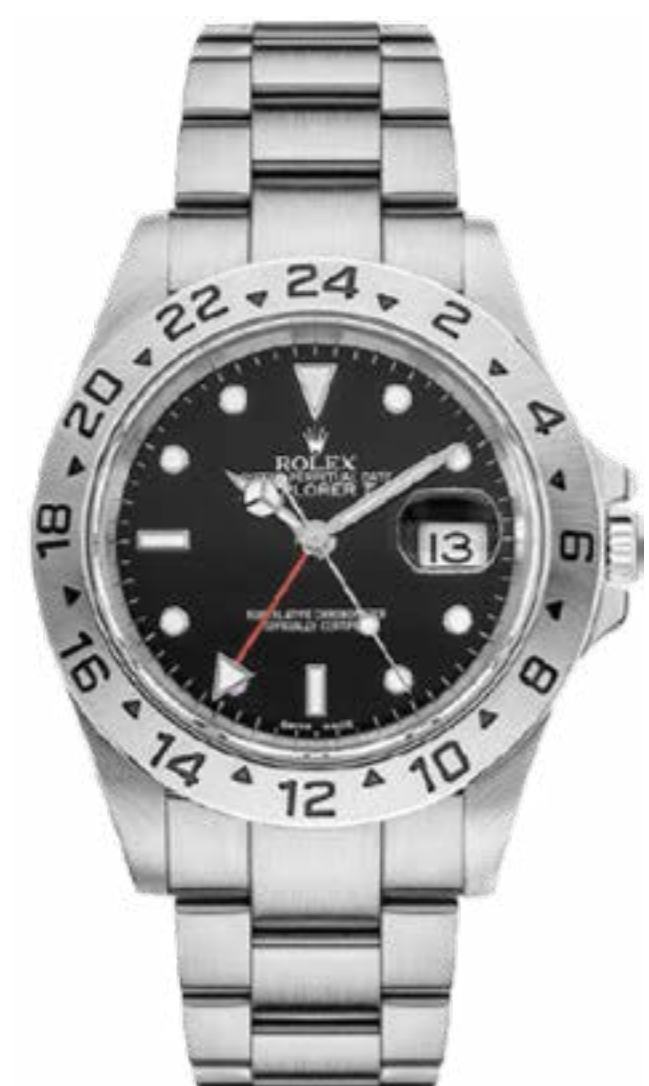

OBARRIO



REF. 16570

AIR KING	DAYTONA	DATEJUST	DAY-DATE	EXPLORER	GMT-MASTER	MILGAUSS
OYSTER PERPETUAL	SEA-DWELLER	SKY-DWELLER	SUBMARINER	YACHT-MASTER	CELLINI	

## EXPLORER II

-  Acero
-  42 mm
-  Automático



PRECIO   
\$11,800

-  OBARRIO
-  PAPELESCAJA
- 



REF. 216570

## EXPLORER II

-  Acero
-  42 mm
-  Automático

PRECIO   
\$11,800

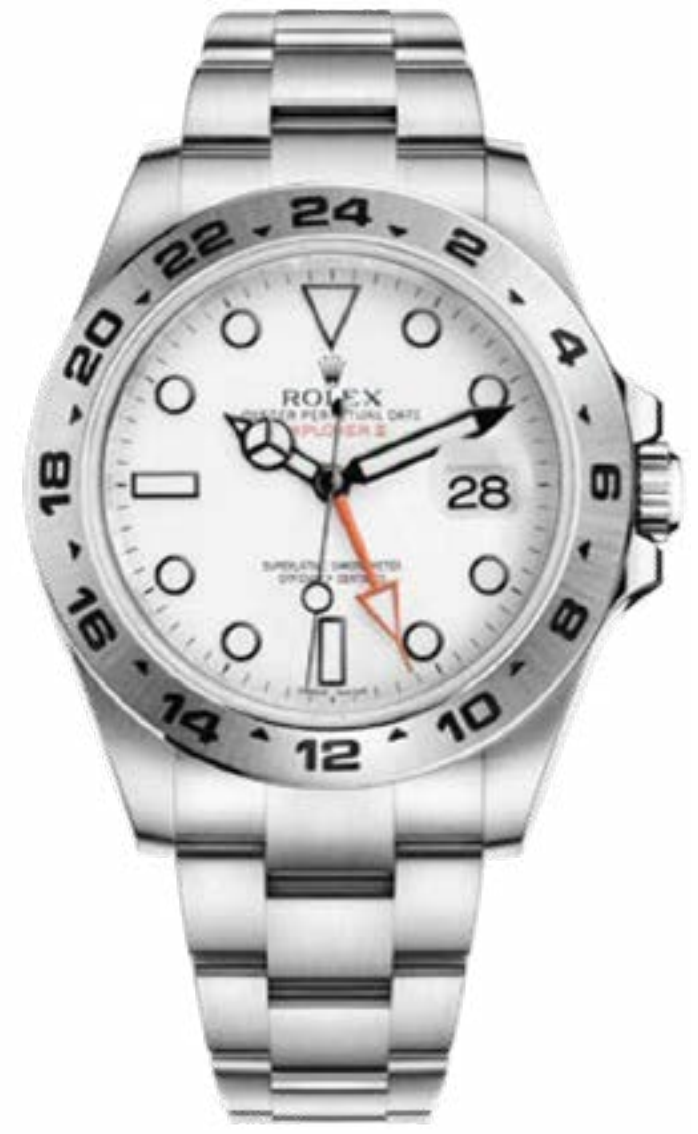

-  OBARRIO
-  PAPELESCAJA
- 





REF. 216570



## EXPLORER II

-  Acero
-  42 mm
-  Automático



PRECIO   
\$10,500

-  OBARRIO
-  PAPELESCAJA
- 



REF. 216570

## EXPLORER II

-  Acero
-  42 mm
-  Automático

PRECIO   
\$11,000

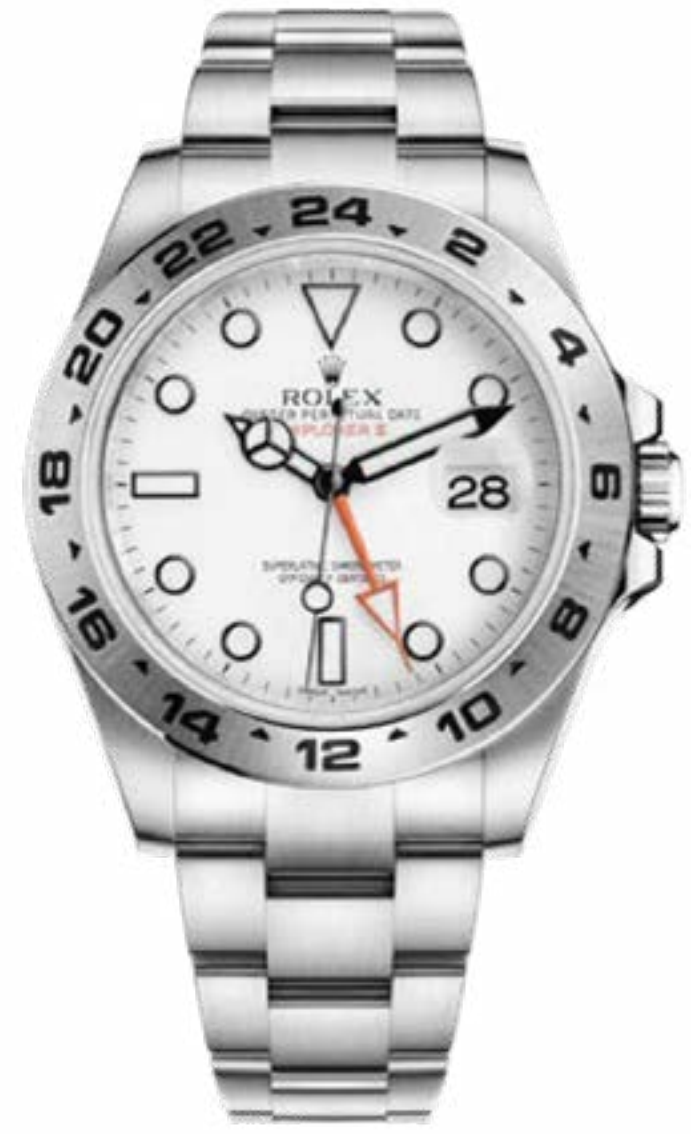

-  OBARRIO



REF. 216570



## EXPLORER II

-  Acero
-  42 mm
-  Automático

PRECIO   
\$11,000

-  OBARRIO



REF. 216570

AIR KING	DAYTONA	DATEJUST	DAY-DATE	EXPLORER	GMT-MASTER	MILGAUSS
OYSTER PERPETUAL	SEA-DWELLER	SKY-DWELLER	SUBMARINER	YACHT-MASTER	CELLINI	

**EXPLORER II**



- Acero
- 40 mm
- Automático

PRECIO \$8,500



OBARRIO

REF. 16570

**EXPLORER II**



- Acero
- 40 mm
- Automático

PRECIO \$8,500



OBARRIO

REF. 16570

**EXPLORER II**



- Acero
- 40 mm
- Automático

PRECIO \$14,000



OBARRIO

REF. 16570

**EXPLORER II**



- Acero
- 40 mm
- Automático

PRECIO \$10,000



OBARRIO

REF. 16570



AIR KING	DAYTONA	DATEJUST	DAY-DATE	EXPLORER	GMT-MASTER	MILGAUSS
OYSTER PERPETUAL	SEA-DWELLER	SKY-DWELLER	SUBMARINER	YACHT-MASTER	CELLINI	



ROOT BEER

GMT-MASTER



-  Oro
-  40 mm
-  Automático

**PRECIO**   
\$50,000

REF. 1675

  
OBARRIO





REF. 126710BLN



-  Acero
-  40 mm
-  Automático



PRECIO   
\$19,000

# GMT-MASTER II BATGIRL



# GMT-MASTER II



Acero



40 mm



Automático



PAPELESCAJA

PRECIO



\$19,000



OBARRIO

REF. 126710BLNR



# BATMAN

AARON  JOYEROS

AIR KING	DAYTONA	DATEJUST	DAY-DATE	EXPLORER	GMT-MASTER	MILGAUSS
OYSTER PERPETUAL	SEA-DWELLER	SKY-DWELLER	SUBMARINER	YACHT-MASTER	CELLINI	

**GMT-MASTER II** — **BATMAN**

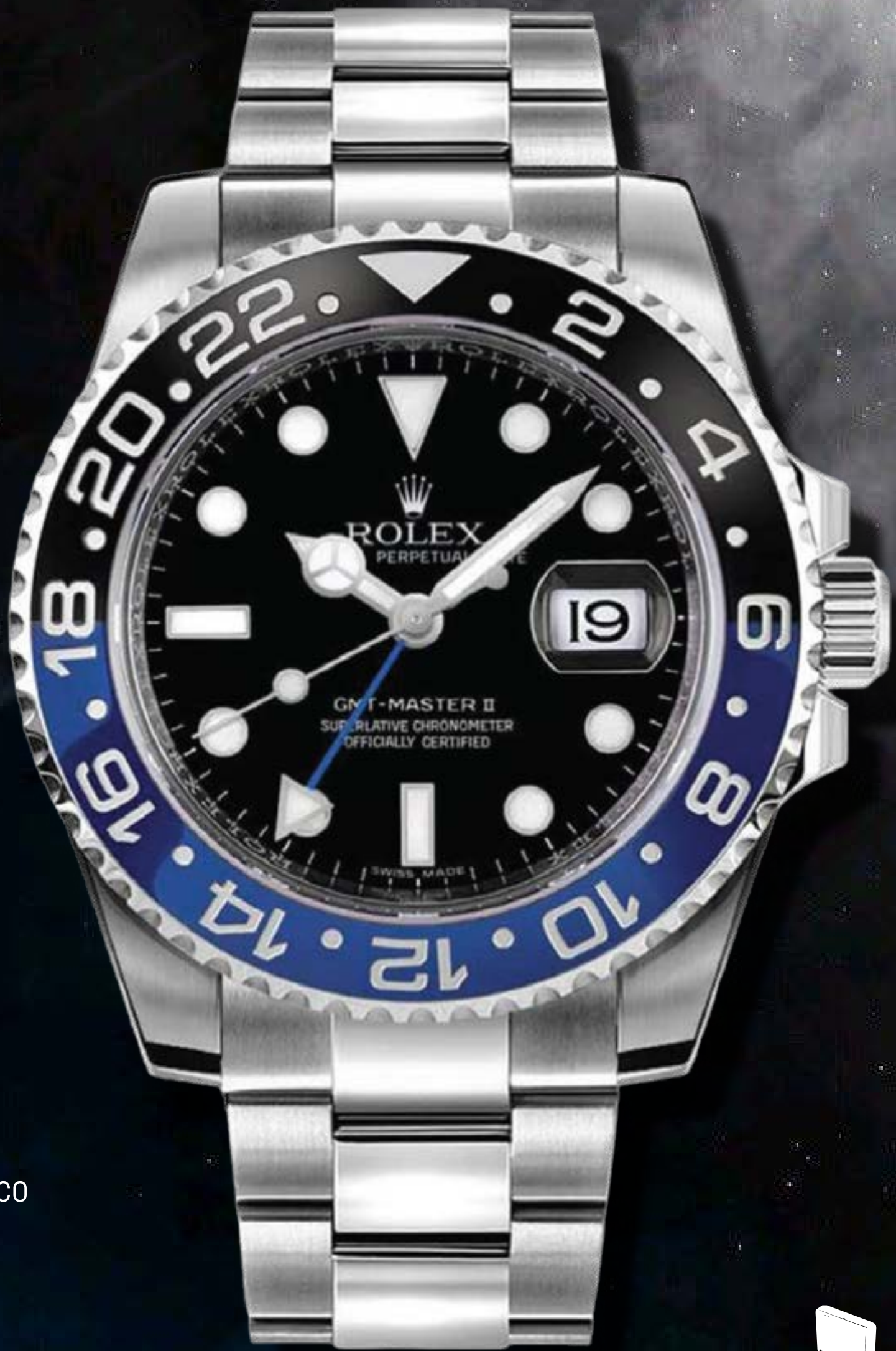

-  Acero
-  40 mm
-  Automático

**PRECIO**   
 \$16,800



REF. 116710BLNR







# GMT-MASTER II

## PEPSI



-  Acero
-  40 mm
-  Automático



OBARRIO

PRECIO  
\$13,000





16700

AIR KING	DAYTONA	DATEJUST	DAY-DATE	EXPLORER	GMT-MASTER	MILGAUSS
OYSTER PERPETUAL	SEA-DWELLER	SKY-DWELLER	SUBMARINER	YACHT-MASTER	CELLINI	

## GMT-MASTER II

### ROOT BEER



-  Acero / Oro
-  40 mm
-  Automático

PRECIO   
\$14,800

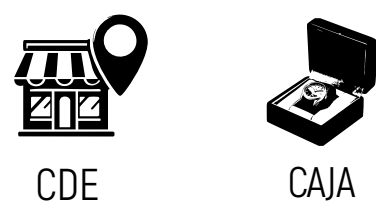





REF. 16753

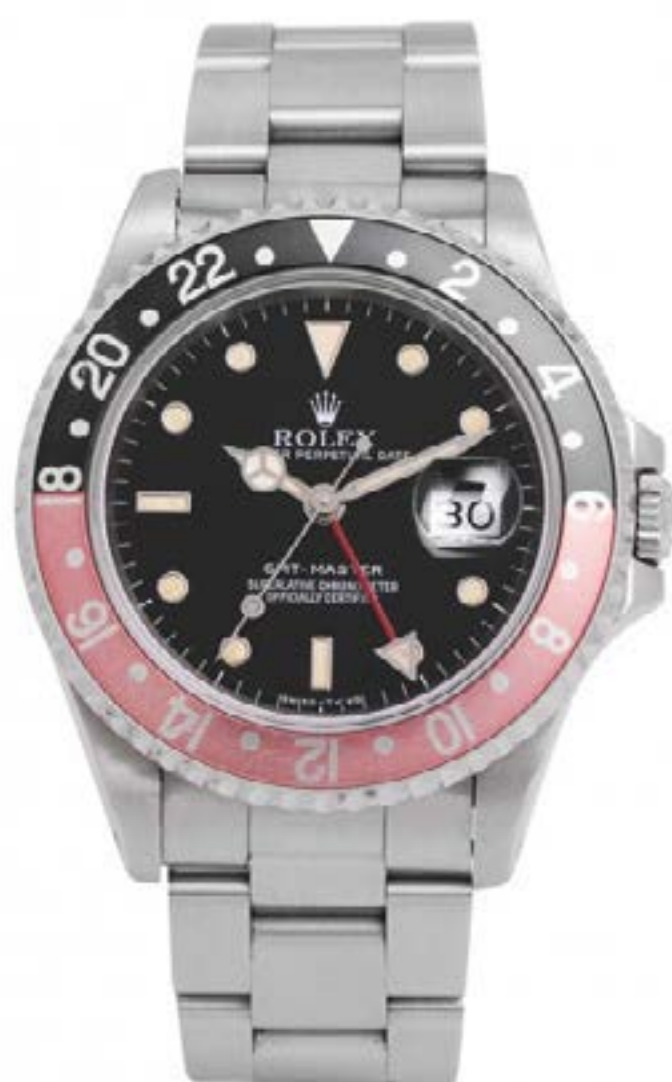

## GMT-MASTER II

"SPYDER DIAL" 



-  Acero
-  40 mm
-  Automático

PRECIO   
\$10,800



REF. 16700



## GMT-MASTER II

### BATGIRL



-  ACERO
-  40 mm
-  AUTOMÁTICO

PRECIO  
\$20,500

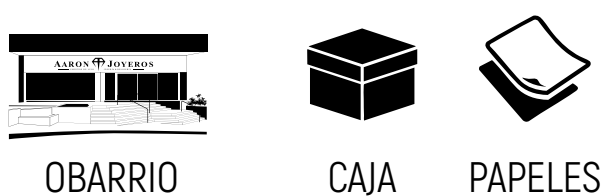

REF. 126710BLN

AIR KING	DAYTONA	DATEJUST	DAY-DATE	EXPLORER	GMT-MASTER	MILGAUSS
OYSTER PERPETUAL	SEA-DWELLER	SKY-DWELLER	SUBMARINER	YACHT-MASTER	CELLINI	

**GMT-MASTER**

"NIPLE DIAL"

- Acero / Oro
- 40 mm
- Automático

PRECIO   
\$10,000



CDE



REF. 16753

**GMT-MASTER**

- Acero / Oro
- 40 mm
- Automático

PRECIO   
\$11,500



OBARRIO

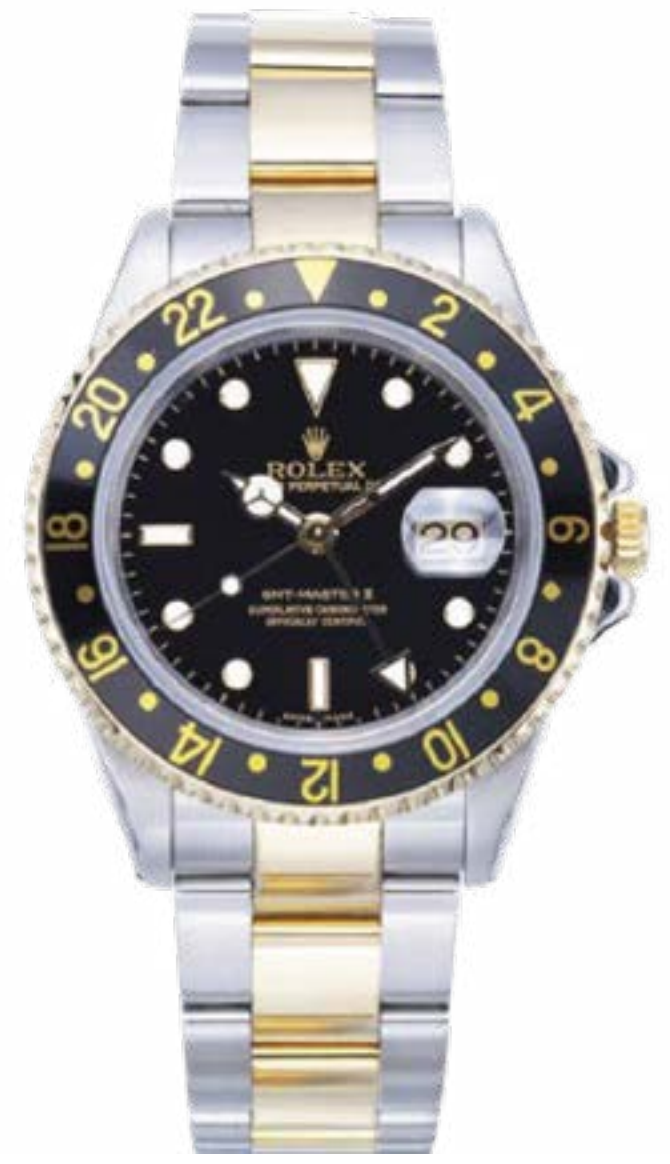

REF. 16713

**GMT-MASTER**

- Acero / Oro
- 40 mm
- Automático

PRECIO   
\$10,500



OBARRIO



REF. 1675

**GMT-MASTER**

"NIPLE DIAL"

- Acero / Oro
- 40 mm
- Automático

PRECIO   
\$9,000



OBARRIO



REF. 1675

**GMT-MASTER**

- Acero / Oro
- 40 mm
- Automático

PRECIO   
\$10,800



OBARRIO





REF. 16753



AIR KING	DAYTONA	DATEJUST	DAY-DATE	EXPLORER	GMT-MASTER	MILGAUSS
OYSTER PERPETUAL	SEA-DWELLER	SKY-DWELLER	SUBMARINER	YACHT-MASTER	CELLINI	

## GMT-MASTER II

-  Acero
-  40 mm
-  Automático



PRECIO   
\$13,000



REF. 116710LN



## GMT-MASTER II

-  Acero
-  40 mm
-  Automático

PRECIO   
\$14,000



REF. 16750





# OYSTER PERPETUAL MILGAUSS



OBARRIO



-  Acero
-  40 mm
-  Automático

PRECIO   
\$9,800

REF. 116400



ROLEX

OYSTER PERPETUAL  
MILGAUSS



OBARRIO

REF 116400

REF

MILGAUSS

- Acero
- 40 mm
- Automático

PRECIO \$9,800



ROLEX



# OYSTER PERPETUAL



Acero



39 mm



Automático

PRECIO   
\$8,500



114300

REF





O BARRIO



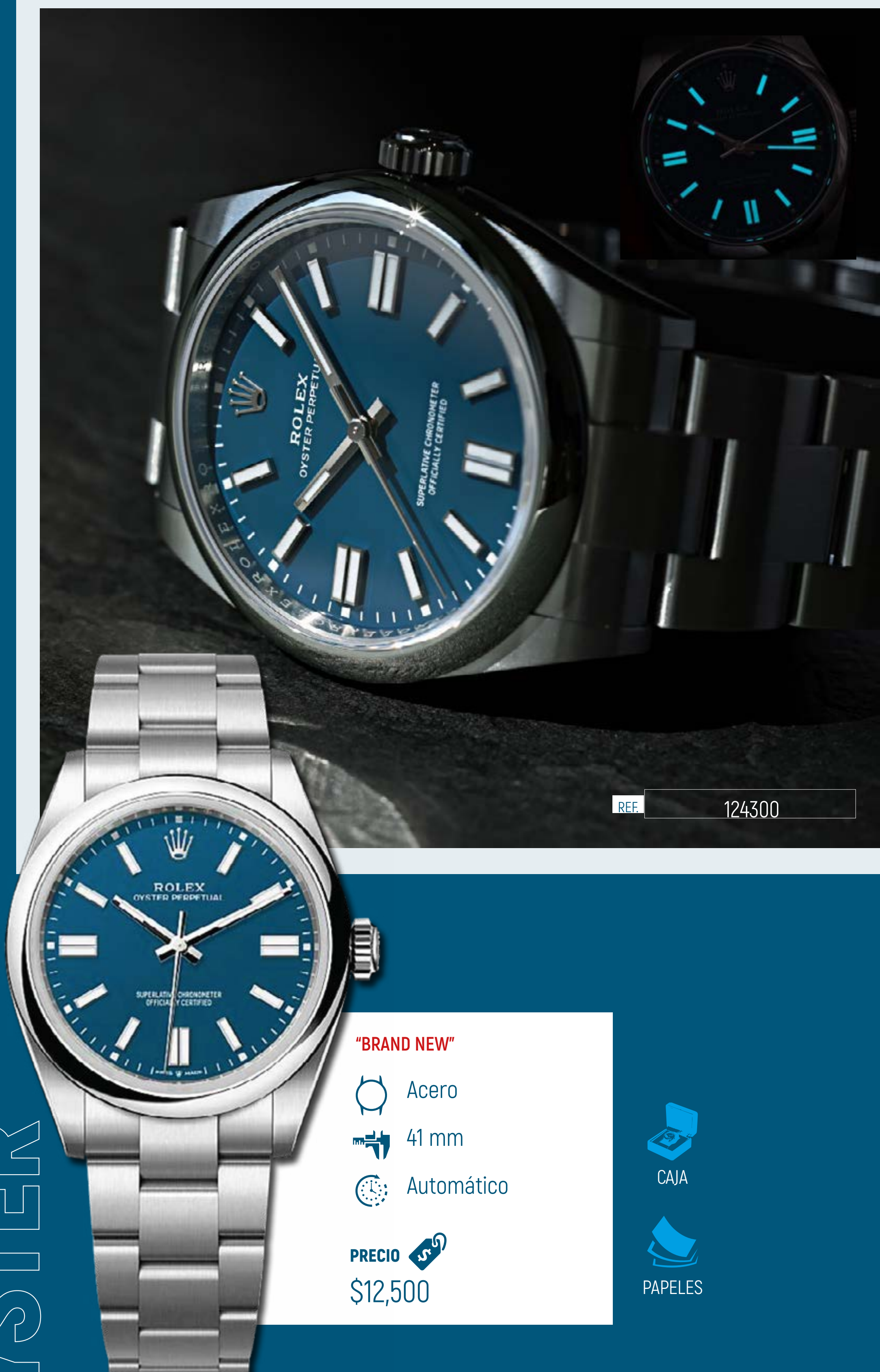

# PERPETUAL

# OYSTER



REF. 124300

**"BRAND NEW"**

-  Acero
-  41 mm
-  Automático

PRECIO   
\$12,500



CAJA





PAPELES

AIR KING	DAYTONA	DATEJUST	DAY-DATE	EXPLORER	GMT-MASTER	MILGAUSS
OYSTER PERPETUAL	SEA-DWELLER	SKY-DWELLER	SUBMARINER	YACHT-MASTER	CELLINI	

## OYSTER PERPETUAL

"TIFFANY DIAL"

-  Acero
-  31 mm
-  Automático



PRECIO   
\$12,500

-  OBARRIO
-  PAPELESCAJA
- 

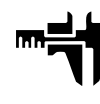

REF. 277200

## OYSTER PERPETUAL CORAL ROJO

-  Acero
-  31 mm
-  Automático

PRECIO   
\$11,000

-  OBARRIO
- 



REF. 277200

## OYSTER PERPETUAL

-  Oro Amarillo
-  31 mm
-  Cuerda Manual



PRECIO   
\$8,600

-  CDE



REF. 6619

## OYSTER PERPETUAL

-  Oro
-  34 mm
-  Automático



PRECIO   
\$11,500

-  OBARRIO



REF. 100S

## OYSTER PERPETUAL

-  Oro Amarillo
-  24 mm
-  Automático



PRECIO   
\$9,500

-  OBARRIO
-  CAJA



REF. 6617

## OYSTER PERPETUAL DATE

-  Acero / Oro
-  25 mm
-  Automático

PRECIO   
\$4,000

-  OBARRIO





REF. 6517

AIR KING	DAYTONA	DATEJUST	DAY-DATE	EXPLORER	GMT-MASTER	MILGAUSS
OYSTER PERPETUAL	SEA-DWELLER	SKY-DWELLER	SUBMARINER	YACHT-MASTER	CELLINI	



## OYSTER PERPETUAL

"DÓMINOS PIZZA"

"NUEVO A ESTRENAR"

-  Acero
-  36 mm
-  Automático



PRECIO   
\$9,000

-  OBARRIO
-  PAPELESCAJA
- 



REF. 116000

## OYSTER PERPETUAL

-  Acero
-  36 mm
-  Automático

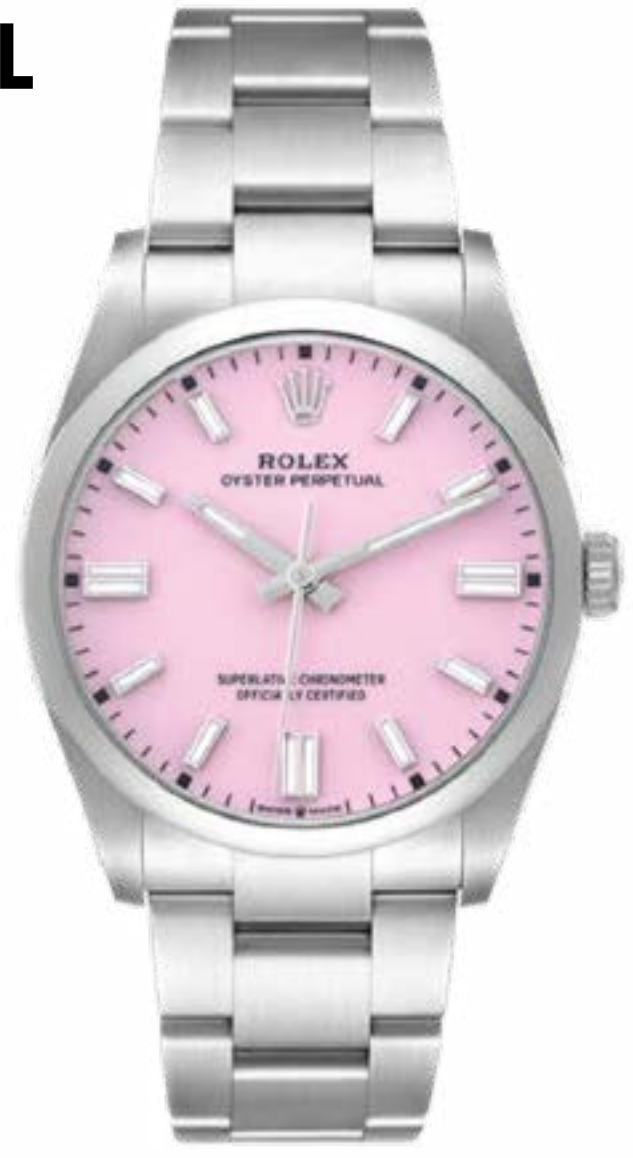

PRECIO   
\$13,000

-  OBARRIO
-  PAPELESCAJA
- 



REF. 126000

## OYSTER PERPETUAL

-  Acero
-  24 mm
-  Automático



PRECIO   
\$2,500

-  OBARRIO



REF. 6516

## OYSTER PERPETUAL

-  Oro
-  36 mm
-  Automático



PRECIO   
\$11,500

-  OBARRIO



REF. 1005

## OYSTER PERPETUAL

-  Acero / Oro
-  26 mm
-  Automático

PRECIO   
\$4,000

-  OBARRIO



REF. 6917

# SEA-DWELLER

## DEEPSEA

136660

 Acero

 44 mm

 Automático

PRECIO   
\$17,500





ROLEX

# SEA-DWELLER



Acero



40 mm



Automático

PRECIO



\$9,250



16600

REF

  
**ROLEX**

# SKY-DWELLER



 Oro Rosa

 42 mm

 Automático

PRECIO   
\$44,000

  
OBARRIO

  
PAPELES

REF 326235



AARON  JOYEROS

AIR KING	DAYTONA	DATEJUST	DAY-DATE	EXPLORER	GMT-MASTER	MILGAUSS
OYSTER PERPETUAL	SEA-DWELLER	SKY-DWELLER	SUBMARINER	YACHT-MASTER	CELLINI	



# SKY-DWELLER



-  Acero / Oro
-  42 mm
-  Automático

**PRECIO**   
\$22,500

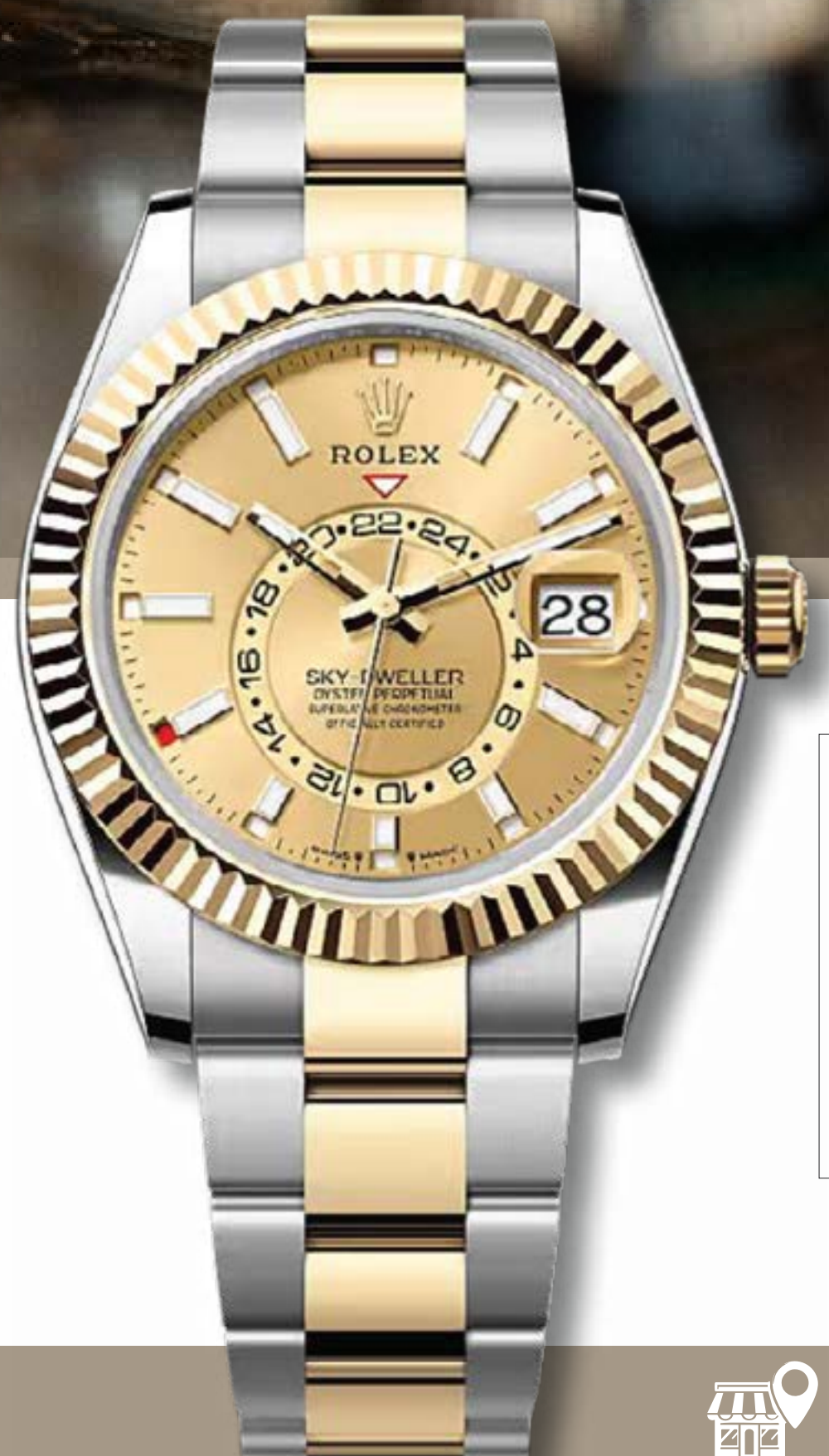

REF 326933



# SKY-DWELLER

El Rolex Sky-Dweller es uno de los modelos más sofisticados de Rolex, creado para viajeros frecuentes que requieren funcionalidad y elegancia en una sola pieza. Combina un calendario anual que distingue automáticamente los meses de 30 y 31 días con un segundo huso horario visible mediante un disco excéntrico en la esfera.

  
**ROLEX**



 Oro Rosa 18 k

 42 mm

 Automático

PRECIO   
\$45,000

  
CDE

  
CAJA

REF. 326935

AARON  JOYEROS

AIR KING	DAYTONA	DATEJUST	DAY-DATE	EXPLORER	GMT-MASTER	MILGAUSS
OYSTER PERPETUAL	SEA-DWELLER	SKY-DWELLER	SUBMARINER	YACHT-MASTER	CELLINI	

## SKY-DWELLER

 Acero / Oro

 42 mm

 Automático

PRECIO 

\$22,800



OBARRIO



PAPELESCAJA



REF. 336933



## SKY-DWELLER

 Oro Rosa

 42 mm

 Automático

PRECIO 

\$49,500



OBARRIO



PAPELESCAJA

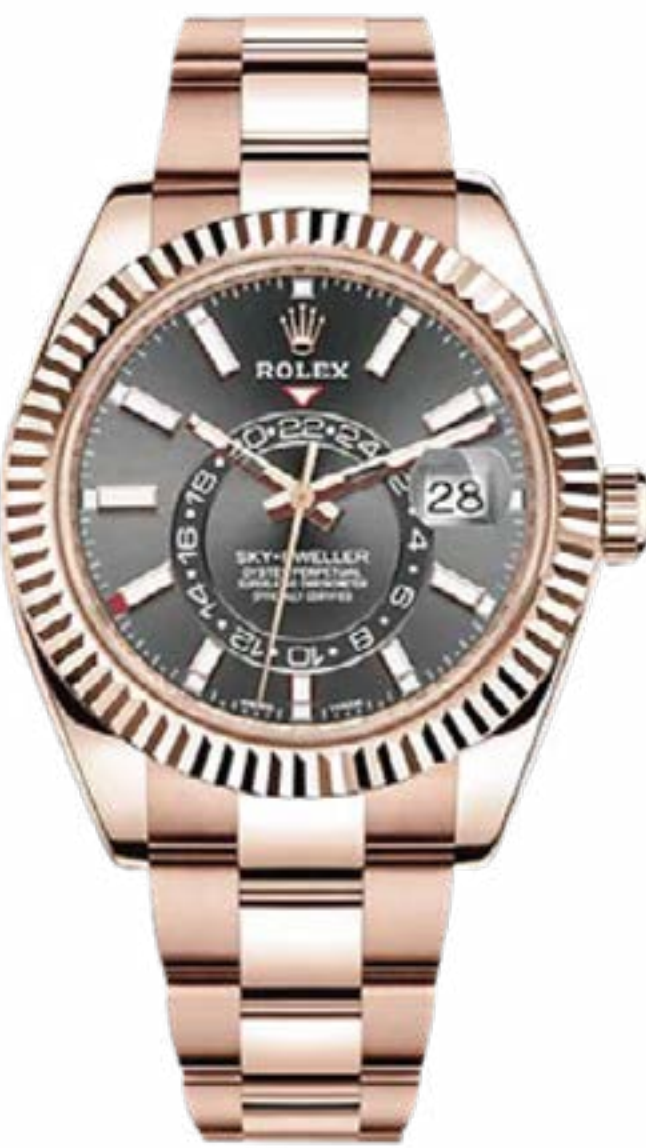

REF. 326935



## SKY-DWELLER

 Acero

 42 mm

 Automático

PRECIO 

\$24,500



OBARRIO



PAPELESCAJA



REF. 326934



**ROLEX**

# SUBMARINER

El Rolex Submariner, lanzado en 1953 por Rolex, es uno de los relojes de buceo más icónicos del mundo. Diseñado para ofrecer máxima resistencia y precisión bajo el agua, combina funcionalidad profesional con una estética elegante y atemporal, convirtiéndose en un símbolo de lujo deportivo y referencia en la alta relojería.



# SUBMARINER

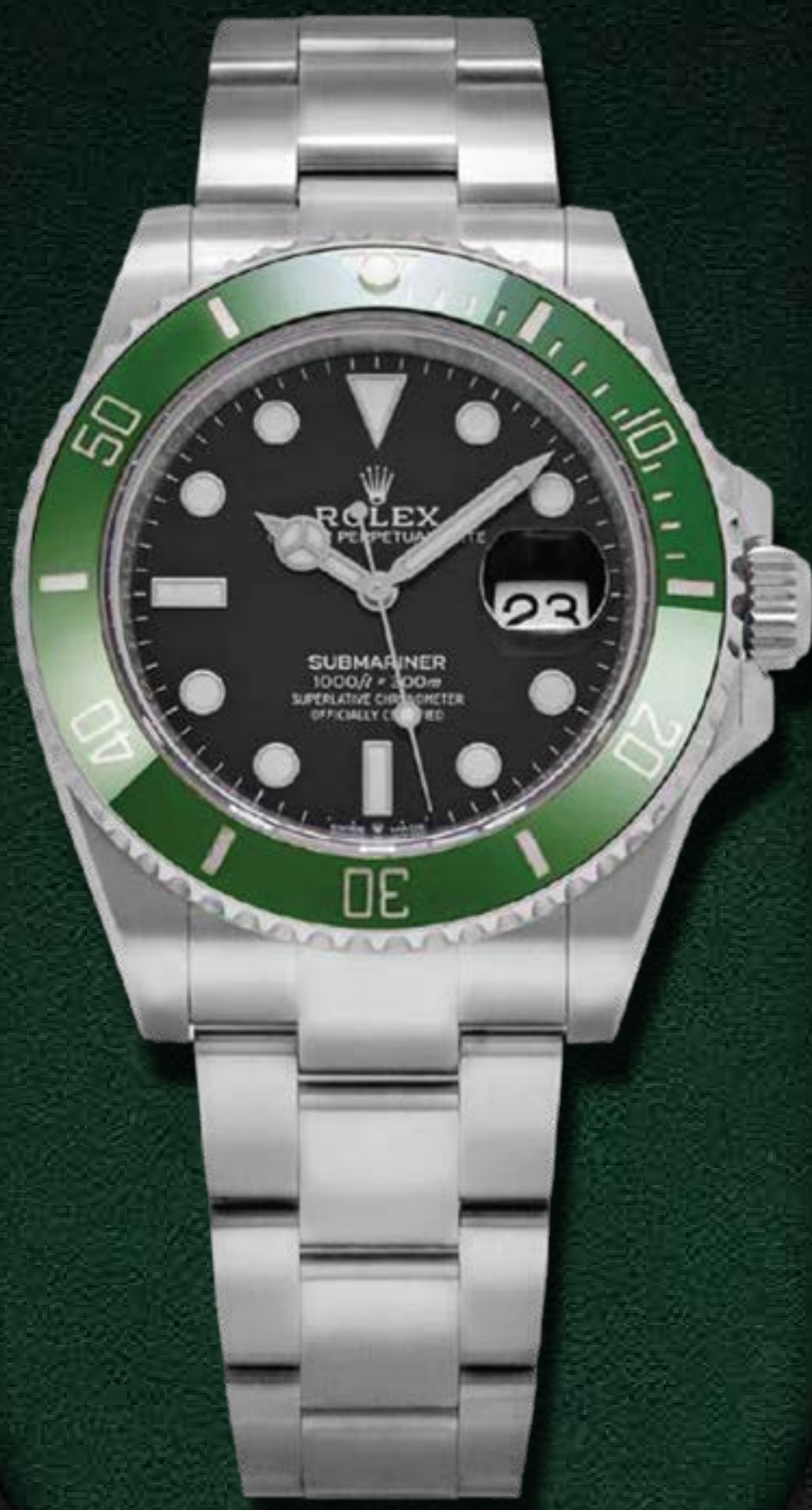

"NUEVO A ESTRENAR"

# STARBUCKS



Acero



40 mm



Automático

PRECIO



\$17,800



PAPELESCAJA

REF.

126610LV

AARON  JOYEROS

AIR KING	DAYTONA	DATEJUST	DAY-DATE	EXPLORER	GMT-MASTER	MILGAUSS
OYSTER PERPETUAL	SEA-DWELLER	SKY-DWELLER	SUBMARINER	YACHT-MASTER	CELLINI	

**SUBMARINER**

KERMIT

"50 ANIVERSARIO"



- Acero
- 40 mm
- Automático

PRECIO \$12,500



OBARRIO



REF. 16610LV

**SUBMARINER**

KERMIT

"50 ANIVERSARIO"

- Acero
- 40 mm
- Automático

PRECIO \$12,500



CDE



CAJA



REF. 16610LV

**SUBMARINER**

KERMIT

- Acero
- 40 mm
- Automático

PRECIO \$12,000



OBARRIO



REF. 16610LV

**SUBMARINER**

KERMIT

- Acero
- 40 mm
- Automático

PRECIO \$12,500



OBARRIO



CAJA



REF. 16610LV

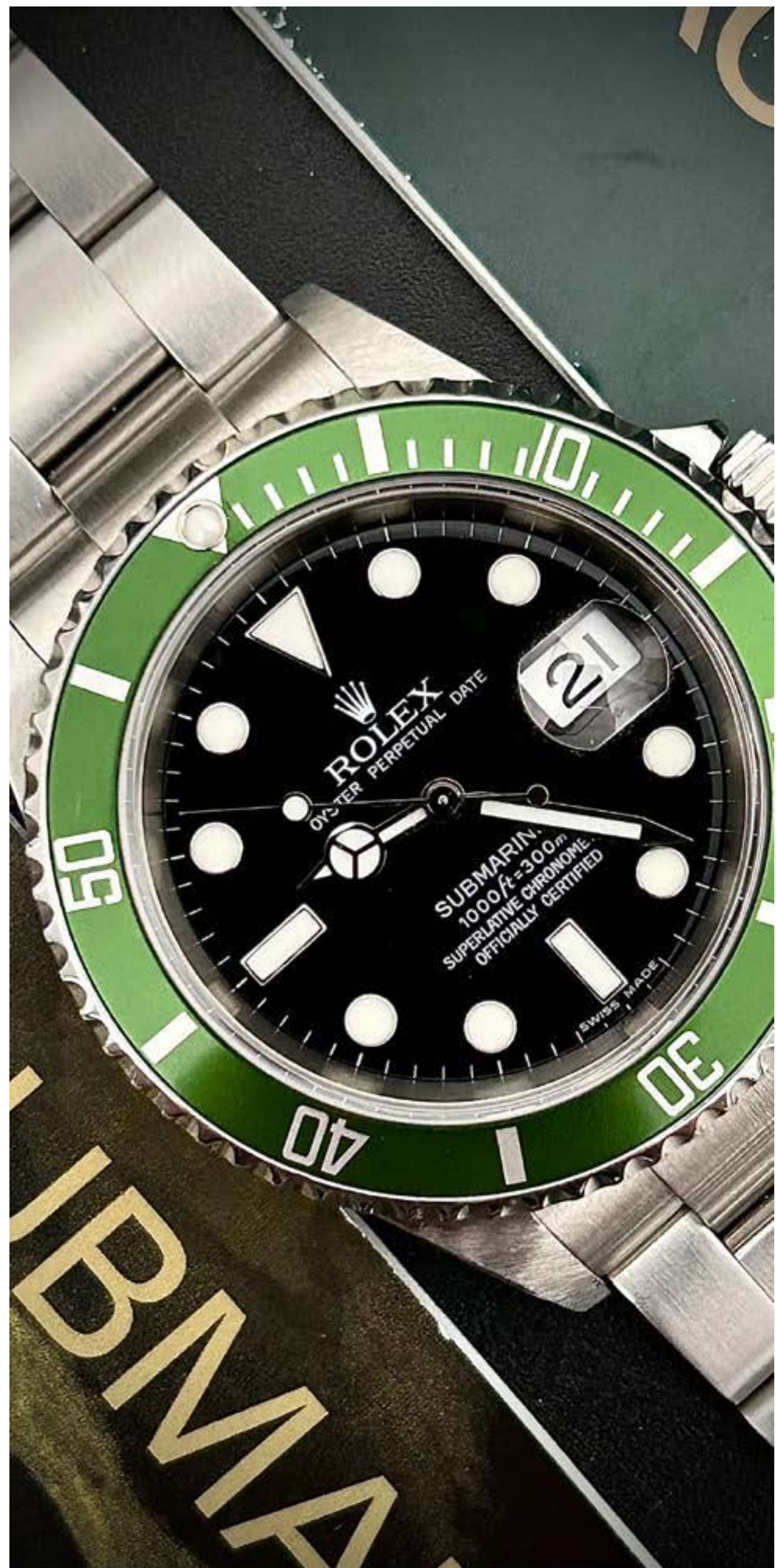



ROLEX



# SUBMARINER



Acero



40 mm



Automático

PRECIO



\$10,000

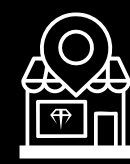

OBARRIO



16610

REF

AARON  JOYEROS

AIR KING	DAYTONA	DATEJUST	DAY-DATE	EXPLORER	GMT-MASTER	MILGAUSS
OYSTER PERPETUAL	SEA-DWELLER	SKY-DWELLER	SUBMARINER	YACHT-MASTER	CELLINI	

## SUBMARINER DATE

-  Acero
-  40 mm
-  Automático

PRECIO   
\$9,600





OBARRIO



REF. 16610

## SUBMARINER DATE

-  Acero
-  40 mm
-  Automático

PRECIO   
\$9,700



OBARRIO





CAJA



REF. 16610



## SUBMARINER DATE

-  Acero
-  40 mm
-  Automático

PRECIO   
\$10,000





OBARRIO



REF. 16610

## SUBMARINER DATE

-  Acero
-  40 mm
-  Automático

PRECIO   
\$10,000



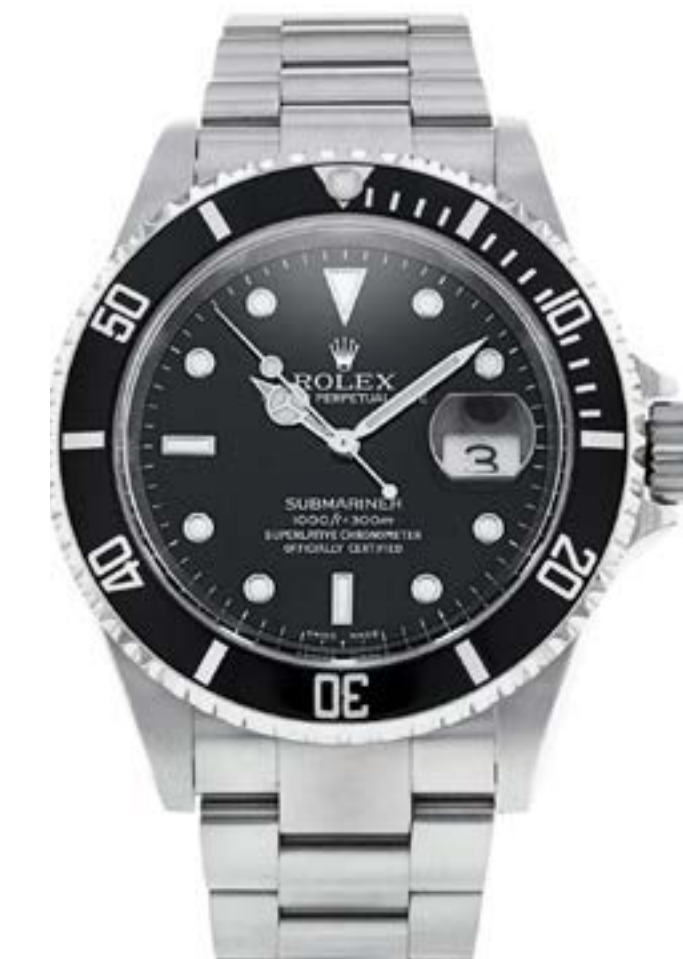

OBARRIO



REF. 16610



## SUBMARINER DATE

-  Acero
-  40 mm
-  Automático

PRECIO   
\$12,000



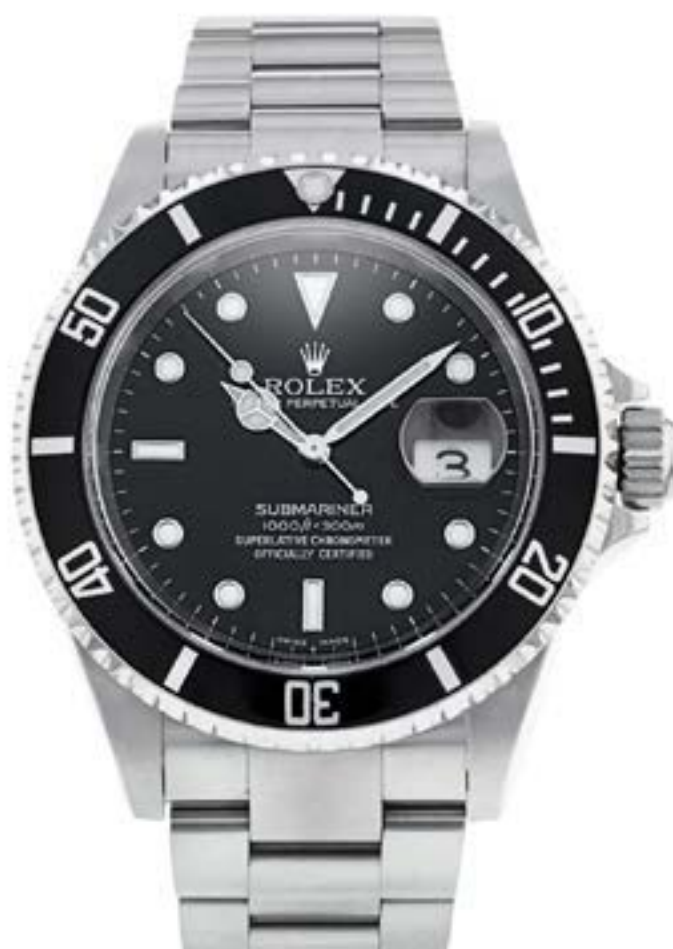

CDE





REF. 16610

AIR KING	DAYTONA	DATEJUST	DAY-DATE	EXPLORER	GMT-MASTER	MILGAUSS
OYSTER PERPETUAL	SEA-DWELLER	SKY-DWELLER	SUBMARINER	YACHT-MASTER	CELLINI	

## SUBMARINER DATE

-  Acero
-  40 mm
-  Automático



PRECIO   
\$10,500

-  OBARRIO
-  PAPELESCAJA



REF. 16610

## SUBMARINER NO DATE

-  Acero
-  40 mm
-  Automático



PRECIO   
\$13,000

-  OBARRIO



REF. 5512

## SUBMARINER DATE

-  Acero
-  40 mm
-  Automático



PRECIO   
\$12,800

-  OBARRIO



REF. 1680

## SUBMARINER NO DATE

-  Acero
-  40 mm
-  Automático



PRECIO   
\$16,000

-  OBARRIO



REF. 5513

## SUBMARINER DATE

-  Acero
-  40 mm
-  Automático



PRECIO   
\$16,500

-  OBARRIO



REF. 1680

## SUBMARINER NO DATE

-  Acero
-  40 mm
-  Automático

PRECIO   
\$8,500

-  OBARRIO



REF. 14060

AIR KING	DAYTONA	DATEJUST	DAY-DATE	EXPLORER	GMT-MASTER	MILGAUSS
OYSTER PERPETUAL	SEA-DWELLER	SKY-DWELLER	SUBMARINER	YACHT-MASTER	CELLINI	

**SUBMARINER**  
NO DATE

- Acero
- 40 mm
- Automático

PRECIO   
\$10,000



OBARRIO



REF. 14060M

**SUBMARINER**  
NO DATE

- Acero
- 40 mm
- Automático

PRECIO   
\$11,500



OBARRIO



REF. 114060

**SUBMARINER**  
DATE

- Acero
- 40 mm
- Automático

PRECIO   
\$13,800



OBARRIO



PAPELESCAJA



REF. 116610

**SUBMARINER**  
DATE

- Acero
- 40 mm
- Automático

PRECIO   
\$13,500



OBARRIO



PAPELESCAJA





REF. 116610



AIR KING	DAYTONA	DATEJUST	DAY-DATE	EXPLORER	GMT-MASTER	MILGAUSS
OYSTER PERPETUAL	SEA-DWELLER	SKY-DWELLER	SUBMARINER	YACHT-MASTER	CELLINI	

## SUBMARINER DATE

-  Acero
-  40 mm
-  Automático



PRECIO   
\$13,800

-  OBARRIO
-  PAPELESCAJA

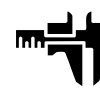

REF. 116610

## SUBMARINER NO DATE

-  Acero
-  40 mm
-  Automático



PRECIO   
\$10,000

-  CDE



REF. 5513

## SUBMARINER DATE

-  Acero
-  40 mm
-  Automático



PRECIO   
\$12,800

-  OBARRIO
-  CAJA



REF. 116610

## SUBMARINER NO DATE

-  Acero
-  40 mm
-  Automático

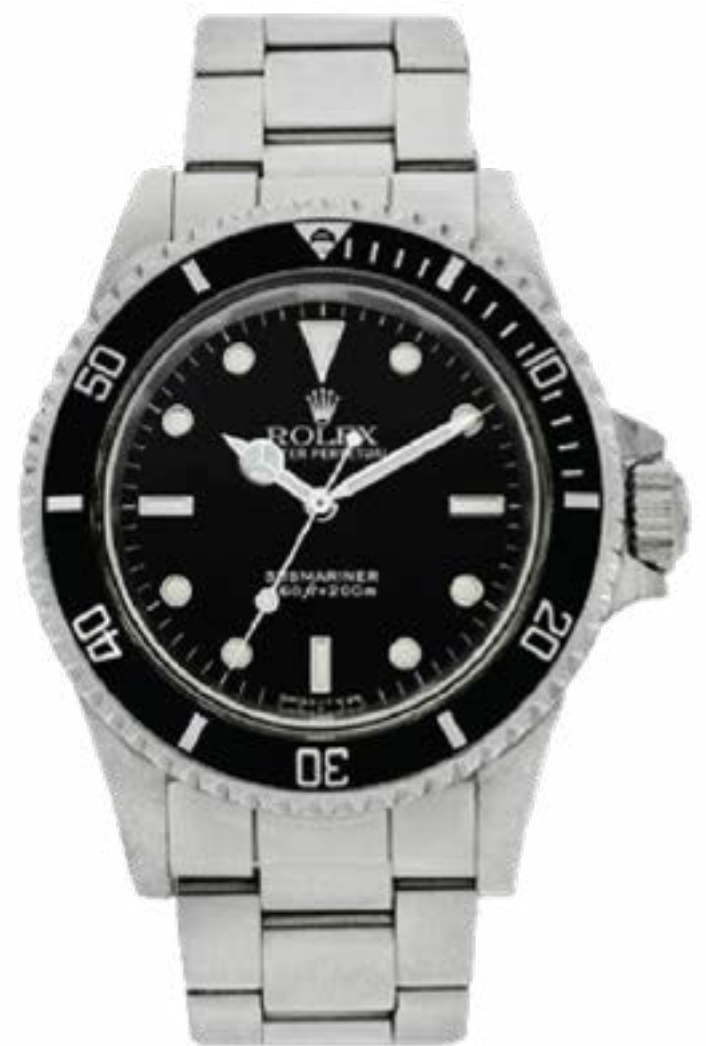

PRECIO   
\$15,000

-  CDE



REF. 5513

## SUBMARINER DATE

-  Acero
-  40 mm
-  Automático



PRECIO   
\$13,000

-  OBARRIO



REF. 116610

## SUBMARINER DATE

-  Acero
-  40 mm
-  Automático

PRECIO   
\$13,500

-  OBARRIO
-  CAJA PAPELES



REF. 116610

AIR KING	DAYTONA	DATEJUST	DAY-DATE	EXPLORER	GMT-MASTER	MILGAUSS
OYSTER PERPETUAL	SEA-DWELLER	SKY-DWELLER	SUBMARINER	YACHT-MASTER	CELLINI	

**SUBMARINER**  
DATE

- Acero
- 40 mm
- Automático

PRECIO   
\$9,800



OBARRIO



REF. 16610



**SUBMARINER**  
DATE

- Acero
- 40 mm
- Automático

PRECIO   
\$10,000



OBARRIO



CAJA



REF. 16610



**SUBMARINER**

- Acero
- 40 mm
- Automático

PRECIO   
\$10,800



CDE



PAPELESCAJA



REF. 16610

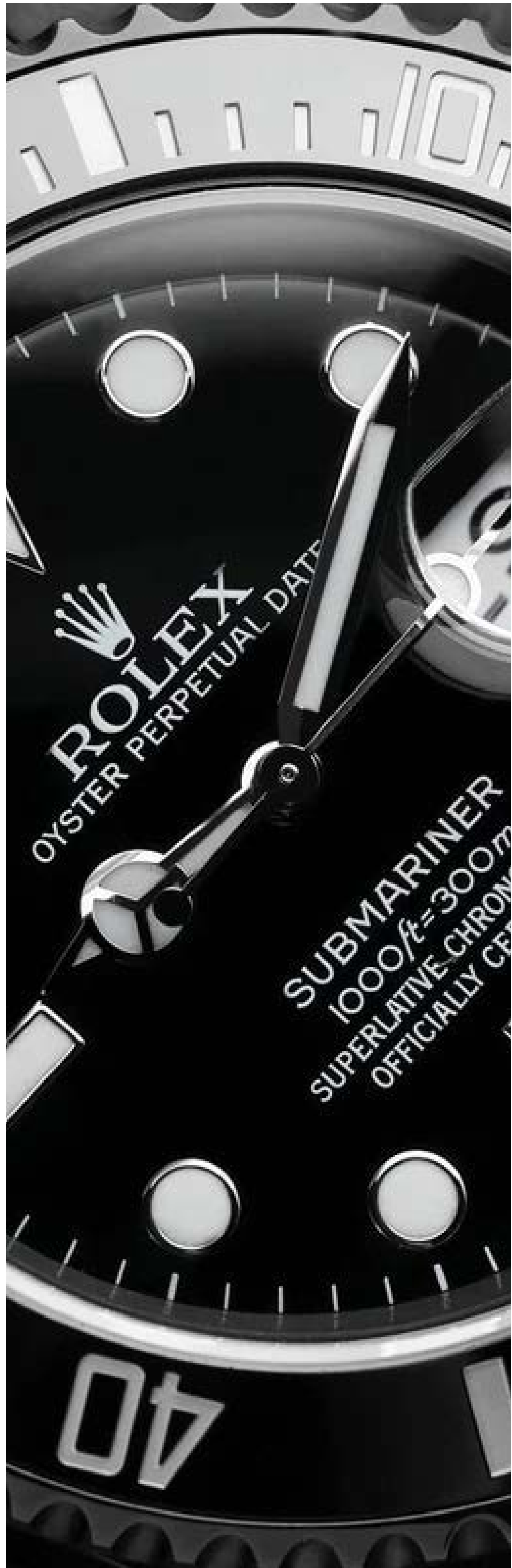

AIR KING	DAYTONA	DATEJUST	DAY-DATE	EXPLORER	GMT-MASTER	MILGAUSS
OYSTER PERPETUAL	SEA-DWELLER	SKY-DWELLER	SUBMARINER	YACHT-MASTER	CELLINI	

**SUBMARINER**



- Acero / Oro
- 40 mm
- Automático

PRECIO \$  
\$12,500



OBARRIO

REF. 16613

**SUBMARINER**



- Acero / Oro
- 40 mm
- Automático

PRECIO \$  
\$13,000



OBARRIO



CAJA

REF. 16613

**SUBMARINER**



- Acero / Oro
- 40 mm
- Automático

PRECIO \$  
\$15,500



OBARRIO

REF. 116613

**SUBMARINER**



- Acero / Oro
- 40 mm
- Automático

PRECIO \$  
\$13,000



OBARRIO



CAJA

REF. 16613

**SUBMARINER**



- Acero / Oro
- 40 mm
- Automático

PRECIO \$  
\$12,500



OBARRIO

REF. 16613

**SUBMARINER**



- Acero / Oro
- 40 mm
- Automático

PRECIO \$  
\$11,000



OBARRIO

REF. 16803

AIR KING	DAYTONA	DATEJUST	DAY-DATE	EXPLORER	GMT-MASTER	MILGAUSS
OYSTER PERPETUAL	SEA-DWELLER	SKY-DWELLER	SUBMARINER	YACHT-MASTER	CELLINI	

**SUBMARINER**

- Acero / Oro
- 40 mm
- Automático

PRECIO   
\$13,000



CDE



REF. 16613

**SUBMARINER**

- Oro
- 40 mm
- Automático

PRECIO   
\$30,500



OBARRIO



REF. 6618T

**SUBMARINER**

- Acero / Oro
- 40 mm
- Automático

PRECIO   
\$12,500



OBARRIO



REF. 16613

**SUBMARINER**

- Acero / Oro
- 40 mm
- Automático

PRECIO   
\$12,500



OBARRIO

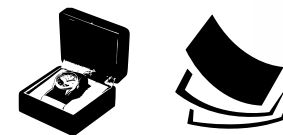

PAPELESCAJA



REF. 16613

**SUBMARINER**

- Acero / Oro
- 40 mm
- Automático

PRECIO   
\$13,000



CDE



REF. 16613

**SUBMARINER**

- Acero / Oro
- 40 mm
- Automático

PRECIO   
\$16,800



OBARRIO

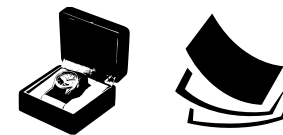



PAPELESCAJA





REF. 116613

AIR KING	DAYTONA	DATEJUST	DAY-DATE	EXPLORER	GMT-MASTER	MILGAUSS
OYSTER PERPETUAL	SEA-DWELLER	SKY-DWELLER	SUBMARINER	YACHT-MASTER	CELLINI	

## SUBMARINER

-  Oro
-  40 mm
-  Automático

PRECIO   
\$38,000

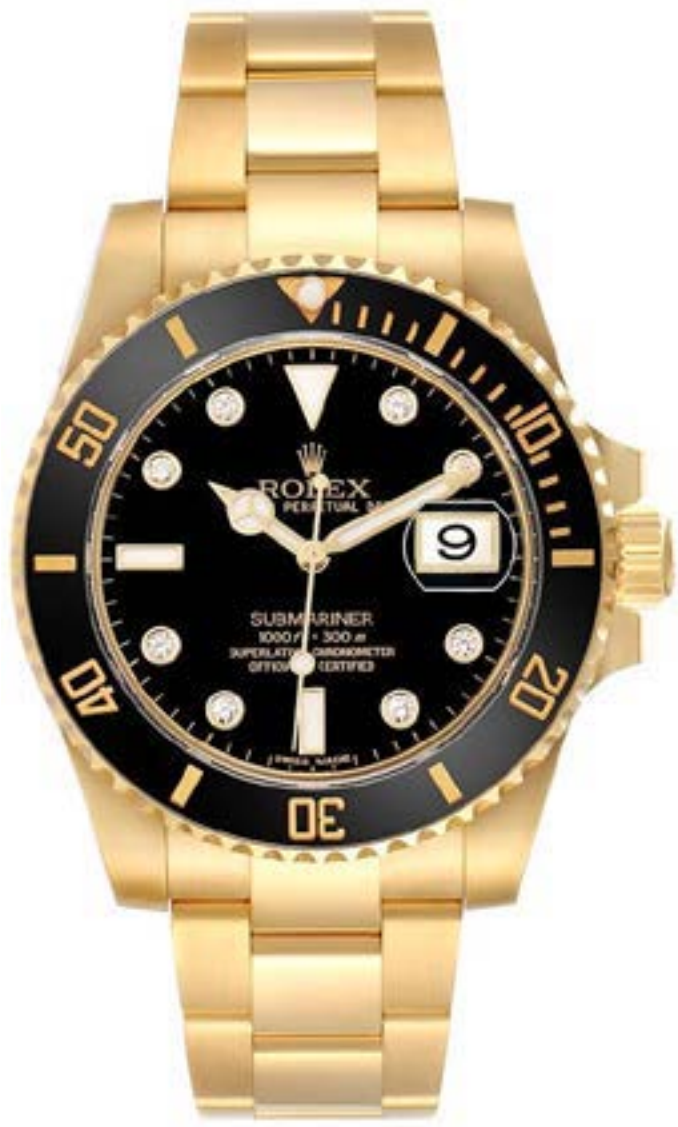

-  OBARRIO
-  PAPELESCAJA



REF. 116618LN



## SUBMARINER

-  Acero / Oro
-  40 mm
-  Automático

PRECIO   
\$16,500

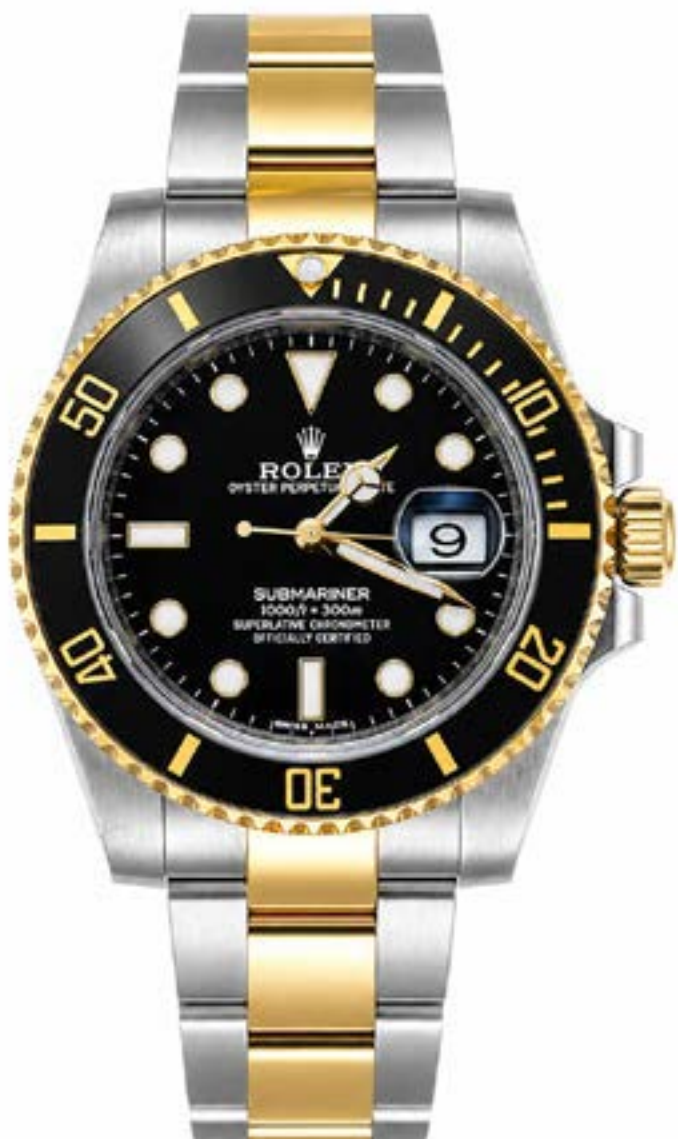

-  OBARRIO
-  PAPELESCAJA



REF. 116613



## SUBMARINER

-  Acero / Oro
-  40 mm
-  Automático

PRECIO   
\$16,500

-  OBARRIO
-  PAPELESCAJA

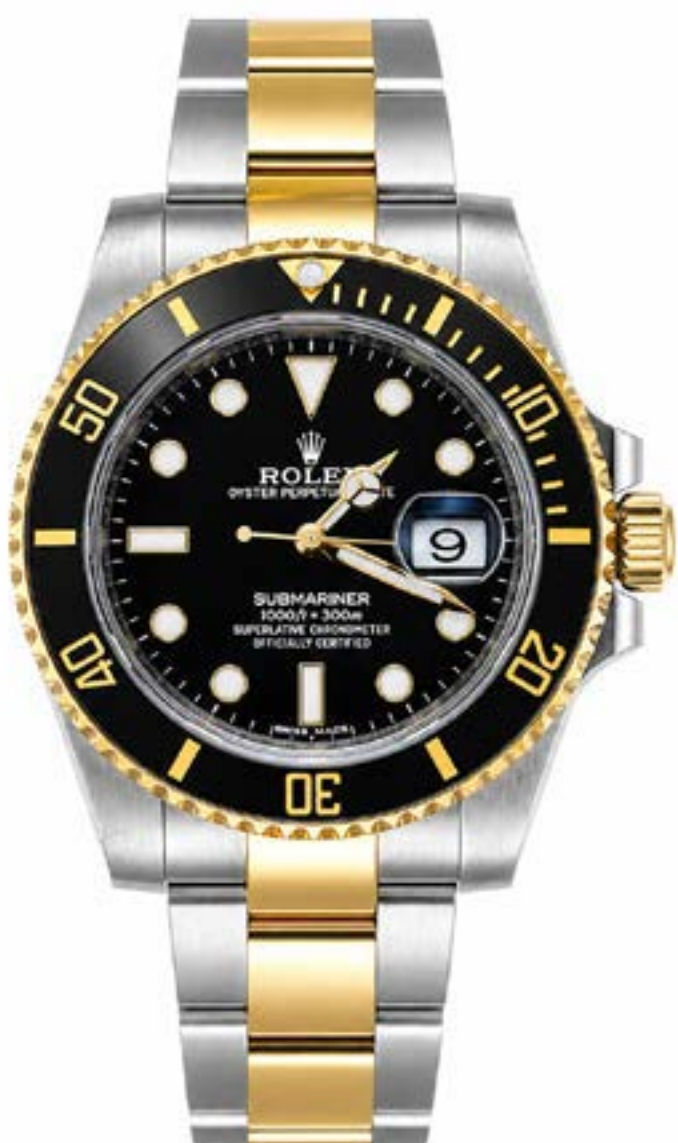



REF. 116613



AIR KING	DAYTONA	DATEJUST	DAY-DATE	EXPLORER	GMT-MASTER	MILGAUSS
OYSTER PERPETUAL	SEA-DWELLER	SKY-DWELLER	SUBMARINER	YACHT-MASTER	CELLINI	

### SUBMARINER "SMURF"

-  Oro Blanco
-  40 mm
-  Automático

PRECIO   
\$38,500



OBARRIO

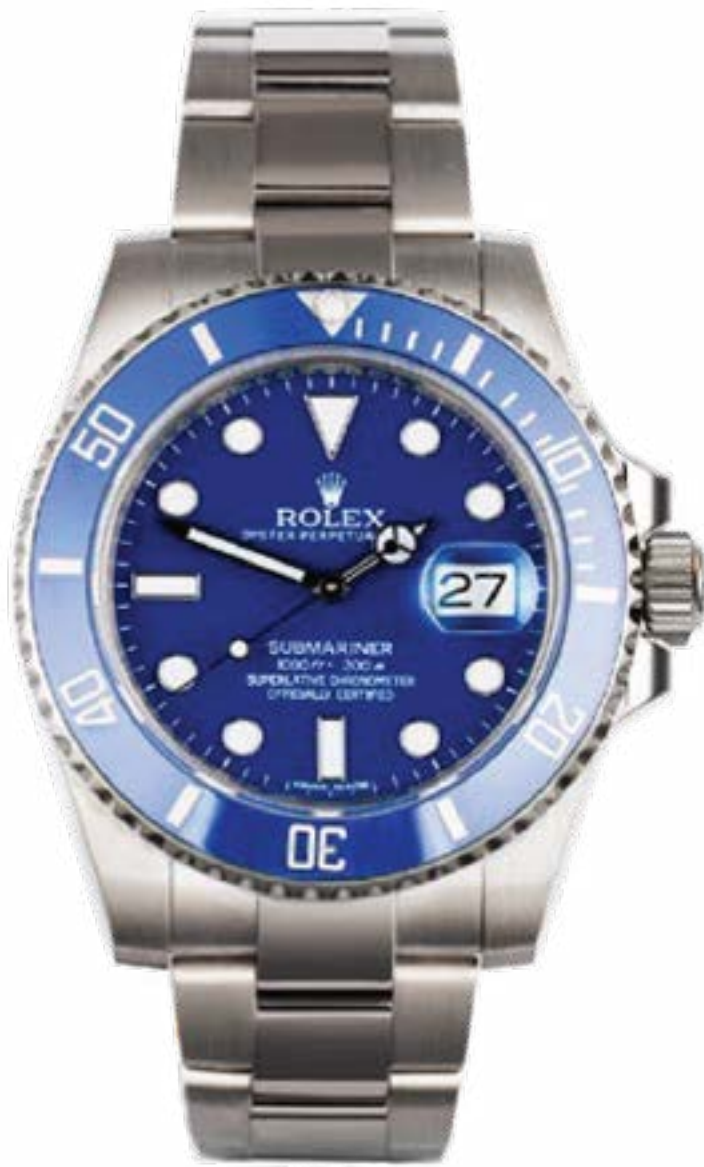

REF. 116619

### "SMURF"



Su distintiva esfera azul intensa y el bisel cerámico Cerachrom a juego le dan una estética única que recuerda a las profundidades marinas, de donde proviene su apodo Smurf (Pitufo).

Equipado con el legendario calibre automático 3135 - reconocido por su fiabilidad, precisión y movimiento certificado como cronómetro - este reloj ofrece función de fecha, resistencia al agua hasta 300 m y un diseño robusto pero elegante, ideal tanto para el buceo profesional como para la muñeca de un coleccionista exigente.



# YACHT-MASTER II



-  Oro Blanco
-  42 mm
-  Automático

PRECIO   
\$32,000

REF. 226659



# YACHT-MASTER II



OBARRIO



 Acero / Oro Rosa

 44 mm

 Automático

PRECIO 

\$23,000



REF. 116681



CAJA

AIR KING	DAYTONA	DATEJUST	DAY-DATE	EXPLORER	GMT-MASTER	MILGAUSS
OYSTER PERPETUAL	SEA-DWELLER	SKY-DWELLER	SUBMARINER	YACHT-MASTER	CELLINI	

## YACHT-MASTER



-  Acero / Oro
-  40 mm
-  Automático

PRECIO   
\$13,500



REF. 16623

## YACHT-MASTER

-  Acero / Oro
-  40 mm
-  Automático

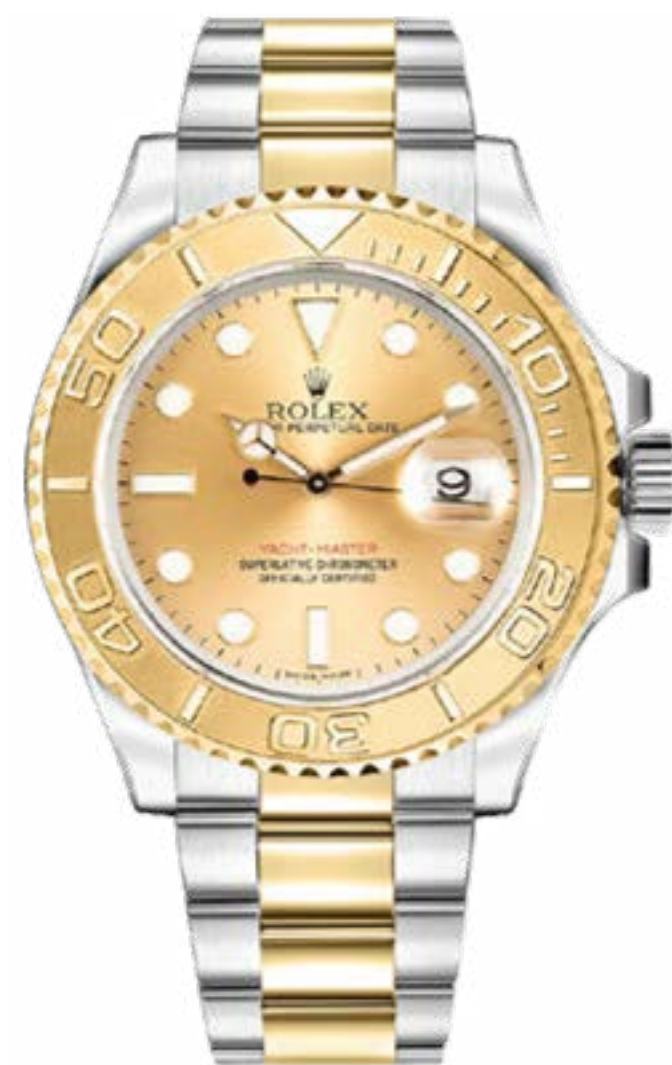

PRECIO   
\$13,800



REF. 16623

## YACHT-MASTER

"SERTI DIAL"

-  Oro
-  40 mm
-  Automático

PRECIO   
\$28,000



REF. 16628

## YACHT-MASTER

"SERTI DIAL"

-  Oro Amarillo 18 k
-  35 mm
-  Automático



PRECIO   
\$20,000



REF. 168628

## YACHT-MASTER

"TAHITIAN DIAL"



-  Oro
-  40 mm
-  Automático

PRECIO   
\$35,000



REF. 16628

## YACHT-MASTER

-  Acero / Oro
-  40 mm
-  Automático

PRECIO   
\$13,800



REF. 168623

AIR KING	DAYTONA	DATEJUST	DAY-DATE	EXPLORER	GMT-MASTER	MILGAUSS
OYSTER PERPETUAL	SEA-DWELLER	SKY-DWELLER	SUBMARINER	YACHT-MASTER	CELLINI	

### YACHT-MASTER II



- Acero / Oro Rosa
- 44 mm
- Automático

PRECIO \$24,500



CDE

REF. 116681

### YACHT-MASTER II



- Acero / Oro Rosa
- 44 mm
- Automático

PRECIO \$22,500



OBARRIO

REF. 116681

### YACHT-MASTER II



- Acero / Oro Rosa
- 44 mm
- Automático

PRECIO \$22,500



OBARRIO

REF. 116681

### YACHT-MASTER II "CANAL DE PANAMÁ"

"EDICIÓN LIMITADA" 150 PIEZAS



- Acero
- 44 mm
- Automático

PRECIO \$25,000



CDE

REF. 116680

### YACHT-MASTER II



- Acero / Oro Rosa
- 44 mm
- Automático

PRECIO \$22,500



OBARRIO

REF. 116681

### YACHT-MASTER II "CANAL DE PANAMÁ"

"EDICIÓN LIMITADA" 150 PIEZAS



- Acero
- 44 mm
- Automático

PRECIO \$23,500



OBARRIO





CAJA PAPELES



REF. 116680

AIR KING	DAYTONA	DATEJUST	DAY-DATE	EXPLORER	GMT-MASTER	MILGAUSS
OYSTER PERPETUAL	SEA-DWELLER	SKY-DWELLER	SUBMARINER	YACHT-MASTER	CELLINI	

## YACHT-MASTER II

-  Acero
-  44 mm
-  Automático



PRECIO   
\$19,500

-  OBARRIO
-  PAPELESCAJA



REF. 116680

## YACHT-MASTER II

-  Acero
-  44 mm
-  Automático

PRECIO   
\$19,000



-  OBARRIO



REF. 116680



## YACHT-MASTER

-  Oro Blanco
-  44 mm
-  Automático



PRECIO   
\$36,000

-  OBARRIO
-  CAJA



REF. 116689

## YACHT-MASTER II

-  Oro Blanco
-  44 mm
-  Automático

PRECIO   
\$38,000



-  OBARRIO
-  PAPELESCAJA



REF. 116689



## YACHT-MASTER II

-  Oro Amarillo
-  44 mm
-  Automático

PRECIO   
\$44,500



-  OBARRIO
-  PAPELESCAJA



REF. 116688

AIR KING	DAYTONA	DATEJUST	DAY-DATE	EXPLORER	GMT-MASTER	MILGAUSS
OYSTER PERPETUAL	SEA-DWELLER	SKY-DWELLER	SUBMARINER	YACHT-MASTER	CELLINI	

## YACHT-MASTER

-  Acero
-  40 mm
-  Automático



PRECIO   
\$9,800



REF. 16622



## YACHT-MASTER

-  Acero
-  40 mm
-  Automático

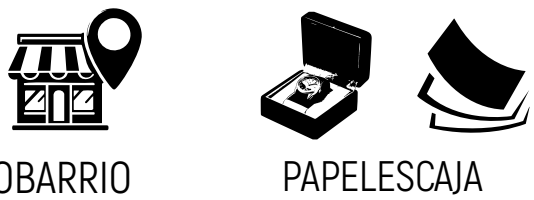

PRECIO   
\$12,500



REF. 16622



## YACHT-MASTER

-  Acero
-  40 mm
-  Automático

PRECIO   
\$13,000

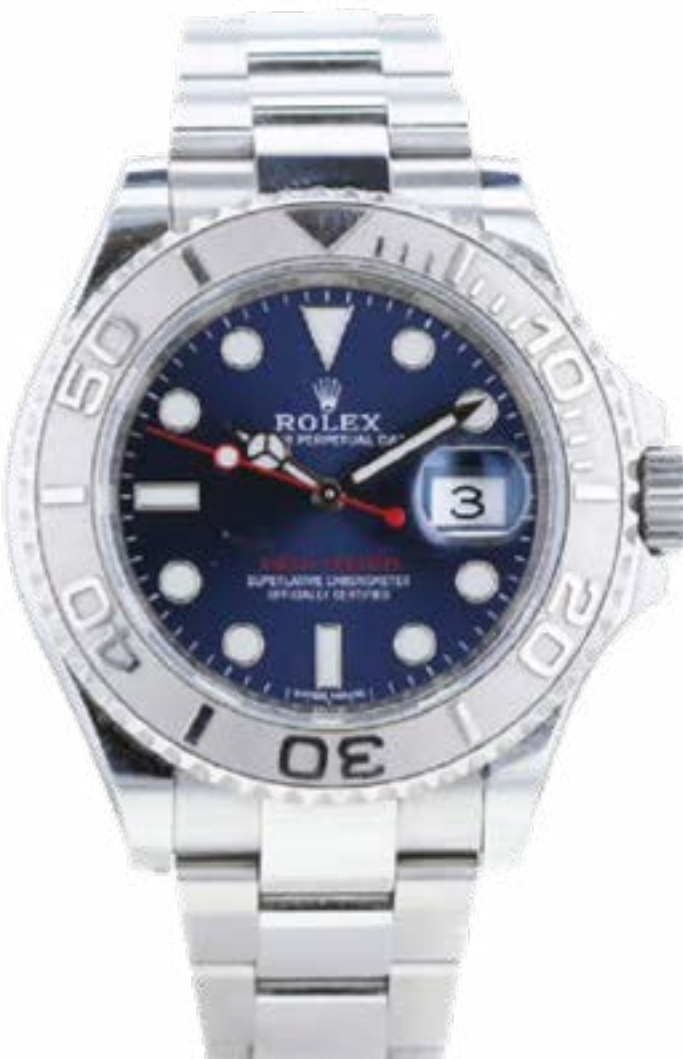

REF. 16622

AIR KING	DAYTONA	DATEJUST	DAY-DATE	EXPLORER	GMT-MASTER	MILGAUSS
OYSTER PERPETUAL	SEA-DWELLER	SKY-DWELLER	SUBMARINER	YACHT-MASTER	CELLINI	

## CELLINI

### SERPICO Y LAINO

"VINTAGE"

-  Oro
-  32 mm
-  Cuerda Manual

PRECIO   
\$5,000



OBARRIO



REF. 8940

## CELLINI

-  Oro Blanco
-  39 mm
-  Cuerda Manual

PRECIO   
\$13,000



CDE



REF. 50509

## CELLINI

### GENEVE

-  Oro Blanco
-  37 mm
-  Quartz

PRECIO   
\$16,500



OBARRIO





PAPELESCAJA



REF. 6623

## CELLINI

-  Oro blanco
-  32 mm
-  Automático

PRECIO   
\$5,500





OBARRIO



REF. 5116

## CELLINI

-  Oro Amarillo
-  25 mm
-  Quartz

PRECIO   
\$20,000



OBARRIO





PAPELESCAJA



REF. 5218

## PRECISION

### VINTAGE

-  Acero/Oro/Diamantes
-  16 mm
-  Quartz

PRECIO   
\$12,800



OBARRIO



REF. VINTAGE

AIR KING	DAYTONA	DATEJUST	DAY-DATE	EXPLORER	GMT-MASTER	MILGAUSS
OYSTER PERPETUAL	SEA-DWELLER	SKY-DWELLER	SUBMARINER	YACHT-MASTER	CELLINI	

## ORCHID



 Oro / Diamantes

 19 x 24 mm

 Cuerda Manual

PRECIO 

\$8,200



OBARRIO



PAPELESCAJA

REF.

ORCHID





**TAGHeuer**  
SWISS AVANT-GARDE SINCE 1860

Destacada por su precisión, innovación y estrecha relación con el automovilismo, TAG Heuer es una reconocida casa suiza de alta relojería, sus colecciones icónicas, como Carrera y Monaco, reflejan un enfoque técnico orientado al rendimiento y la medición del tiempo.

A lo largo de su historia, la marca ha impulsado avances en cronografía y diseño deportivo, consolidándose como un referente en relojería contemporánea.

AARON  JOYEROS



**TAGHeuer**  
SWISS AVANT-GARDE SINCE 1860

## AQUARACER

-  Acero
-  43 mm
-  Automático

PRECIO   
\$1,800



OBARRIO



REF. CAK2110.BA0833





**TAGHeuer**  
SWISS AVANT-GARDE SINCE 1860



ÍNDICE

AQUARACER	CARRERA	FÓRMULA	LINK	MONZA	MÓNACO
MOP DIAMOND	CHRONOMETER	PROFESSIONAL			



 Acero / Oro

 43 mm

 Automático

REF.

PRECIO 

\$2,600

# AQUARACER



AQUARACER	CARRERA	FÓRMULA	LINK	MONZA	MÓNACO
MOP DIAMOND	CHRONOMETER	PROFESSIONAL			

## AQUARACER

Acero y Oro

27 mm

Quartz

PRECIO

\$850



OBARRIO



REF. WAF1420



## AQUARACER

Acero

43 mm

Quartz

PRECIO

\$1,200



OBARRIO



REF. CAY1110.BA0927





**TAGHeuer**  
SWISS AVANT-GARDE SINCE 1860

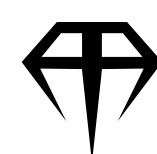

ÍNDICE

AQUARACER	CARRERA	FÓRMULA	LINK	MONZA	MÓNACO
MOP DIAMOND	CHRONOMETER	PROFESSIONAL			

# CARRERA

 Acero

 39 mm

 Automático

PRECIO   
2,300

REF WBN2112.BA0639



CAJA



PAPELES



CDE





**TAGHeuer**  
SWISS AVANT-GARDE SINCE 1860

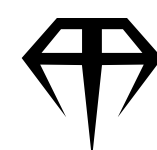

ÍNDICE

AQUARACER	CARRERA	FÓRMULA	LINK	MONZA	MÓNACO
MOP DIAMOND	CHRONOMETER	PROFESSIONAL			

# CARRERA TITAN



OBARRIO



Titanio y Oro



45 mm



Automático

PRECIO   
\$5,400



**TAGHeuer**  
SWISS AVANT-GARDE SINCE 1860

REF.

CAR2A5A.FT6044



**TAGHeuer**  
SWISS AVANT-GARDE SINCE 1860

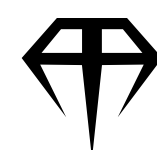

ÍNDICE

AQUARACER	CARRERA	FÓRMULA	LINK	MONZA	MÓNACO
MOP DIAMOND	CHRONOMETER	PROFESSIONAL			

# CARRERA



- Acero / Oro
- 41 mm
- Automático

PRECIO \$3,000

OBARRIO

REF CV2050-1



**TAG Heuer**  
SWISS AVANT-GARDE SINCE 1860



ÍNDICE

AQUARACER	CARRERA	FÓRMULA	LINK	MONZA	MÓNACO
MOP DIAMOND	CHRONOMETER	PROFESSIONAL			

## CARRERA



REF. CAR2014.FC6235

- Acero
- 43 mm
- Automático

PRECIO

\$2,200

- OBARRIO
- PAPELESCAJA

## GRAND CARRERA CHRONOGRAPH



REF. CAV518B

- Acero
- 43 mm
- Automático

PRECIO

\$3,600

- OBARRIO

## CARRERA

"Skeleton Black Dial"



REF. CAR201V.FT6087

- Acero
- 43 mm
- Automático

PRECIO

\$3,000

- OBARRIO
- PAPELES

## CARRERA



REF. WAR5010.BA0723

- Acero
- 41 mm
- Automático

PRECIO

\$2,200

- OBARRIO
- PAPELES

## CARRERA



REF. WBN2010

- Acero
- 41 mm
- Automático

PRECIO

\$3,000

- OBARRIO
- PAPELESCAJA

## CARRERA CALIBRE 8 GMT



REF. WAR5010.BA0723

- Acero
- 41 mm
- Automático

PRECIO

\$2,300

- OBARRIO



**TAG Heuer**  
SWISS AVANT-GARDE SINCE 1860

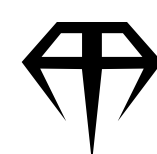

ÍNDICE

AQUARACER	CARRERA	FÓRMULA	LINK	MONZA	MÓNACO
MOP DIAMOND	CHRONOMETER	PROFESSIONAL			

## CARRERA CHRONOGRAPH

- Acero
- 42 mm
- Automático

PRECIO

\$3,800



OBARRIO



REF. OBN2010

## GRAND CARRERA

- Acero
- 42.5 mm
- Automático

PRECIO

\$2,350



CDE



REF. WAV5112.BA0901

## CARRERA

- Acero
- 41 mm
- Automático

PRECIO

\$3,000



OBARRIO



PAPELESCAJA



REF. WBN2013.FC6503

## CARRERA

- Acero
- 41 mm
- Automático

PRECIO

\$2,200



OBARRIO



REF. WBN2013.FC6503

## CARRERA

- Acero
- 39 mm
- Automático

PRECIO

\$1,800



OBARRIO



REF. WAS2112.FC6181

## CARRERA

- Acero
- 43 mm
- Automático

PRECIO

\$3,200



OBARRIO



REF. CAR2A80



**TAGHeuer**  
SWISS AVANT-GARDE SINCE 1860



# FÓRMULA 1



REF. CAZ101N.FC8243

-  Acero
-  43 mm
-  Quartz

PRECIO   
\$1,500



**TAGHeuer**  
SWISS AVANT-GARDE SINCE 1860



WBY1111.BA0042



Acero



38 mm



Quartz

PRECIO



\$1,550



PAPELESCAJA



OBARRIO

# FÓRMULA 1 SOLARGRAPH

AARON  JOYEROS



**TAGHeuer**  
SWISS AVANT-GARDE SINCE 1860



ÍNDICE

AQUARACER	CARRERA	FÓRMULA	LINK	MONZA	MÓNACO
MOP DIAMOND	CHRONOMETER	PROFESSIONAL			



# FÓRMULA 1

REF CAH1111.BA0850

- Acero
- 41 mm
- Quartz

PRECIO \$1,300



**TAG Heuer**  
SWISS AVANT-GARDE SINCE 1860

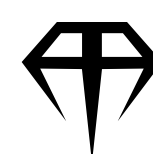

ÍNDICE

AQUARACER	CARRERA	FÓRMULA	LINK	MONZA	MÓNACO
MOP DIAMOND	CHRONOMETER	PROFESSIONAL			

## FÓRMULA 1 LADY

- Acero/Diamantes
- 37 mm
- Quartz

PRECIO   
\$2,100



OBARRIO



REF. WAC1218.BA0852

## FÓRMULA 1

- Acero y Cerámica
- 41 mm
- Automático

PRECIO   
\$1,400



OBARRIO



REF. CAH1213

## FÓRMULA 1 - LADY

- Acero
- 32 mm
- Quartz

PRECIO   
\$1,200



OBARRIO



REF. WBJ1418

## FÓRMULA 1

- Acero/Diamantes
- 37 mm
- Automático

PRECIO   
\$2,500



OBARRIO

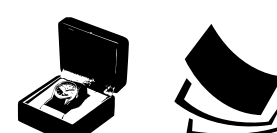

PAPELESCAJA



REF. WAU2213

## FÓRMULA 1 DAVID GUETTA

- Acero / Cuero
- 43 mm
- Automático

PRECIO   
\$2,000



OBARRIO



CAJA



REF. WAZ201A

## FÓRMULA 1 - LADY

- Acero
- 36 mm
- Quartz

PRECIO   
\$2,000



OBARRIO



REF. WAC1216-0



**TAGHeuer**  
SWISS AVANT-GARDE SINCE 1860

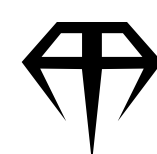

ÍNDICE

AQUARACER	CARRERA	FÓRMULA	LINK	MONZA	MÓNACO
MOP DIAMOND	CHRONOMETER	PROFESSIONAL			



# LINK

## CALIBRE

- Acero
- 42 mm
- Automático

PRECIO \$1,500



T2011.BA0951

OBARRIO



**TAG Heuer**  
SWISS AVANT-GARDE SINCE 1860

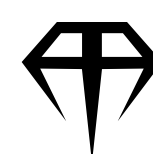

ÍNDICE

AQUARACER	CARRERA	FÓRMULA	LINK	MONZA	MÓNACO
MOP DIAMOND	CHRONOMETER	PROFESSIONAL			

## MONZA

CALIBRE 17

Acero / Cerámica

42 mm

Automático

PRECIO

\$4,000



OBARRIO



REF. CR2080

## MÓNACO

Acero / Cuero

41 mm

Automático

PRECIO

\$4,200



OBARRIO



REF. WW2114

## MOP DIAMOND

"DIAL MADRE PERLA"

Acero

28 mm

Quartz

PRECIO

\$1,200



OBARRIO



REF. WP131C

## CHRONOMETER

Acero

38 mm

Automático

PRECIO

\$900



OBARRIO



REF. WH5115-KT

## PROFESSIONAL

Acero

37 mm

Quartz

PRECIO

\$600



OBARRIO



REF. WL1112.BA0701

## PROFESSIONAL

Acero

37 mm

Quartz

PRECIO

\$950



OBARRIO



REF. WK1112



# TIFFANY & Co.

Tiffany & Co. es una icónica casa de lujo reconocida por su elegancia atemporal y su legado en la alta joyería. En relojería, sus creaciones combinan diseño sofisticado con precisión, reflejando un estilo refinado y distintivo.

Tiffany & Co. representa exclusividad, buen gusto y tradición dentro del universo del lujo.

# ATLAS DOME



OBARRIO



ACERO/CUERO

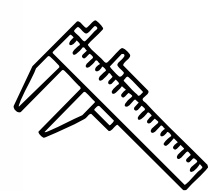

31 mm

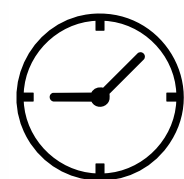

Quartz

PRECIO   
\$1,500

REF.

Z1831.11.10B10A40A



## TIFFANY & CO. CLASSIC

 Oro

 35 mm

 Automático

PRECIO 

\$5,000



OBARRIO



REF.

M253







**T+**  
**TISSOT**

Tiffany & Co. es una icónica casa de lujo reconocida por su elegancia atemporal y su legado en la alta joyería. En relojería, sus creaciones combinan diseño sofisticado con precisión, reflejando un estilo refinado y distintivo.

Tiffany & Co. representa exclusividad, buen gusto y tradición dentro del universo del lujo.

AARON  JOYEROS

## PRS 516

-  Acero
-  42 mm
-  Automático

PRECIO   
\$950



OBARRIO



CAJA



REF. T100.430.16.051.00





# TUDOR

Tudor es una destacada casa suiza reconocida por ofrecer relojería de alto rendimiento con un enfoque robusto y accesible dentro del lujo. Sus modelos, inspirados en la herencia de su marca matriz, combinan fiabilidad, diseño deportivo y excelente relación calidad-precio.



Tudor representa resistencia, precisión y espíritu aventurero en la relojería contemporánea.

AARON  JOYEROS



  
**TUDOR**

# BLACK BAY

-  Cerámica y Acero
-  41 mm
-  Automático

PRECIO   
\$3,850

   
PAPELESCAJA

REF. M79210CNU-0001

  
OBARRIO



# DOUBLE DATE



CAJA



PAPELES



Acero



42 mm



Automático



OBARRIO

REF.

M57100-0001

PRECIO

\$3,000



# U-BOAT

U-Boat es una firma italiana reconocida por su diseño audaz y de gran tamaño, inspirado en instrumentos militares y de buceo. Sus relojes destacan por cajas robustas, coronas distintivas y una estética vintage-industrial muy marcada.

U-Boat representa carácter, originalidad y una presencia contundente dentro de la relojería contemporánea.

**U-BOAT**

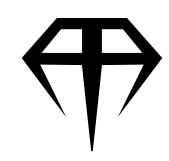

ÍNDICE

# CLASSICO



Acero



53 mm



Automático

PRECIO



\$1,800

REF.

55780



OBARRIO



AARON  JOYEROS



**ULYSSE NARDIN**  
SINCE 1846  LE LOCLE - SUISSE

Ulysse Nardin es una histórica manufactura suiza reconocida por su innovación técnica y su estrecha relación con la navegación marina. Sus relojes destacan por la precisión, el desarrollo de complicaciones y el uso de tecnologías avanzadas.

Ulysse Nardin representa tradición, ingeniería y espíritu explorador dentro de la alta relojería.

**AARON  JOYEROS**

## MARINE

- Acero / Caucho
- 40 mm
- Automático

PRECIO   
\$4,000



REF. 263-33

## SAN MARCO

- Acero
- 38.5 mm
- Automático

PRECIO   
\$3,000



REF. 433-77

## MAXI MARINE

- Acero
- 41 mm
- Automático

PRECIO   
\$3,800



REF. 353-66-314

## DIVER

- Acero
- 44 mm
- Automático

PRECIO   
\$7,000



REF. 1183-170-3/92



## VACHERON CONSTANTIN

Vacheron Constantin es una de las manufacturas más antiguas y prestigiosas de la alta relojería, reconocida por su excelencia artesanal, precisión y tradición ininterrumpida. Sus creaciones destacan por el desarrollo de complicaciones y acabados de alto nivel.

Vacheron Constantin representa elegancia, maestría y herencia dentro del universo más exclusivo de la relojería.



# OVERSEAS

ORO AMARILLO

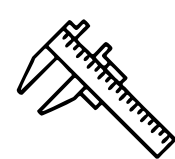

37 mm

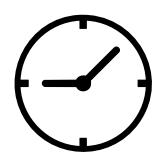

AUTOMÁTICO

PRECIO   
\$18,000



OBARRIO



REF. 2042/000J-8966



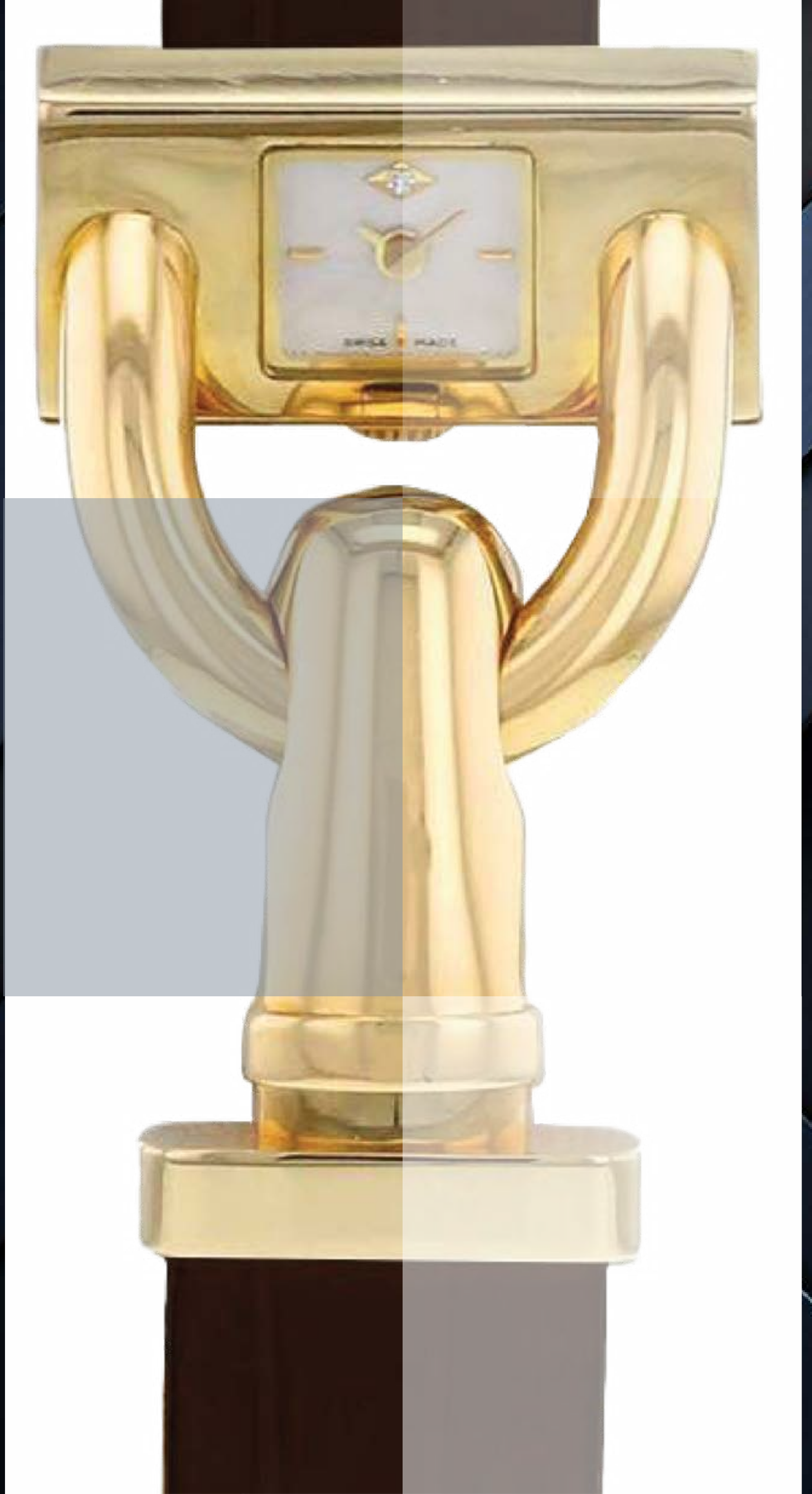

## Van Cleef & Arpels

Chopard es una reconocida casa suiza que combina alta relojería y joyería con un enfoque en la elegancia, la innovación y la artesanía. Sus creaciones destacan por la atención al detalle y el uso de materiales de alta calidad.

A lo largo de su trayectoria, la marca ha desarrollado colecciones icónicas que equilibran técnica y estética, consolidando su presencia en el mundo del lujo. Chopard representa refinamiento, creatividad y excelencia dentro del universo relojero.



## CÁRDENAS

 Oro Amarillo

 26 x 14 mm

 Quartz

PRECIO   
\$9,700

  
CDE



REF. 371505



# Vintage

Esta selección de relojería vintage rinde tributo a la era dorada de la mecánica, donde la precisión y el arte se fusionaban en piezas de valor eterno. Estos ejemplares destacan por su manufactura artesanal en metales nobles y esferas de porcelana. Cada reloj de esta colección es un testimonio del ingenio humano, conservando la elegancia clásica que trasciende las modas pasajeras. Son joyas mecánicas que representan la máxima sofisticación de una época donde cada segundo se medía con distinción.

# Vintage

## WALTHAM

VINTAGE

Colección personal de Juan Vicente Gómez, representa la unión entre la precisión industrial y el poder político de principios del siglo XX. Con su esfera de porcelana blanca y caja de alta gama, esta pieza personifica la estética de sobriedad y mando que caracterizó al "Benemérito". Más que un instrumento para medir el tiempo, el ejemplar es un testigo patrimonial de la historia venezolana y de la fiabilidad técnica de una era dorada en la relojería norteamericana.

ORO 18k

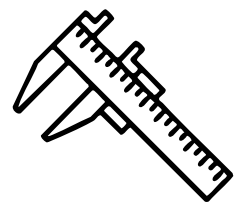

48 mm

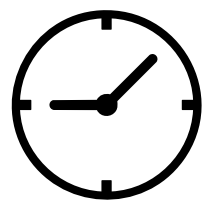

Cuerda manual

PRECIO



\$20,000



REF.

VINTAGE



OBARRIO

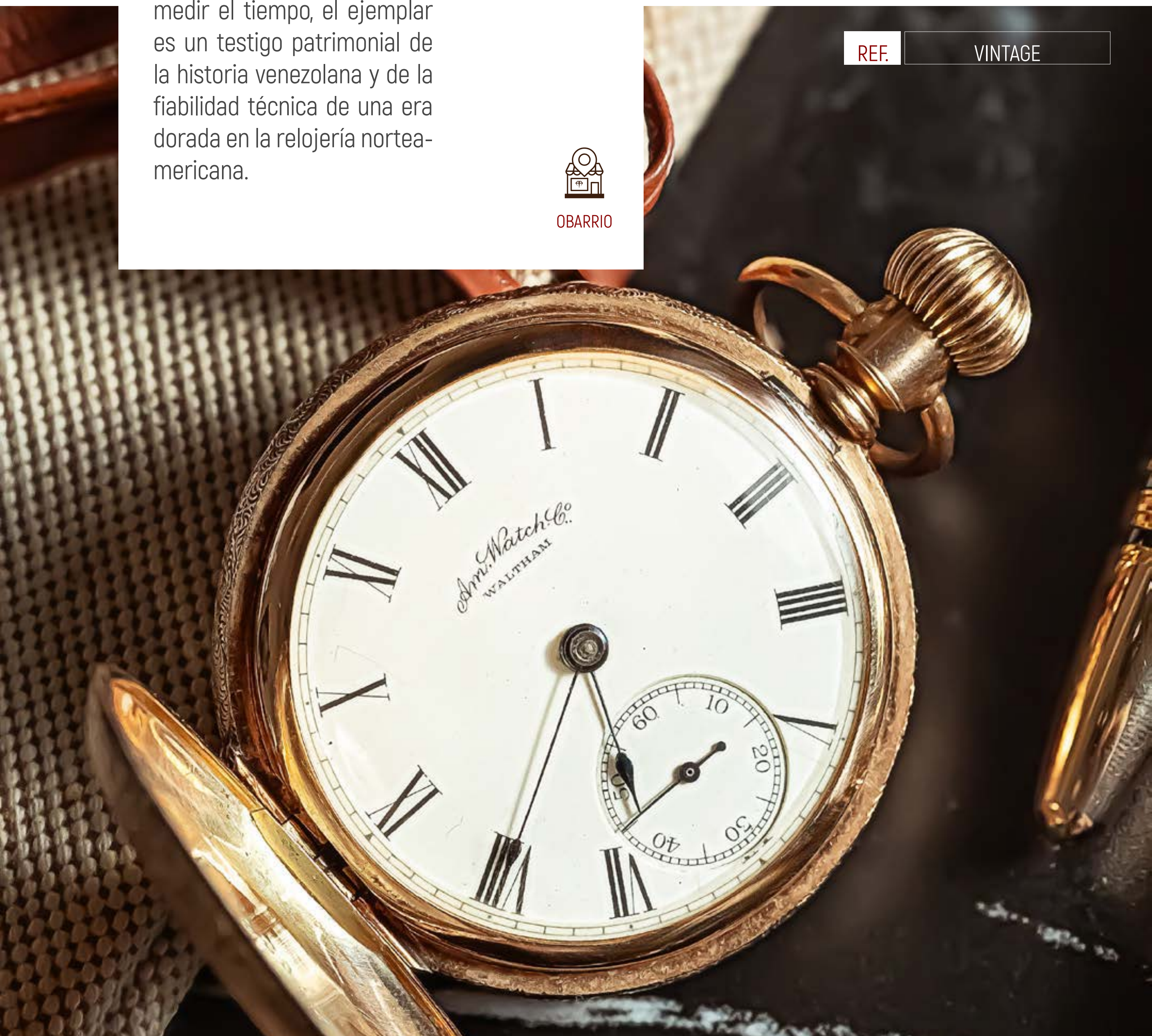

## OMEGA VINTAGE

- Acero
- 41 mm
- Quartz

PRECIO \$  
\$1,500



OBARRIO



REF. VINTAGE

## TUDOR VINTAGE

- Acero
- 17 mm
- Automático

PRECIO \$  
\$800



OBARRIO



REF. VINTAGE

## PRECISION VINTAGE

- Acero/Oro/Diamantes
- 16 mm
- Quartz

PRECIO \$  
\$12,800



OBARRIO



REF. VINTAGE

## OMEGA VINTAGE

"STRAP AFTER MARKET"

- Oro Rosa
- 36 mm
- Automático

PRECIO \$  
\$4,000



OBARRIO



REF. VINTAGE

## OMEGA CONSTELLATION

- Oro Amarillo
- 35 mm
- Quartz

PRECIO \$  
\$4,000



OBARRIO



REF. 2652 SC

## SEAMASTER DYNAMIC

"BISEL ORO"

- Acero
- 34 mm
- Quartz

PRECIO \$  
\$1,000



OBARRIO



REF. 96.0301 396.0993

## PIAGET CUERVOS Y SOBRINOS



REF. VINTAGE

- Acero
- 32 mm
- Automático

PRECIO   
\$500



OBARRIO

## LONGINES



REF. 1940

- Oro
- 32 mm
- Quartz

PRECIO   
\$3,500



OBARRIO



CAJA

## SEAMASTER VINTAGE



REF. VINTAGE

- Oro Amarillo
- 34 mm
- Quartz

PRECIO   
\$3,500



OBARRIO

## SEAMASTER 1970

"DIAL SPIDER"



REF. 166.073

- Acero
- 43 x 46 mm
- Automático

PRECIO   
\$9,000



OBARRIO

## MUST VERMEIL 925



REF. 590004

- Oro Amarillo
- 24 mm
- Quartz

PRECIO   
\$1,900



OBARRIO

# Diamantes



Presentamos una cuidada selección de diamantes elegidos bajo los más altos estándares de calidad, pureza y proporción. Cada piedra ha sido evaluada por su brillo, simetría y transparencia, garantizando una presencia que deslumbra a primera vista.

Nuestra colección equilibra corte, color, claridad y quilataje, asegurando no solo belleza excepcional, sino también valor y permanencia en el tiempo. Más que una muestra de gemas, es una invitación a invertir con criterio y crear piezas destinadas a trascender generaciones.

Aquí comienza su próxima gran elección.



# DIAMANTES

01/02



REDONDO

CT 1.06  
COLOR J/K  
CLARIDAD VS2

PRECIO   
\$4,150

OBARRIO



REDONDO

CT 0.44  
COLOR K/L  
CLARIDAD SI1

PRECIO   
\$650

OBARRIO



REDONDO

CT 0.22  
COLOR  
CLARIDAD

PRECIO   
\$2,000

OBARRIO



REDONDO

 **GIA**   
CT 1.30 L, FAINT  
COLOR BROWN VVS2  
CLARIDAD

PRECIO   
\$3,300

OBARRIO



REDONDO

CT 1.20  
COLOR  
CLARIDAD

PRECIO   
\$3,800

OBARRIO



PRINCESS CUT

CT 1.60  
COLOR H  
CLARIDAD i2

PRECIO   
\$5,000

OBARRIO



# DIAMANTES

02/02



REDONDO

CT 1.64  
COLOR G  
CLARIDAD VS2

PRECIO   
\$12,000

OBARRIO



RADIANT CUT



CT 2.19  
COLOR F  
CLARIDAD vvs1

PRECIO   
\$22,000

OBARRIO



REDONDO

CT 0.75  
COLOR J  
CLARIDAD VS1

PRECIO   
\$2,500

OBARRIO



REDONDO

CT 1.735  
COLOR m  
CLARIDAD si1

PRECIO   
\$3,500

OBARRIO



CUSHION CUT

CT 0.87  
COLOR fancy  
CLARIDAD yellow

PRECIO   
\$4,500

OBARRIO



CUSHION CUT



CT 2.13  
COLOR f  
CLARIDAD vs1

PRECIO   
\$19,800

COSTA DEL ESTE



# BOLÍGRAFOS

Una colección creada para quienes ven la escritura como una **expresión de estilo y personalidad**. Cada pieza combina precisión, equilibrio y diseño refinado para ofrecer una experiencia superior en cada trazo.

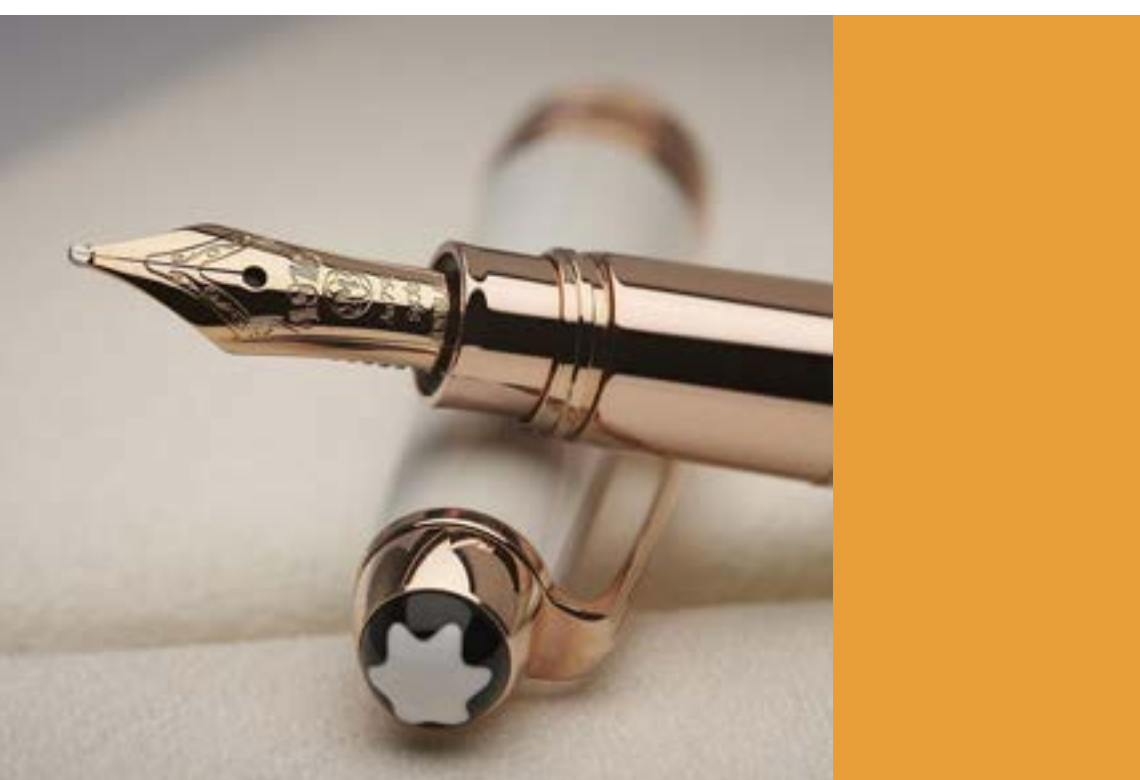

AARON  JOYEROS

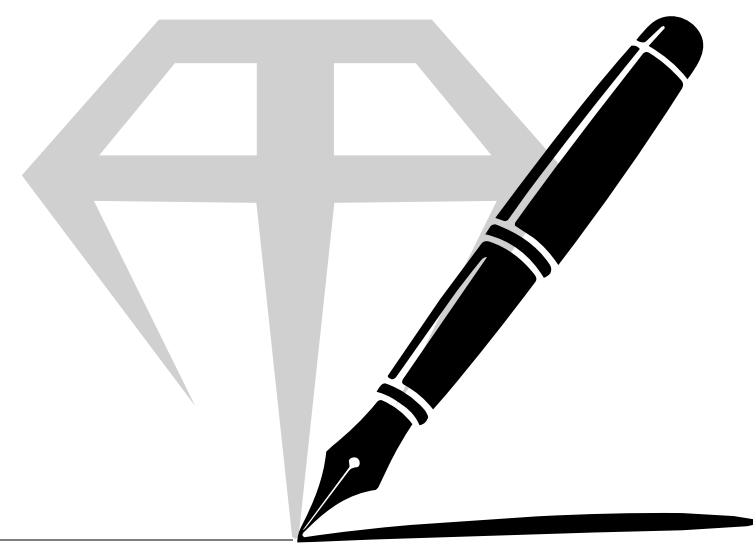

# BOLÍGRAFOS

HOMENAJE A

ROBERT LOUIS STEVENSON



# MONTBLANC

EDICIÓN LIMITADA



CAJA



PAPELES

Este exclusivo bolígrafo, inspirado en el espíritu aventurero y literario de Robert Louis Stevenson, combina elegancia clásica con detalles náuticos y artesanales. Su acabado en tonos dorados, grabados refinados y elementos inspirados en la exploración reflejan la esencia del autor de **La Isla del Tesoro**. Una pieza de colección que une escritura, historia y lujo en un diseño sofisticado y atemporal.

PRECIO   
\$5,700



OBARRIO

AARON  JOYEROS

BOLÍGRAFOS



MONT  
BLANC



# JOHN LENNON

**TIPO** | ROLLERBALL

PRECIO   
\$1,400



# JOHN LENNON

**TIPO** | FUENTE

PRECIO   
\$1,400



BOLÍGRAFOS

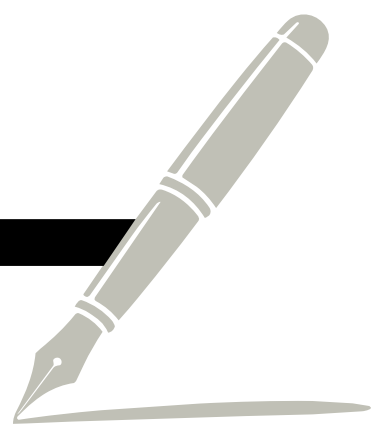

MONT  
BLANC



# MAHATMA GANDHI

TIPO | ESTILOGRÁFICA



PAPELESCAJA

PRECIO   
\$2,200



# PRINCESSE

## Grace de Mónaco

TIPO | ROLLERBALL

PRECIO   
\$600



CAJA



PAPELES

MONT  
BLANC



AARON  JOYEROS



BOLÍGRAFOS

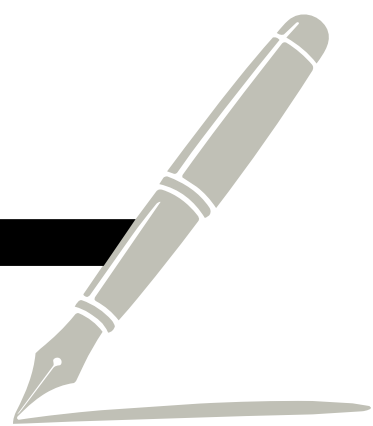

**MONT  
BLANC**

**HENRY E. STEINWAY**

**TIPO** | ESTILOGRÁFICA



Mecenas del Arte  
Steinway 4810

Esta pluma rinde homenaje a Henry E. Steinway, fundador de Steinway & Sons y revolucionario de la fabricación de pianos en el siglo XIX. Montblanc la incluyó en su colección Patron of Art, combinando inspiración musical con alta artesanía en escritura.

**PRECIO**   
\$3,000



PAPELESCAJA

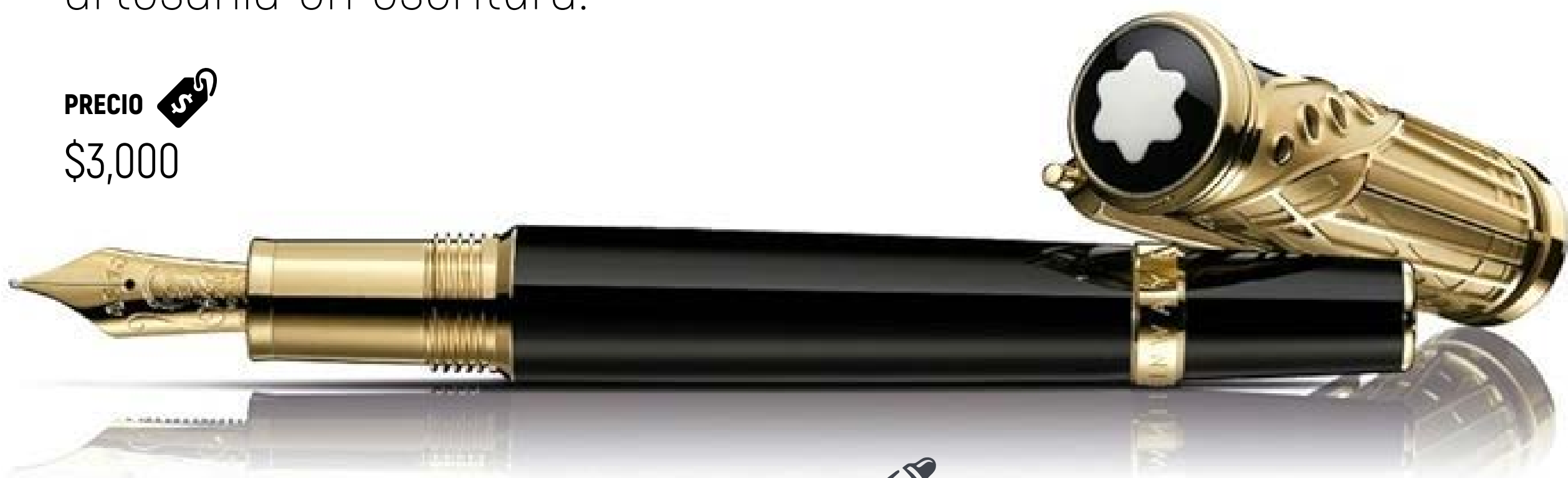

AARON  JOYEROS



**EDITION**  
LEO TOLSTOY

**TIPO** | BALLPOINT

**PRECIO**   
\$3,500



CAJA

**EDITION** LEO  
TOLSTOY **TIPO** |  
BALLPOINT

**PRECIO**  
\$2,600



PAPELES

**MONT**   
**BLANC**



BOLÍGRAFOS

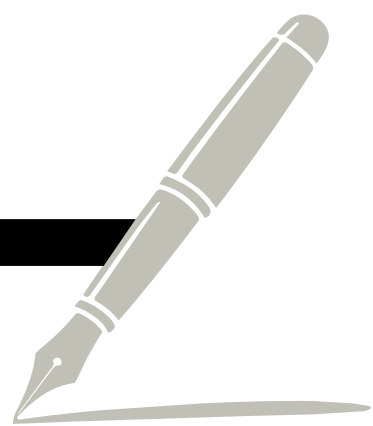

**MONT  
BLANC** 

# GEORGE BERNARD SHAW

EDICIÓN LIMITADA

**TIPO** | BALLPOINT



PAPELESCAJA



**PRECIO**   
\$1,500

## EDICIÓN MEISTERSTÜCK

**TIPO** | ROLLERBALL

**PRECIO**   
\$700



AARON  JOYEROS

BOLÍGRAFOS

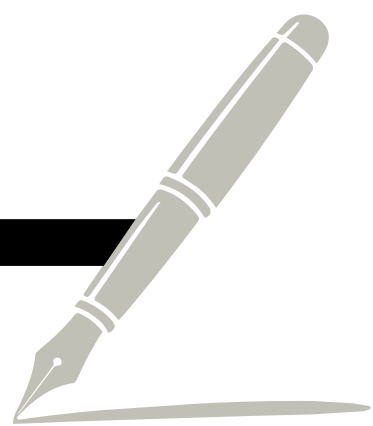

**MONT  
BLANC** 



MEISTERSTÜCK

**TIPO** | BALLPOINT

PRECIO   
\$300

MEISTERSTÜCK

**TIPO** | RESALTADOR 

PRECIO   
\$220

CAJA



AARON  JOYEROS

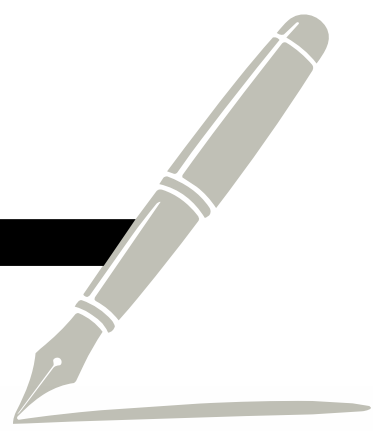

# MONT BLANC

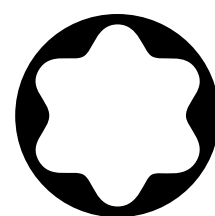

## STARWALKER

**TIPO** | ESTILIGRÁFICA

**PRECIO**   
\$300



## MEISTERSTÜCK

**TIPO** | BALLPOINT

**PRECIO**   
\$400



## MEISTERSTÜCK

**TIPO** | BALLPOINT Solitaire Douè

**PRECIO**   
\$1,400





LE MUST PHANTERE

TIPO | ESTILIGRÁFICA

PRECIO   
\$1,200



DIABOLO

Cartier

TIPO | BALLPOINT

PRECIO   
\$600



MONT  
BLANC 

TIPO  
Bohème  
Rollerball

PRECIO   
\$650



WATERMAN  
PARIS

TIPO  
EDSON  
FUENTE

PRECIO   
\$120



 PILOT

TIPO  
BLACK  
CARBONESQUE  
FUENTE

PRECIO   
\$120



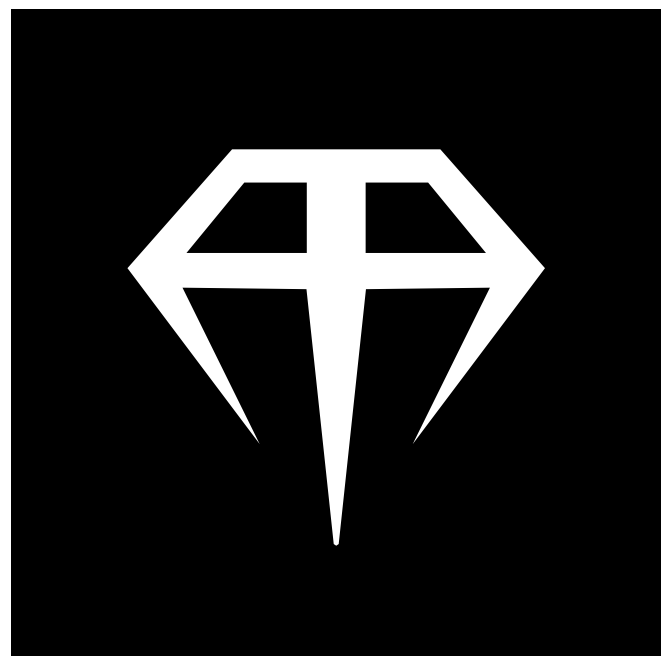

# Mancuernas

01

## Clásicos Atemporales

Siluetas pulidas y simétricas que celebran el buen vestir tradicional. La inversión definitiva en sutileza y distinción que nunca pasa de moda.

### TIFFANY & Co.

#### ESPECIFICACIONES



Oro / 18 Quilates



OBARRIO

PRECIO \$2,420



#### ESPECIFICACIONES



Oro / 14 Quilates



OBARRIO

PRECIO \$3,100

#### ESPECIFICACIONES



Oro / 14 Quilates



OBARRIO

PRECIO \$3,000



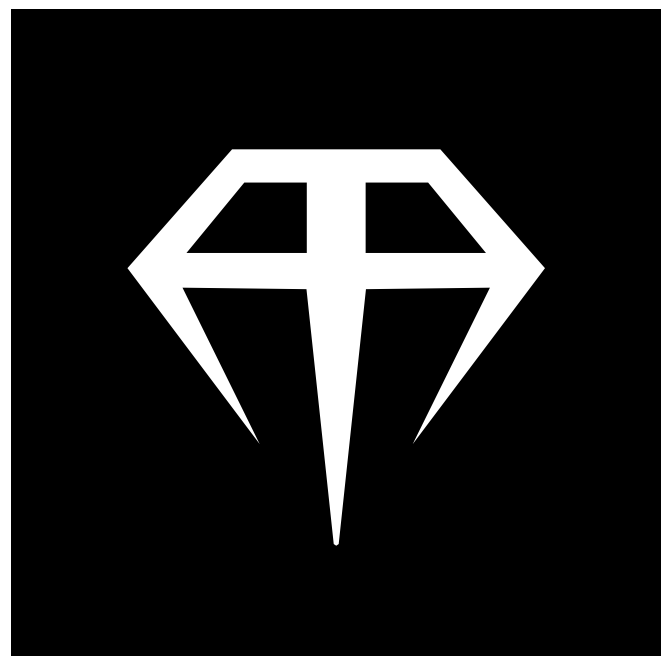

# Mancuernas

02

## Ingeniería de Precisión

Piezas que fusionan la micro-ingeniería con la alta joyería. Un homenaje al diseño estructural para quienes ven el detalle técnico como una forma de arte.



**BREITLING**  
1884

### ESPECIFICACIONES



Acero



OBARRIO

PRECIO



\$120

### ESPECIFICACIONES



Oro Rosa / 18 Quilates



OBARRIO

PRECIO



\$3,000



*Cartier*

### ESPECIFICACIONES



Acero



OBARRIO

PRECIO



\$500



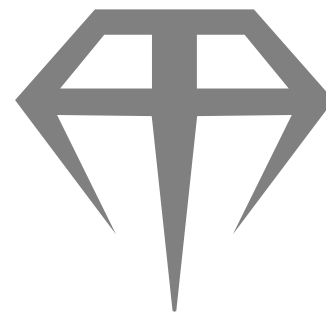

Aquí comienza su próxima gran elección.



## Boutique

OBARRIO

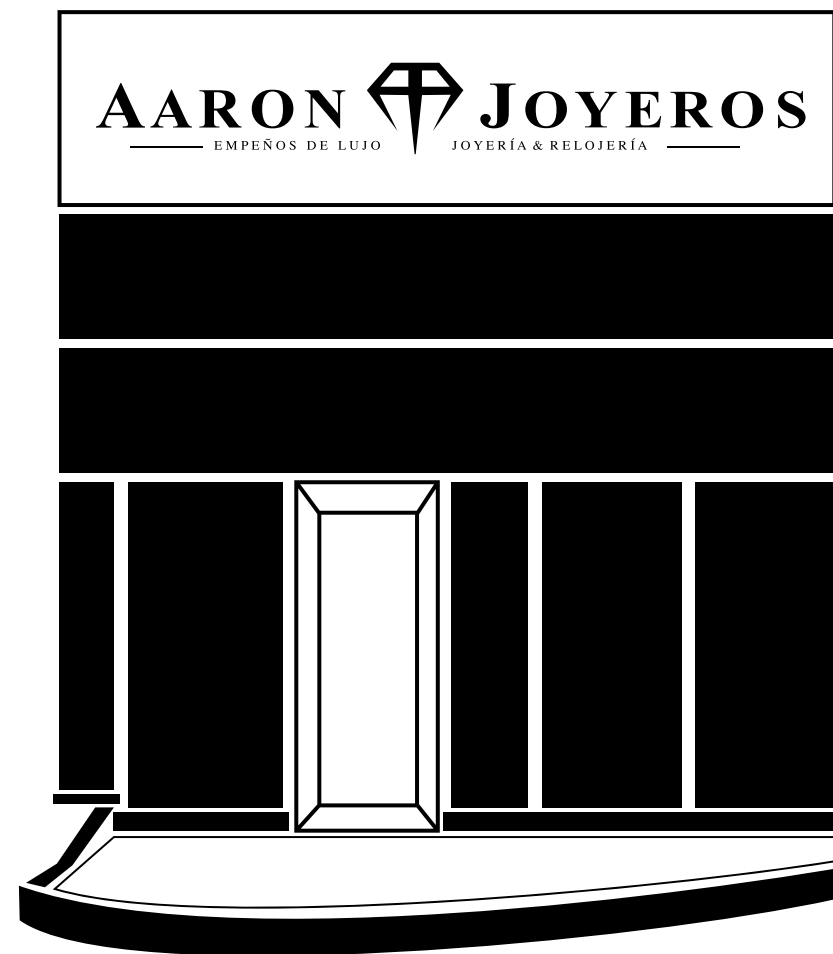

## Boutique

COSTA DEL ESTE