



CATÁLOGO

INTERACTIVO



Bienvenido a una experiencia de lujo y precisión

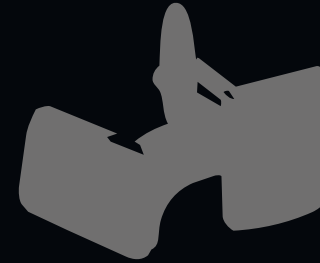

Haz **clic** en cada ícono de categoría para descubrir piezas seleccionadas con los más altos estándares de calidad, autenticidad y distinción. Cada sección te permitirá navegar fácilmente entre detalles, especificaciones y opciones disponibles.

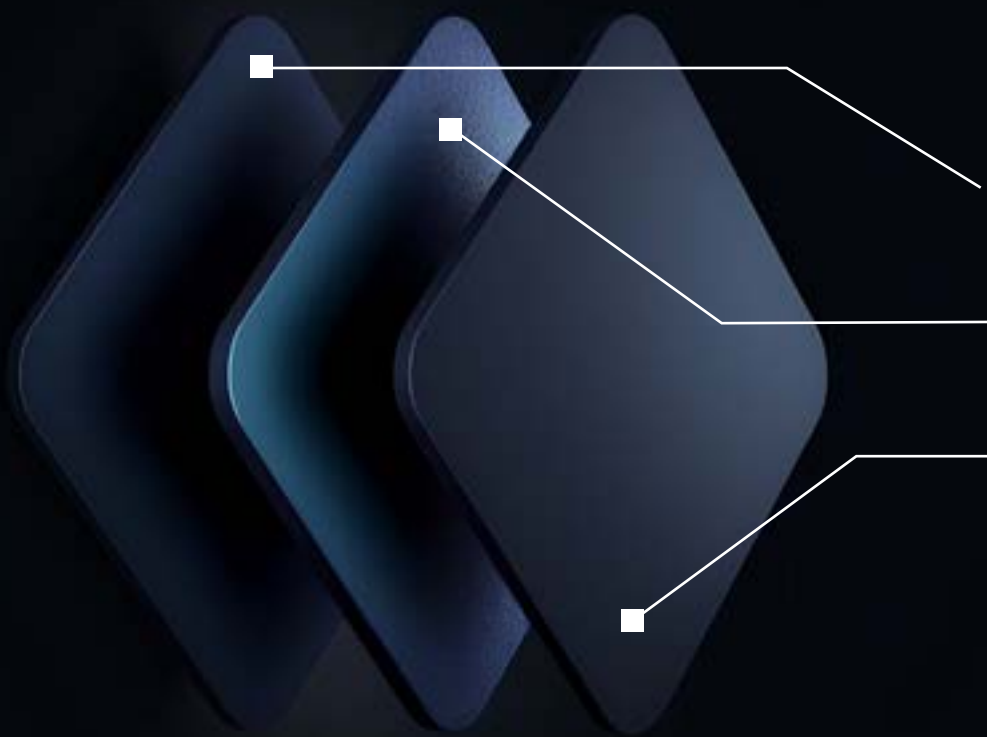

Exclusividad
Excelencia
Legado

AP
AUDEMARS PIGUET
Le maître de l'horlogerie depuis 1875

Chopard
GENÈVE

HAMILTON

CHARRIOL
GENÈVE

Alain Silberstein®

CONCORD

HARRY WINSTON

PIAGET

AZIMUT

CORUM

HUBLOT

RAYMOND WEIL
GENÈVE

BALL

DEVON

IWC
SCHAFFHAUSEN

REVUE THOMMEN
Since 1853

BAUME & MERCIER
MAISON D'HORLOGERIE GENÈVE 1830

EBEL

JACOB & Co.

ROGER DUBUIS

Bell & Ross

EBERHARD & Co

JAEGER-LECOULTRE

ROLEX

BERTOLUCCI

TAG Heuer
SWISS AVANT-GARDE SINCE 1860

BLANCPAIN

ÍNDICE
INTERACTIVO

TIFFANY & Co.

BOUCHERON
PARIS

TISSOT

EDOX

LONGINES

TUDOR

Breguet
Depuis 1775

FENDI

MAURICE LACROIX
Manufacture Horlogère Suisse

U-BOAT

BREITLING
1884

FREDERIQUE CONSTANT
GENÈVE

MONT BLANC

ULYSSE NARDIN
SINCE 1846 LE LOGLE - SUISSE

BVLGARI

GIRARD-PERREGAUX

OMEGA

VACHERON CONSTANTIN
GENÈVE

Cartier

GRAHAM
LONDON

ORIS
HÖLSTEIN 1904

Van Cleef & Arpels

CHANEL

GUCCI

PANERAI

CHAUMET
PARIS

Vintage

AARON JOYEROS
JOYERIA & RELOJERIA

AP
AUDEMARS PIGUET
Le maître de l'horlogerie depuis 1875

Fundada en 1875 y reconocida por su independencia, innovación técnica y excelencia artesanal. Ha destacado por el desarrollo de complicaciones de alto nivel y por revolucionar el diseño relojero con piezas icónicas como el Royal Oak.

Su enfoque combina tradición, ingeniería avanzada y una estética audaz, representando exclusividad y vanguardia en la alta relojería.



AP
AUDEMARS PIGUET
Le maître de l'horlogerie depuis 1875



ROYAL OAK

VOLCANO

\$20,000

-  ACERO
-  42 MM
-  AUTOMÁTICO





AARON  JOYEROS

26170ST. 00.D101CR.01
REFERENCIA

AP
AUDEMARS PIGUET
Le maître de l'horlogerie depuis 1875

ROYAL OAK



-  ORO ROSA
-  44 MM
-  AUTOMÁTICO

\$40,000



OBARRIO



CAJA





PAPELES

26401RO.00.A
 REFERENCIA

ROYAL OAK

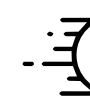

-  ORO ROSA
-  44 MM
-  AUTOMÁTICO

\$42,000



OBARRIO



CAJA





PAPELES

26401RO.00.A
 REFERENCIA

VINTAGE



-  ACERO
-  42 MM
-  AUTOMÁTICO

\$24,000





OBARRIO

VINTAGE
 REFERENCIA

ROYAL OAK



-  ORO / DIAMANTES
-  29 X 38 MM
-  AUTOMÁTICO

\$24,000



OBARRIO

6005BA
 REFERENCIA

VINTAGE



-  ORO AMARILLO
-  30.5 MM
-  QUARTZ

\$15,000



OBARRIO

0000
 REFERENCIA

Alain Silberstein[®]

Fundada en 1875, Audemars Piguet es reconocida por su independencia, innovación técnica y excelencia artesanal. La manufactura ha destacado por el desarrollo de complicaciones de alto nivel y por revolucionar el diseño relojero con piezas icónicas como el Royal Oak.

Su enfoque combina tradición, ingeniería avanzada y una estética audaz, representando exclusividad, vanguardia y prestigio dentro de la alta relojería.

AARON  **JOYEROS**

— JOYERIA & RELOJERIA —

Alain Silberstein®



KRONO Bauhaus

\$14,000



OBARRIO

AARON JOYEROS
— JOYERIA & RELOJERIA —

The logo for Azimuth, featuring a stylized white roof-like shape above the word "AZIMUT" in a bold, white, sans-serif font.

^ Z I M U T

Azimuth es una marca de relojería independiente reconocida por sus diseños futuristas, creatividad mecánica y enfoque poco convencional dentro de la alta relojería contemporánea. Sus relojes destacan por incorporar complicaciones originales, innovadoras formas de indicar el tiempo y una estética audaz inspirada en la ingeniería, la ciencia ficción y el automovilismo. Cada pieza refleja exclusividad, carácter y una visión única de la relojería, convirtiéndose en una opción ideal para coleccionistas que buscan originalidad y diferenciación.

AARON  **JOYEROS**
— JOYERIA & RELOJERIA —

GRAN TURISMO

BLACK PVD



 ACERO

 50 MM

 AUTOMÁTICO

\$3,000



OBARRIO



AZ.GT.BLPVD
REFERENCIA

BALL

Ball Watch Company es una marca suiza reconocida por su precisión, resistencia y herencia ligada a la relojería ferroviaria estadounidense. La firma se ha destacado por desarrollar relojes de alto rendimiento y por incorporar innovadores microtubos de gas que garantizan una excepcional visibilidad en la oscuridad. Su enfoque combina fiabilidad, ingeniería avanzada y robustez, representando precisión, durabilidad y excelencia técnica dentro de la relojería contemporánea.

AARON  JOYEROS

— JOYERIA & RELOJERIA —

BALL

 Índice



NM9026C-S44C-TQR
REFERENCIA

ENGINEER III MARVELIGHT

 ACERO

 43 MM

 AUTOMÁTICO

\$2,000



OBARRIO

AARON  JOYEROS

BALL

CAPELAND CHRONOGRAPH



ACERO

43 MM

AUTOMÁTICO

\$1,500



OBARRIO



CAJA

CM1030D

REFERENCIA

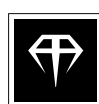



BAUME & MERCIER
MAISON D'HORLOGERIE GENEVE 1830

Baume & Mercier es una distinguida casa suiza reconocida por su elegancia equilibrada, calidad artesanal y enfoque accesible dentro del lujo. La firma se ha destacado por crear colecciones icónicas como Classima y Clifton, caracterizadas por su diseño refinado, precisión y versatilidad.

Su enfoque combina tradición relojera, sobriedad estética y funcionalidad, representando armonía, fiabilidad y elegancia atemporal dentro de la relojería suiza.

AARON  **JOYEROS**

— JOYERIA & RELOJERIA —

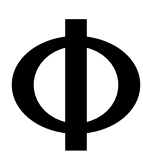

BAUME & MERCIER

MAISON D'HORLOGERIE GENEVE 1830

CHRONOGRAPH



- ACERO
- 44 MM
- AUTOMÁTICO

\$2,500



OBARRIO

10066

REFERENCIA

RIVIERA



- ACERO
- 38 MM
- QUARTZ

\$1,500



OBARRIO



CAJA



PAPELES

26310R.00

REFERENCIA

RIVIERA



- ACERO
- 43 MM
- AUTOMÁTICO

\$1,800



OBARRIO

65541

REFERENCIA

CLASSIMA



- ORO
- 24 MM
- AUTOMÁTICO

\$1,800



OBARRIO

MV045088

REFERENCIA

RIVIERA



- ACERO
- 43 MM
- AUTOMÁTICO

\$1,500



OBARRIO

65541

REFERENCIA

VINTAGE



- ACERO / DIAMANTES
- 27 MM
- QUARTZ

\$1,800



OBARRIO

65347

REFERENCIA

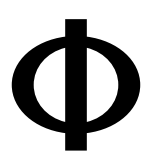

BAUME & MERCIER

MAISON D'HORLOGERIE GENEVE 1830

HAMPTON SPIRIT

"DIAL MADRE PERLA"

- ACERO
- 30 X 31 MM
- QUARTZ

\$1,000



MOA08450
REFERENCIA



COSTA DEL ESTE

CAJA

PAPELES

TANK

- ACERO
- 22 X 33 MM
- AUTOMÁTICO

\$2,500



97256
REFERENCIA



OBARRIO

HAMPTON CHRONOGRAPH

- ACERO
- 29 X 44 MM
- QUARTZ

\$1,000

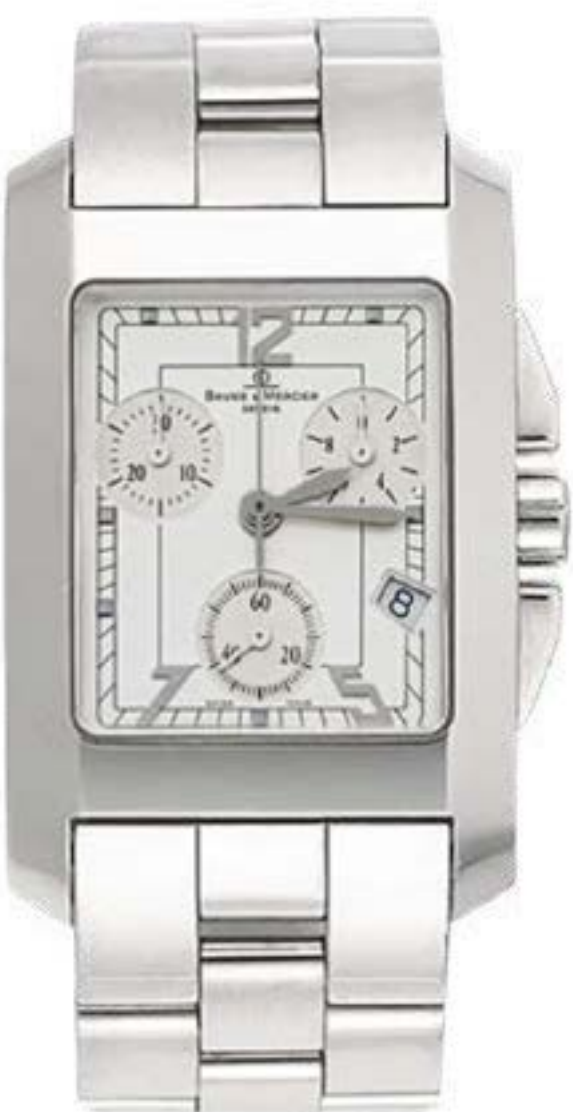

65341

REFERENCIA



OBARRIO

CATWALK

- ACERO / DIAMANTES
- 21 MM
- AUTOMÁTICO

\$650



MV045219

REFERENCIA



OBARRIO

HAMPTON

- ACERO
- 32 MM
- AUTOMÁTICO

\$950



65697

REFERENCIA



OBARRIO

CLIFTON GMT

- ACERO
- 43 MM
- AUTOMÁTICO

\$1,500



MOA10112

REFERENCIA



OBARRIO

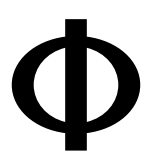

BAUME & MERCIER

MAISON D'HORLOGERIE GENEVE 1830

RECTANGLE

- ORO
- 39 MM
- AUTOMÁTICO

\$7,000



OBARRIO

8600
REFERENCIA

CLASSIMA EXECUTIVE

- ORO
- 39 MM
- AUTOMÁTICO

\$7,000



OBARRIO

65627
REFERENCIA

HAMPTON CRONÓGRAFO

- ACERO
- 34 X 29 MM
- AUTOMÁTICO

\$700



OBARRIO

65341
REFERENCIA

HAMPTON

- ACERO
- 42 X 39 MM
- AUTOMÁTICO

\$575



OBARRIO

65402
REFERENCIA

RECTANGLE

- "MADRE PERLA"**
- ACERO / ORO
- 22 X 33 MM
- AUTOMÁTICO

\$800



OBARRIO



CAJA



PAPELES

8600
REFERENCIA

CAPELAND

- ACERO
- 40 MM
- AUTOMÁTICO

\$950



OBARRIO



CAJA



PAPELES

MOA08123
REFERENCIA

Bell  Ross

Blancpain es una de las manufacturas más emblemáticas de la alta relojería, reconocida por su profunda tradición, innovación mecánica y excelencia artesanal. La firma se ha destacado por el desarrollo de complicaciones de alto nivel y por la creación de modelos icónicos como el Fifty Fathoms, considerado un referente en los relojes de buceo. Su enfoque combina herencia, precisión y elegancia atemporal, representando exclusividad, sofisticación y excelencia dentro de la alta relojería suiza.

AARON  JOYEROS

— JOYERIA & RELOJERIA —

PIHANTTOM

Bell & Ross

índice



OBARRIO



ACERO



42 MM



AUTOMÁTICO

\$2,400



BR0392-BL-CE
REFERENCIA



AARON  JOYEROS

CHRONOGRAPH



-  ACERO
-  44 MM
-  AUTOMÁTICO

\$3,200





OBARRIO

BR02-94-S
REFERENCIA



AVIATION



-  ACERO
-  46 MM
-  AUTOMÁTICO

\$3,300



OBARRIO

BR01-92-SHE
REFERENCIA





B
BERTOLUCCI

Bertolucci es una distinguida casa suiza de relojería reconocida por su elegancia, creatividad y marcada inspiración en el estilo mediterráneo. La firma se ha destacado por desarrollar relojes que combinan diseño sofisticado, materiales de alta calidad y una atención excepcional al detalle, reflejando una estética refinada y contemporánea. Su enfoque une artesanía, innovación y exclusividad, representando lujo, feminidad y distinción dentro del universo de la relojería suiza.

BERTOLUCCI PULCHRA



 ACERO / ORO

 40 MM

 AUTOMÁTICO

\$1,500



OBARRIO

674 8055 49

REFERENCIA



JB
1735
BLANCPAIN

Blancpain es una de las manufacturas más emblemáticas de la alta relojería, reconocida por su profunda tradición, innovación mecánica y excelencia artesanal. La firma se ha destacado por el desarrollo de complicaciones de alto nivel y por la creación de modelos icónicos como el Fifty Fathoms, considerado un referente en los relojes de buceo. Su enfoque combina herencia, precisión y elegancia atemporal, representando exclusividad, sofisticación y excelencia dentro de la alta relojería suiza.

JB
1735
BLANCPAIN

VILLEBERT



4063-1560-55
REFERENCIA

 ORO / DIAMANTES

 40 MM

 AUTOMÁTICO

\$12,500



OBARRIO

AARON  JOYEROS

GMT
FIFTY BALLONS



 ACERO

 40 MM

 AUTOMÁTICO

\$7,500



OBARRIO



CAJA



PAPELES

2250.1130.71

REFERENCIA







BOUCHERON
PARIS

Boucheron es una histórica casa parisina reconocida por su excelencia en alta joyería, creatividad artística y refinamiento estético. La firma se ha destacado por crear piezas excepcionales que combinan innovación, elegancia y un diseño distintivo, trasladando su savoir-faire joyero al universo de la relojería. Su enfoque une tradición, artesanía y expresión creativa, representando sofisticación, exclusividad y excelencia dentro del mundo del lujo.

REFLET
DIAMANTE

-  ACERO
-  18 X 29 MM
-  QUARTZ

\$1,200



OBARRIO



20 30 53

REFERENCIA

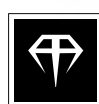



Breguet es una de las manufacturas más influyentes en la historia de la relojería, reconocida por su innovación, elegancia y extraordinario legado técnico. La firma se ha destacado por desarrollar importantes avances relojeros y por crear elementos icónicos como las agujas Breguet y las esferas guilloché, símbolos de refinamiento y distinción. Su enfoque combina tradición, precisión y excelencia artesanal, representando sofisticación, herencia y una profunda contribución al desarrollo de la alta relojería.



 ORO ROSA / CUERO

 39 MM

 AUTOMÁTICO

\$18,600

3820BA

REFERENCIA

AERONAVALE





BREITLING
1884

Breitling es una reconocida casa suiza de relojería, distinguida por su precisión, innovación y estrecha relación con el mundo de la aviación. La firma se ha destacado por el desarrollo de cronógrafos profesionales y por la creación de modelos icónicos como el Navitimer, considerado una referencia entre los relojes para pilotos. Su enfoque combina rendimiento, funcionalidad y diseño robusto, representando espíritu técnico, fiabilidad y excelencia dentro de la relojería deportiva.

AARON  **JOYEROS**

— JOYERIA & RELOJERIA —



BREITLING

1884

AVENGER



- ACERO
- 44 MM
- AUTOMÁTICO

\$3,500



OBARRIO

A32320

REFERENCIA

SUPER AVENGER



- ACERO
- 45 MM
- AUTOMÁTICO

\$3,500



OBARRIO

A73321

REFERENCIA

SUPER AVENGER



- ACERO
- 44 MM
- AUTOMÁTICO

\$4,000

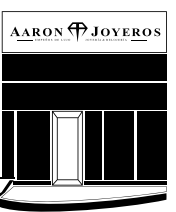

COSTA DEL ESTE

A13341

REFERENCIA

CHRONOMAT EVOLUTION



- ACERO / ORO
- 44 MM
- AUTOMÁTICO

\$6,800



OBARRIO

CB0110

REFERENCIA

ENDURANCE PRO



- CARBONO
- 44 MM
- QUARTZ

\$2,600



OBARRIO



CAJA



PAPELES

X82310A51B1S1

REFERENCIA

CHRONO COCKPIT



- ACERO / ORO
- 39 MM
- AUTOMÁTICO

\$3,000



OBARRIO

B13358

REFERENCIA



BREITLING

1884

COCKPIT B50 NIGHT MISSION



VB501022.BD41
REFERENCIA

- TITANIO
- 46 MM
- QUARTZ

\$4,800



OBARRIO

CHRONOMAT



AB0412
REFERENCIA

- ACERO
- 47 MM
- AUTOMÁTICO

\$4,200



OBARRIO

COCKPIT

"NUEVO A ESTRENAR"



VB5010
REFERENCIA

- ACERO
- 45 MM
- QUARTZ

\$4,800



OBARRIO



CAJA



PAPELES

AVENGER



E13360
REFERENCIA

- TITANIO
- 44 MM
- AUTOMÁTICO

\$3,000



OBARRIO

EXOSPACE



VB5010
REFERENCIA

- TITANIO
- 46 MM
- QUARTZ

\$4,500



OBARRIO

SUPER AVENGER



E13370
REFERENCIA

- ACERO
- 44 MM
- AUTOMÁTICO

\$3,800



OBARRIO



BREITLING

1884

NAVITIMER B03 CRONOGRAPH

RATRAPANTE 45

- ACERO
- 45 MM
- AUTOMÁTICO

\$7,800



OBARRIO



CAJA



PAPELES

AB03102A1F1A1
REFERENCIA

NAVITIMER CRONOGRAPH

- ACERO
- 45 MM
- AUTOMÁTICO

\$7,000



OBARRIO



CAJA



PAPELES

AB031021/Q615
REFERENCIA

CHRONOMAT 44 RAVEN

- ACERO
- 44 MM
- AUTOMÁTICO

\$4,800

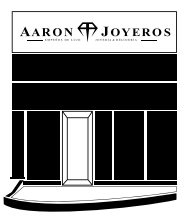

COSTA DEL ESTE

MB0111C2
REFERENCIA

AVENGER SEAWOLF

- ACERO
- 45 MM
- AUTOMÁTICO

\$2,600



OBARRIO

A17330
REFERENCIA

STARLINER

"MADRE PERLA"

- ACERO
- 30 MM
- AUTOMÁTICO

\$2,800



OBARRIO

A71340
REFERENCIA

NAVITIMER

- ACERO
- 38 MM
- AUTOMÁTICO

\$3,200

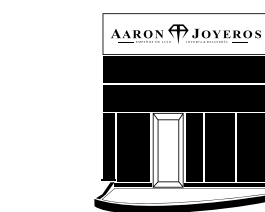

COSTA DEL ESTE

A17325211C1P3
REFERENCIA





BREITLING
1884

 **índice**

COLT GMT



-  ACERO
-  40.5 MM
-  AUTOMÁTICO

\$2,200





OBARRIO

A3235011

REFERENCIA

GALACTIC 36 SLEEK



-  ACERO
-  36 MM
-  AUTOMÁTICO

\$2,300





COSTA DEL ESTE

W74330

REFERENCIA

BENTLEY SUPER SPORTS



-  TITANIO
-  49 MM
-  AUTOMÁTICO

\$6,000



OBARRIO

E273622/BC63

REFERENCIA

COLT CRONOGRAPH



-  ACERO
-  41 MM
-  QUARTZ

\$2,000





OBARRIO

A73380

REFERENCIA

LADY J



-  ACERO
-  31 MM
-  AUTOMÁTICO

\$2,500





OBARRIO

D52065

REFERENCIA

AVENGER



-  ACERO
-  43 MM
-  AUTOMÁTICO

\$3,500



OBARRIO



CAJA



PAPELES

A17318

REFERENCIA



BREITLING

1884

AEROSPACE



- ORO
- 40 MM
- QUARTZ

\$7,000



OBARRIO

K65062

REFERENCIA

SUPEROCEAN CHRONOGRAPH 44



- ACERO
- 44 MM
- AUTOMÁTICO

\$4,800



OBARRIO



CAJA



PAPELES

M133132A1C1W1

REFERENCIA

SUPEROCEAN



- ACERO
- 44 MM
- AUTOMÁTICO

\$5,500



OBARRIO



CAJA

C13341

REFERENCIA

SUPEROCEAN



- ACERO
- 46 MM
- AUTOMÁTICO

\$5,000



OBARRIO



CAJA



PAPELES

U17320

REFERENCIA

SUPEROCEAN



- ACERO
- 41 MM
- AUTOMÁTICO

\$2,800



OBARRIO

A32380

REFERENCIA

COLT AUTO



- ACERO
- 41 MM
- AUTOMÁTICO

\$2,000



OBARRIO

A17380

REFERENCIA

BVLGARI

Bulgari es una destacada casa de lujo reconocida por su creatividad, innovación y capacidad para reinterpretar la relojería con una visión contemporánea. La firma se ha distinguido por la creación de modelos icónicos como el Octo, que combinan excelencia mecánica suiza con una marcada identidad de diseño italiano. Su enfoque une sofisticación, carácter arquitectónico y vanguardia estética, representando exclusividad, modernidad y excelencia dentro de la alta relojería.

AARON  **JOYEROS**

— JOYERIA & RELOJERIA —

DIAGNÓSTICO

BVLGARI



42 SC CH

REFERENCIA



CERÁMICA



42 MM



AUTOMÁTICO

\$7,000





OBARRIO



AARON  JOYEROS

DIAGONO GMT

-  ORO ROSA
-  40 MM
-  AUTOMÁTICO

\$14,500





OBARRIO



DGP40C6GLDGMT
REFERENCIA

DIAGONO GMT

-  ORO ROSA
-  40 MM
-  AUTOMÁTICO

\$14,500





OBARRIO



DGP40C6GLDGMT
REFERENCIA

OCTO FINISSIMO

-  ACERO
-  40 MM
-  AUTOMÁTICO

\$12,500



OBARRIO

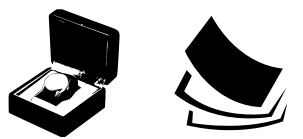



CAJA PAPELES



BG040C
REFERENCIA

OCTO FINISSIMO

-  ORO ROSA
-  40 MM
-  AUTOMÁTICO

\$32,600





OBARRIO



104190
REFERENCIA

RETTANGOLO

-  ACERO
-  29 MM
-  QUARTZ

\$1,500





OBARRIO



RTC 49 S
REFERENCIA

DIAGONO GMT

-  ACERO
-  42 MM
-  AUTOMÁTICO

\$4,500





OBARRIO



DP42SGMT
REFERENCIA

DANIEL ROTH



-  ACERO
-  47 MM
-  AUTOMÁTICO

\$7,000





OBARRIO

BRE 56S CHS
REFERENCIA

MOP LADY

"MADRE PERLA"



-  ACERO
-  37 MM
-  AUTOMÁTICO

\$7,000



OBARRIO





PAPELES

BBL P37 SG
REFERENCIA

SOTIRIO



-  ORO ROSA
-  42 MM
-  AUTOMÁTICO

\$13,500





OBARRIO

101705
REFERENCIA

B.ZERO1



-  ACERO
-  35 MM
-  QUARTZ

\$1,800



OBARRIO

BZ35BHDSGL/2
REFERENCIA

SOLOTEMPO ST



-  ACERO
-  28.6 MM
-  QUARTZ

\$1,500





OBARRIO

ST 295
REFERENCIA

RETTANGOLO



-  ACERO
-  38.4MM
-  QUARTZ

\$1,800



OBARRIO

RT39S
REFERENCIA

BVLGARI

DIAGONO



-  ACERO
-  40 MM
-  AUTOMÁTICO

\$2,500





OBARRIO

DG 40 SV
REFERENCIA

DIAGONO



-  ACERO
-  38 MM
-  AUTOMÁTICO

\$3,500





OBARRIO

BB 38 SS CH
REFERENCIA

ASSIOMA



-  ACERO
-  48 MM
-  AUTOMÁTICO

\$4,000





OBARRIO

AA 48 S CH
REFERENCIA

BVLGARI LADY



-  ACERO
-  33 MM
-  AUTOMÁTICO

\$3,500



OBARRIO



CAJA

BBL 33WSLC4
REFERENCIA

BVLGARI



-  ACERO
-  23 MM
-  AUTOMÁTICO

\$1,000





OBARRIO

BB23SS
REFERENCIA

RETTANGOLO



-  ORO
-  25 X 45 MM
-  AUTOMÁTICO

\$7,850





OBARRIO

RT 45 G
REFERENCIA

DIAGONO



-  TITANIO
-  38 MM
-  AUTOMÁTICO

\$2,500





OBARRIO

TI 38 R
REFERENCIA



DIAGONO



-  ACERO
-  36 MM
-  AUTOMÁTICO

\$1,500



OBARRIO

LCV35S
REFERENCIA



Cartier

Cartier es una prestigiosa maison de lujo reconocida por su herencia histórica, excelencia artesanal y extraordinaria influencia en la alta relojería. La firma se ha destacado por crear relojes icónicos que combinan innovación técnica con una refinada sensibilidad estética, convirtiéndose en referentes de elegancia y distinción. Su enfoque une tradición, creatividad y diseño atemporal, representando sofisticación, exclusividad y un legado que continúa marcando la relojería contemporánea.

AARON  JOYEROS

— JOYERIA & RELOJERIA —

PANTHERE

SANTOS

TANK

ROADSTER

BALLON BLEU

PASHA

RONDÉ

CLÉ

CALIBRE

MUST

PANTHERE VENDOME

"18 K"

 ORO

 22 MM

 QUARTZ

\$9,650



COSTA DEL ESTE



001366

REFERENCIA

PANTHERE COUGAR

 ORO

 33 MM

 QUARTZ

\$18,650



OBARRIO



887904

REFERENCIA

PANTHERE

SANTOS

TANK

ROADSTER

BALLON BLEU

PASHA

RONDÉ

CLÉ

CALIBRE

MUST



OBARRIO



SANTOS GALBÉE



ACERO



29 X 29 MM



AUTOMÁTICO

\$6,000



CAJA



PAPELES



W20055D6
REFERENCIA

PANTHERE

SANTOS

TANK

ROADSTER

BALLON BLEU

PASHA

RONDÉ



CLÉ

CALIBRE

MUST

SANTOS



-  ORO
-  39.8 MM
-  AUTOMÁTICO

\$35,000



OBARRIO





CAJA

WGSA0029

REFERENCIA

SANTOS GALBEE



-  ACERO / ORO
-  29 MM
-  AUTOMÁTICO

\$6,000



OBARRIO

1172961

REFERENCIA

SANTOS GALBEE



-  ACERO
-  29 MM
-  QUARTZ

\$5,500



OBARRIO



CAJA





PAPELES

1564

REFERENCIA

SANTOS GALBEE



-  ACERO
-  29 MM
-  QUARTZ

\$5,200





OBARRIO

1564

REFERENCIA

SANTOS XL



-  ACERO
-  39.8 MM
-  AUTOMÁTICO

\$6,500





OBARRIO

4072

REFERENCIA

SANTOS RONDÉ



-  ACERO / ORO
-  33 MM
-  AUTOMÁTICO

\$5,000



OBARRIO



CAJA



PAPELES

1920

REFERENCIA

PANTHERE

SANTOS

TANK

ROADSTER

BALLON BLEU

PASHA

RONDÉ

CLÉ

CALIBRE

MUST

TANK SOLO XL



-  ACERO
-  31 MM
-  AUTOMÁTICO

\$4,500



OBARRIO



CAJA





PAPELES

3800

REFERENCIA

TANK ANGLAISE



-  ORO ROSA
-  47 X 35.2 MM
-  AUTOMÁTICO

\$35,520



OBARRIO



PAPELES

W531002

REFERENCIA

TANK AMERICANO



-  ORO BLANCO
-  41 MM
-  AUTOMÁTICO

\$15,000



OBARRIO





CAJA

1726

REFERENCIA

TANK



-  ORO
-  28 X 36 MM
-  AUTOMÁTICO

\$6,650



OBARRIO

1830

REFERENCIA

TANK FRANCAISE



-  ACERO / ORO
-  27 X 27 MM
-  AUTOMÁTICO

\$3,700



OBARRIO

2302

REFERENCIA

PANTHERE

SANTOS

TANK

ROADSTER

BALLON BLEU

PASHA



RONDÉ

CLÉ

CALIBRE

MUST

ROADSTER

-  ORO
-  38 X 43 MM
-  AUTOMÁTICO

\$20,650





OBARRIO



2619

REFERENCIA

ROADSTER

-  ORO
-  47.6 x 42.8 MM
-  AUTOMÁTICO

\$2,850





OBARRIO



2619

REFERENCIA

ROADSTER

-  ORO
-  44 X 37 MM
-  AUTOMÁTICO

\$14,500





OBARRIO



2524

REFERENCIA

ROADSTER TORTUE

-  ORO ROSA
-  42.5 X 34 MM
-  AUTOMÁTICO

\$30,000





OBARRIO



2666

REFERENCIA

ROADSTER

-  ORO
-  47.6 MM
-  AUTOMÁTICO

\$38,000





OBARRIO



2619

REFERENCIA

ROADSTER

-  ACERO
-  43 x 49 MM
-  AUTOMÁTICO

\$5,600



OBARRIO



2618

REFERENCIA

PANTHERE

SANTOS

TANK

ROADSTER

BALLON BLEU

PASHA

RONDÉ

CLÉ

CALIBRE

MUST

BALLON BLEU



- ACERO
- 44 MM
- AUTOMÁTICO

\$6,500



OBARRIO

3109

REFERENCIA

BALLON BLEU



- ACERO
- 42 MM
- AUTOMÁTICO

\$5,000



OBARRIO

3765

REFERENCIA

BALLON BLEU



- ORO BLANCO
- 36 MM
- AUTOMÁTICO

\$9,000



OBARRIO



CAJA

3004

REFERENCIA

BALLON BLEU

"BISEL AFTERMARKET"



- ACERO
- 40 MM
- AUTOMÁTICO

\$6,800



OBARRIO

3001

REFERENCIA

BALLON BLEU



- ORO ROSA
- 42 MM
- AUTOMÁTICO

\$13,800



OBARRIO

2999

REFERENCIA

BALLON BLEU



- ORO ROSA
- 44 MM
- AUTOMÁTICO

\$14,500



OBARRIO



PAPELES

3107

REFERENCIA

PANTHERE

SANTOS

TANK

ROADSTER

BALLON BLEU

PASHA

RONDÉ

CLÉ

CALIBRE

MUST

BALLON BLEU

 ACERO / ORO ROSA

 42 MM

 AUTOMÁTICO

\$9,000



OBARRIO



CAJA



PAPELES



3765

REFERENCIA

BALLON BLEU

 ORO

 42.1 MM

 AUTOMÁTICO

\$25,000



OBARRIO



1846-1

REFERENCIA

BALLON BLEU

 ACERO

 42 MM

 AUTOMÁTICO

\$5,500



OBARRIO



WSBB0049

REFERENCIA

BALLON BLEU

 ACERO

 40 MM

 AUTOMÁTICO

\$6,300

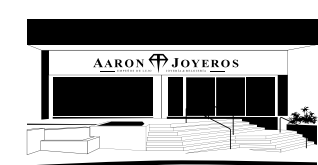

OBARRIO



CAJA



PAPELES



WSBB0061

REFERENCIA

PANTHERE

SANTOS

TANK

ROADSTER

BALLON BLEU

PASHA



RONDÉ

CLÉ

CALIBRE

MUST

PASHA

-  ACERO
-  38 MM
-  AUTOMÁTICO

\$4,500





OBARRIO



W31030H3

REFERENCIA

PASHA

-  ORO BLANCO
-  32 MM
-  AUTOMÁTICO

\$8,500



OBARRIO



2528

REFERENCIA

PASHA

-  ORO
-  38 MM
-  QUARTZ

\$10,500

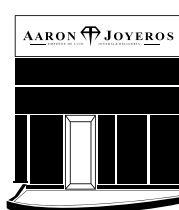



COSTA DEL ESTE



1987

REFERENCIA

PASHA

-  ACERO
-  33 MM
-  QUARTZ

\$3,200





OBARRIO



W3140001

REFERENCIA

PASHA

-  ORO
-  42 MM
-  AUTOMÁTICO

\$30,850





OBARRIO



2726

REFERENCIA

PASHA

-  ACERO
-  35 MM
-  AUTOMÁTICO

\$2,500



OBARRIO



1031

REFERENCIA

PANTHERE

SANTOS

TANK

ROADSTER

BALLON BLEU

PASHA

RONDÉ



CLÉ

CALIBRE

MUST

PASHA



-  ACERO
-  38 MM
-  AUTOMÁTICO

\$4,200





OBARRIO

2113

REFERENCIA

PASHA



-  ACERO
-  35 MM
-  AUTOMÁTICO

\$3,600



OBARRIO



CAJA



PAPELES

W31048M7

REFERENCIA



PANTHERE

SANTOS

TANK

ROADSTER

BALLON BLEU

PASHA

RONDÉ

CLÉ

CALIBRE

MUST

RONDE SOLO XL



 ACERO

 42 MM

 AUTOMÁTICO

\$3,500

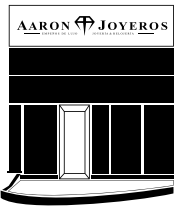

COSTA DEL ESTE

3802

REFERENCIA



PANTHERE

SANTOS

TANK

ROADSTER

BALLON BLEU

PASHA

RONDÉ



CLÉ

CALIBRE

MUST

CLÉ



-  ACERO
-  40 MM
-  AUTOMÁTICO

\$4,200



OBARRIO

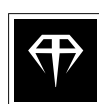

3850

REFERENCIA



CLÉ



-  ORO ROSA
-  40 MM
-  AUTOMÁTICO

\$25,000



OBARRIO

3847

REFERENCIA



PANTHERE

SANTOS

TANK

ROADSTER

BALLON BLEU

PASHA

RONDÉ

CLÉ

CALIBRE

MUST

CALIBRE

 ACERO

 42 MM

 AUTOMÁTICO

\$5,000



OBARRIO



3299

REFERENCIA

CALIBRE

 ACERO / ORO ROSA

 42 MM

 AUTOMÁTICO

\$7,000



OBARRIO



3398

REFERENCIA

CALIBRE

 ORO ROSA

 42 MM

 AUTOMÁTICO

\$37,000



OBARRIO



W7100018

REFERENCIA

CALIBRE

 ACERO / ORO ROSA

 42 MM

 AUTOMÁTICO

\$9,800



OBARRIO



W7100042

REFERENCIA

CALIBRE

 ACERO / ORO ROSA

 42 MM

 AUTOMÁTICO

\$6,000



OBARRIO



CAJA



W2CA0004

REFERENCIA

PANTHERE

SANTOS

TANK

ROADSTER

BALLON BLEU

PASHA

RONDÉ

CLÉ

CALIBRE

MUST

MUST

21

 PLATA CHAPADA EN ORO

 22 MM

 AUTOMÁTICO

\$2,500



OBARRIO

2415

REFERENCIA

MUST

21

 ACERO

 28 MM

 QUARTZ

\$1,500



OBARRIO

1340

REFERENCIA

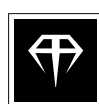

CHANEL

Chanel es una prestigiosa casa francesa reconocida por su creatividad, elegancia y visión innovadora dentro de la alta relojería. La firma se ha destacado por colecciones icónicas como J12 y Première, que combinan precisión suiza con una estética contemporánea y distintiva. Su enfoque une diseño vanguardista, materiales innovadores y refinamiento técnico, representando estilo, modernidad y una expresión única de lujo dentro del universo relojero.

AARON  **JOYEROS**

— JOYERIA & RELOJERIA —

CHANEL

CHANEL



H10132

REFERENCIA

CHANEL



CAJA



PAPELES

CHANEL



CERÁMICA



38 MM



AUTOMÁTICO

\$3,000





OBARRIO



CHANEL

J1



-  CERÁMICA
-  41 MM
-  AUTOMÁTICO

\$2,750



OBARRIO



CAJA

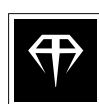

H2934

REFERENCIA



CHANEL



-  CERÁMICA
-  39 MM
-  AUTOMÁTICO

\$2,750



OBARRIO

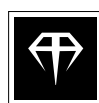

H2934

REFERENCIA



J12 NOIRE



-  CERÁMICA
-  38 MM
-  AUTOMÁTICO

\$2,600



OBARRIO

H5702

REFERENCIA



CHAUMET

PARIS

Chaumet es una histórica maison parisina reconocida por su elegancia, refinamiento y excepcional savoir-faire en el universo del lujo. La firma se ha destacado por crear piezas que integran la precisión relojera con el arte joyero, reflejando una estética delicada y una meticulosa atención al detalle. Su enfoque combina tradición, creatividad y excelencia artesanal, representando distinción, feminidad y sofisticación dentro de la alta relojería contemporánea.

AARON  JOYEROS

— JOYERIA & RELOJERIA —

KHESIS



 ACERO / NÁCAR / DIAMANTES

 21 MM

 QUARTZ

\$2,000



OBARRIO

40 38 44

REFERENCIA

KHESIS



 ACERO / DIAMANTES

 17.5 x 28 MM

 QUARTZ

\$1,800



OBARRIO

1.2330_PK

REFERENCIA

CLASS ONE CHRONO



 ACERO

 40 MM

 QUARTZ

\$1,800



OBARRIO

625B

REFERENCIA

STYLE



 ACERO / DIAMANTES

 19 x 23 MM

 QUARTZ

\$500



OBARRIO

35 34 13

REFERENCIA

MONTRE CHRONOGRAPHE



 ACERO

 40 MM

 AUTOMÁTICO

\$3,600



OBARRIO

0000

REFERENCIA

Chopard
GENÈVE

Chopard es una reconocida casa suiza distinguida por su excelencia artesanal, elegancia y estrecha vinculación entre la alta relojería y la joyería. La firma se ha destacado por crear colecciones icónicas que combinan innovación técnica, materiales de alta calidad y una meticulosa atención al detalle. Su enfoque une tradición, creatividad y sofisticación estética, representando refinamiento, exclusividad y excelencia dentro del universo de la relojería de lujo.

AARON  **JOYEROS**
— JOYERIA & RELOJERIA —

Chopard
GENÈVE



OBARRIO

GRAN TURISMO
RACE EDITION



-  ACERO
-  44 MM
-  AUTOMÁTICO

\$5,500

-  CAJA
-  PAPELES



168571-3004
REFERENCIA

AARON  JOYEROS



Chopard

GENÈVE

 índice

MILLE MIGLIA



-  ORO
-  44 MM
-  AUTOMÁTICO

\$19,000



OBARRIO



161276-5001

REFERENCIA

MILLE MIGLIA

"POWER CONTROL"



-  ACERO
-  43 MM
-  AUTOMÁTICO

\$4,800



OBARRIO



CAJA



PAPELES



168566-3001

REFERENCIA

GRAN TURISMO

XL



-  ACERO
-  44 MM
-  AUTOMÁTICO

\$4,500



COSTA DEL ESTE



8997

REFERENCIA

GRAND PRIX

DE MÓNACO



-  ACERO
-  42.5 MM
-  AUTOMÁTICO

\$3,800



COSTA DEL ESTE



168992-3031

REFERENCIA

GRAN TURISMO

XL



-  ACERO
-  44 MM
-  AUTOMÁTICO

\$3,500





OBARRIO

8997

REFERENCIA

SUPERFAST



-  ACERO
-  44 MM
-  AUTOMÁTICO

\$5,500



OBARRIO



8542

REFERENCIA

AARON  JOYEROS

MIGLIA



-  ORO
-  39 MM
-  AUTOMÁTICO

\$16,100



OBARRIO



CAJA



PAPELES

1274

REFERENCIA

HAPPY DIAMOND



-  ORO / DIAMANTES
-  25 MM
-  QUARTZ

\$4,800



OBARRIO





CAJA

20/5605

REFERENCIA

HAPPY BEACH



-  ORO ROSA
-  42 MM
-  QUARTZ

\$16,000





OBARRIO

283581-5011

REFERENCIA

IMPERIALE CHRONO



-  ACERO
-  38 MM
-  AUTOMÁTICO

\$2,500



OBARRIO





CAJA

8219

REFERENCIA

MILLE MIGLIA



-  ACERO
-  38 MM
-  AUTOMÁTICO

\$5,000



OBARRIO





CAJA

8588

REFERENCIA

IMPERIALE CHRONO



-  ACERO
-  37 MM
-  AUTOMÁTICO

\$3,000





OBARRIO

8219

REFERENCIA

IMPERIALE CHRONO



-  ACERO
-  40 MM
-  AUTOMÁTICO

\$5,500



OBARRIO





CAJA

8542

REFERENCIA

HAPPY SPORT



-  ACERO
-  38 MM
-  QUARTZ

\$4,800





OBARRIO

8347

REFERENCIA

LUNA D'ORO



-  ORO
-  34 MM
-  QUARTZ

\$3,875



OBARRIO

1086

REFERENCIA

HAPPY SPORT



-  ACERO / ORO ROSA
-  36 MM
-  QUARTZ

\$7,000



OBARRIO

8475

REFERENCIA

HAPPY SPORT



-  ACERO
-  42 MM
-  QUARTZ

\$4,000





OBARRIO

288525-3002

REFERENCIA

HAPPY SPORT



-  ACERO
-  38 MM
-  QUARTZ

\$2,000



OBARRIO

8347

REFERENCIA

Chopard

GENÈVE

 indice

HAPPY SPORT



-  ACERO
-  36 MM
-  QUARTZ

\$4,500



OBARRIO



CAJA





PAPELES

8475

REFERENCIA

HAPPY BEACH DIAMOND BLUE



-  ACERO
-  38 MM
-  QUARTZ

\$3,200





OBARRIO

8542

REFERENCIA

HAPPY SPORT



-  ACERO
-  42 MM
-  QUARTZ

\$4,500





OBARRIO

288499-3008

REFERENCIA

GRAN TURISMO XL



-  ACERO
-  44 MM
-  AUTOMÁTICO

\$3,500



OBARRIO



CAJA





PAPELES

8997

REFERENCIA

GRAN TURISMO



-  ACERO
-  44 MM
-  AUTOMÁTICO

\$3,800





OBARRIO

168997

REFERENCIA

MIGLIA



-  ACERO
-  40 MM
-  AUTOMÁTICO

\$2,600



OBARRIO



8955

REFERENCIA

AARON  JOYEROS

**MILLE MIGLIA
ALFA ROMEO**

"EDICIÓN LIMITADA"

-  ACERO
-  42 MM
-  AUTOMÁTICO

\$2,400





OBARRIO



8954

REFERENCIA

**MILLE MIGLIA
GRAN TURISMO**

-  ORO ROSA
-  45 MM
-  AUTOMÁTICO

\$22,050



OBARRIO



CAJA



PAPELES



161264

REFERENCIA





CONCORD

Concord es una casa relojera suiza reconocida por su espíritu innovador, diseño contemporáneo y enfoque distintivo dentro del segmento de lujo. La firma se ha destacado por desarrollar relojes de líneas modernas y propuestas estéticas audaces que desafían los códigos tradicionales de la relojería. Su enfoque combina creatividad, tecnología y una identidad visual marcada, representando modernidad, exclusividad y evolución dentro del diseño relojero contemporáneo.

MARINER



-  ACERO
-  38 MM
-  AUTOMÁTICO

\$950





OBARRIO

14H71891

REFERENCIA

CONCORD



-  ORO
-  22 MM
-  QUARTZ

\$9,500



OBARRIO

50-25-560

REFERENCIA



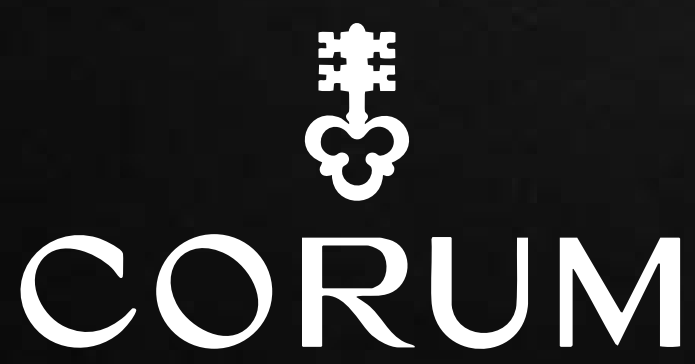

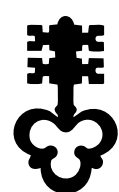

Corum es una prestigiosa manufactura suiza reconocida por su creatividad, innovación y enfoque poco convencional dentro de la alta relojería. La firma se ha destacado por la creación de modelos icónicos como el Admiral y el Golden Bridge, que reflejan una visión audaz del diseño y la mecánica relojera. Su enfoque combina excelencia técnica, originalidad estética y espíritu vanguardista, representando exclusividad, carácter e innovación dentro del universo de la relojería de lujo.



CORUM

ADMIRAL'S CUP



-  ORO ROSA
-  44 MM
-  AUTOMÁTICO

\$12,000



COSTA DEL ESTE

753 812

REFERENCIA

ADMIRAL'S CUP



"BISEL/CORONA ORO ROSA"

-  ACERO / ORO
-  48 MM
-  AUTOMÁTICO

\$5,500





OBARRIO

A690/04312

REFERENCIA

ADMIRAL'S CUP



-  ACERO
-  41 MM
-  AUTOMÁTICO

\$2,500





OBARRIO

82.833.20

REFERENCIA

ADMIRAL'S CUP



-  ORO ROSA
-  48 MM
-  AUTOMÁTICO

\$12,000



OBARRIO





CAJA

277.931.91/0371 AG32

REFERENCIA

VINTAGE



-  ORO
-  24 MM
-  QUARTZ

\$4,000



OBARRIO



PAPELES

0000

REFERENCIA



Corum es una prestigiosa manufactura suiza reconocida por su creatividad, innovación y enfoque poco convencional dentro de la alta relojería. La firma se ha destacado por la creación de modelos icónicos como el Admiral y el Golden Bridge, que reflejan una visión audaz del diseño y la mecánica relojera. Su enfoque combina excelencia técnica, originalidad estética y espíritu vanguardista, representando exclusividad, carácter e innovación dentro del universo de la relojería de lujo.



DEVON

TREAD 2 REDRUM



ACERO



44.2 x 41.7 MM



QUARTZ

\$6,000

M0064
REFERENCIA



CAJA

TREAD 2
REDRUM



ACERO

44.2 x 41.7 MM

QUARTZ

\$6,000



OBARRIO



CAJA

M0064

REFERENCIA



DUMOREAU

Dumoreau es una marca independiente de relojería reconocida por su enfoque contemporáneo, atención al detalle y compromiso con la excelencia mecánica. La firma se ha destacado por crear relojes de diseño refinado que combinan proporciones equilibradas, acabados de alta calidad y una marcada inspiración en la relojería clásica. Su enfoque une tradición, funcionalidad y elegancia discreta, representando autenticidad, exclusividad y artesanía dentro de la relojería independiente contemporánea.

AARON  **JOYEROS**

— JOYERIA & RELOJERIA —

DUMOREAU



 ACERO

 38.6 MM

 AUTOMÁTICO

\$700



OBARRIO

DM-01

REFERENCIA



AARON  JOYEROS



EBEL

Ebel es una reconocida casa suiza de relojería distinguida por su elegancia, refinamiento y enfoque en el diseño atemporal. La firma se ha destacado por crear relojes que combinan precisión técnica con líneas suaves y armoniosas, reflejando una estética sofisticada y versátil.

Su enfoque une tradición relojera, innovación y excelencia artesanal, representando estilo, calidad y distinción dentro del universo de la relojería de lujo.

SPORT WAVE



- ACERO / ORO
- 36 MM
- QUARTZ

\$1,200



OBARRIO

E6187631

REFERENCIA

SPORT WAVE



- ACERO
- 28 MM
- QUARTZ

\$750



OBARRIO



CAJA

E9955K41

REFERENCIA

SPORT WAVE



- ACERO
- 27.5 MM
- QUARTZ

\$900



OBARRIO

E9087622

REFERENCIA

CLASSIC WAVE



- ORO
- 26 MM
- QUARTZ

\$13,300

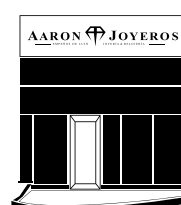

COSTA DEL ESTE

888901

REFERENCIA

DRESSWAVE



- ACERO / ORO
- 24 MM
- QUARTZ

\$700



OBARRIO

E6157912

REFERENCIA

DRESSWAVE



- ACERO
- 35 MM
- QUARTZ

\$750



OBARRIO



PAPELES

98501259

REFERENCIA

SPORT WAVE



ACERO

26 MM

QUARTZ

\$1,200



OBARRIO

12607794

REFERENCIA

E-TYPE



ACERO

27 MM

QUARTZ

\$1,000



OBARRIO

E9187C41

REFERENCIA

SPORT WAVE



ACERO

36 MM

QUARTZ

\$400



OBARRIO

E6120531

REFERENCIA



Eberhard & Co. es una histórica manufactura suiza reconocida por su tradición, precisión y experiencia en la creación de cronógrafos de alta calidad. La firma se ha destacado por desarrollar relojes técnicos y deportivos que combinan fiabilidad mecánica con una estética elegante y funcional. Su enfoque une innovación, herencia relojera y excelencia artesanal, representando rendimiento, sofisticación y autenticidad dentro de la relojería suiza contemporánea.



EBERHARD & CO

8 DÍAS



ORO



34 MM



CUERDA MANUAL

\$7,000



OBARRIO



CAJA

20017

REFERENCIA





Edox es una reconocida manufactura suiza distinguida por su precisión, resistencia y sólida trayectoria en la relojería deportiva. La firma se ha destacado por desarrollar relojes de buceo y alto rendimiento que combinan ingeniería robusta con un diseño funcional orientado a condiciones exigentes. Su enfoque une innovación, fiabilidad y excelencia técnica, representando durabilidad, exactitud y espíritu aventurero dentro de la relojería suiza contemporánea.

AARON  **JOYEROS**

— JOYERIA & RELOJERIA —

EDOX



 ACERO

 46 MM

 QUARTZ

\$900



OBARRIO



CAJA

10021 3 NIN
REFERENCIA





FENDI

Fendi es una prestigiosa casa italiana de lujo reconocida por su creatividad, elegancia y distintiva visión del diseño. La firma se ha destacado por trasladar su herencia de moda y marroquinería al universo de la relojería, creando piezas que combinan sofisticación estética, innovación y atención al detalle. Su enfoque une artesanía, estilo contemporáneo y refinamiento italiano, representando exclusividad, glamour y modernidad dentro de la relojería de lujo.

F FENDI

RUN AWAY



 ACERO

 36 MM

 QUARTZ

\$500



OBARRIO

FOW807A5UGF0QA1

REFERENCIA

RUN AWAY



 ACERO

 36 MM

 QUARTZ

\$340



OBARRIO

F136031573T01

REFERENCIA

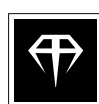



FREDERIQUE CONSTANT
GENEVE

Frederique Constant es una distinguida manufactura suiza reconocida por su elegancia, innovación y compromiso con la relojería mecánica de alta calidad. La firma se ha destacado por desarrollar movimientos propios y colecciones que combinan diseño clásico, precisión y acabados refinados, acercando la alta relojería a un público más amplio. Su enfoque une tradición, excelencia técnica y sofisticación, representando calidad, accesibilidad y autenticidad dentro de la relojería suiza contemporánea.

AARON  **JOYEROS**

— JOYERIA & RELOJERIA —

CLASSIC
MOONPHASE



ACERO

42 MM

AUTOMÁTICO

\$1,600



OBARRIO



CAJA



PAPELES

FC-335MC4P6

REFERENCIA

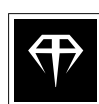

GP GIRARD-PERREGAUX

Girard-Perregaux es una de las manufacturas suizas más prestigiosas de la alta relojería, reconocida por su rica herencia histórica, excelencia mecánica y capacidad de innovación. La firma se ha destacado por desarrollar movimientos propios y por la creación de iconos como el legendario Tourbillon con Tres Puentes de Oro, símbolo de su maestría relojera. Su enfoque combina tradición, precisión y refinamiento estético, representando exclusividad, sofisticación y excelencia dentro de la alta relojería suiza.

AARON  JOYEROS

— JOYERIA & RELOJERIA —

VINTAGE
1945



25900-52-161-BAGA
REFERENCIA

-  ORO ROSA
-  23.5 MM
-  CUERDA MANUAL



\$4,500



OBARRIO

GYROMATIC



-  ORO
-  34 MM
-  AUTOMÁTICO

\$3,500



OBARRIO

352

REFERENCIA





GRAHAM
LONDON

Graham es una distintiva firma relojera suiza reconocida por su carácter técnico, diseño audaz y fuerte inspiración en la aviación. La marca se ha destacado por desarrollar cronógrafos innovadores con elementos únicos, como su emblemático gatillo lateral, que aporta funcionalidad y una identidad inconfundible. Su enfoque combina ingeniería, rendimiento y originalidad estética, representando innovación, personalidad y espíritu deportivo dentro de la relojería contemporánea.

AARON  **JOYEROS**
— JOYERIA & RELOJERIA —

CHRONOFIGHTER



-  ACERO
-  46 MM
-  AUTOMÁTICO

\$3,000



OBARRIO





CAJA

2CCAU.B02A.T13N
REFERENCIA

**CHRONOFIGHTER
OVERSIZE**



-  ACERO
-  47 MM
-  AUTOMÁTICO

\$3,000



OBARRIO



CAJA





PAPELES

20VDIVAZ.B02A.K10B
REFERENCIA

**CHRONOFIGHTER
OVERSIZE**



-  ACERO
-  47 MM
-  AUTOMÁTICO

\$3,800





OBARRIO

OR-20VBV-1
REFERENCIA

CHRONOFIGHTER



-  ACERO
-  43 MM
-  AUTOMÁTICO

\$3,500



OBARRIO

2CRBS.B02A.L81B
REFERENCIA



Gucci es una influyente casa italiana de lujo reconocida por su creatividad, innovación y fuerte identidad estética. La firma se ha destacado por trasladar su visión del diseño al universo de la relojería, creando piezas que combinan estilo contemporáneo, calidad y detalles distintivos. Su enfoque une moda, artesanía y expresión creativa, representando modernidad, exclusividad y una perspectiva única dentro de la relojería de lujo.

BLACK SNAKE



ACERO

45 MM

QUARTZ

\$1,000



OBARRIO

YA136218

REFERENCIA





HAMILTON

Hamilton es una histórica marca de relojería reconocida por combinar la precisión suiza con una sólida herencia estadounidense, destacándose por su innovación técnica, diseños versátiles y espíritu aventurero. La firma se ha consolidado en ámbitos como la aviación, el cine y el uso militar, creando relojes que equilibran funcionalidad, rendimiento y elegancia. Sus colecciones reflejan un estilo clásico con detalles contemporáneos, representando tradición, calidad y carácter dentro de la relojería moderna.

AARON  **JOYEROS**
— JOYERIA & RELOJERIA —

VENTURA
XXL BRIGHT DUNE

"EDICIÓN LIMITADA"

-  ACERO
-  52 MM
-  QUARTZ



\$1,700



OBARRIO



CAJA





PAPELES

H24614330

REFERENCIA

VENTURA

-  ACERO
-  46 MM
-  AUTOMÁTICO



\$1,000





OBARRIO

H24655331

REFERENCIA

VALIANT AUTO

-  ACERO
-  40 MM
-  AUTOMÁTICO



\$700



OBARRIO



CAJA





PAPELES

H395150

REFERENCIA

JAZZ MASTER

-  ACERO
-  42 MM
-  AUTOMÁTICO



\$850



OBARRIO





CAJA

H895450

REFERENCIA

KHAKI AVIATION

-  ACERO
-  44 MM
-  AUTOMÁTICO



\$700



OBARRIO

H77616533

REFERENCIA



HARRY WINSTON

Harry Winston es una prestigiosa maison de lujo reconocida por su excelencia en alta joyería y su refinado enfoque en la relojería de alta gama. La firma se ha distinguido por crear piezas excepcionales que combinan sofisticación, innovación y un meticuloso trabajo artesanal, integrando el brillo de las gemas con la precisión relojera. Su enfoque une elegancia, exclusividad y maestría técnica, representando lujo absoluto, distinción y un legado icónico dentro del universo de la relojería contemporánea.

AARON  **JOYEROS**

— JOYERIA & RELOJERIA —



HARRY WINSTON

**TOURBILLÓN
GLISSIERE**



 ORO ROSA

 48 MM

 AUTOMÁTICO

\$120,000



OBARRIO



CAJA



PAPELES

**350-MATRL
REFERENCIA**



PRECIO RETAIL

\$350,000

CON MANTENIMIENTO DE AGENCIA

HUBLLOT

Hublot es una prestigiosa manufactura suiza reconocida por su innovación, diseño contemporáneo y enfoque vanguardista dentro de la alta relojería. La firma se ha destacado por la creación del concepto "Art of Fusion", combinando materiales tradicionales y modernos como oro, cerámica y caucho en diseños audaces. Sus colecciones reflejan carácter deportivo, tecnología y estética disruptiva, representando modernidad, exclusividad y una visión innovadora dentro del universo relojero de lujo.



AARON  JOYEROS

— JOYERIA & RELOJERIA —

HUBLOT

KING POWER UEFA EURO 2012



-  ACERO
-  48 MM
-  AUTOMÁTICO

\$13,500



OBARRIO





CAJA

716.NM.1129.RX.EURO12
REFERENCIA

KING POWER



-  ORO ROSA
-  48 MM
-  AUTOMÁTICO

\$15,000





OBARRIO

01.OQ.0180.RX
REFERENCIA

BIG BANG



-  ACERO
-  44 MM
-  AUTOMÁTICO

\$7,500



OBARRIO

KING POWER ÚNICO



-  TITANIO / DIAMANTES
-  48 MM
-  AUTOMÁTICO

\$20,000



OBARRIO





PAPELES

701.NX.0170.RX.1740
REFERENCIA

BIG BANG FERRARI



-  TITANIO
-  45 MM
-  AUTOMÁTICO

\$15,000





OBARRIO

401.NQ.0123.VR
REFERENCIA

KING POWER SAINT BARTH



-  CERÁMICA
-  48 MM
-  AUTOMÁTICO

\$15,000





OBARRIO

HUB4200
REFERENCIA

HUBLOT

BIG BANG RED



-  CERÁMICA
-  44 MM
-  AUTOMÁTICO

\$9,500

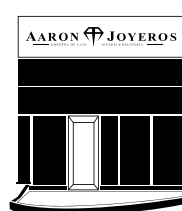



COSTA DEL ESTE

301.CI.1130.GR.ABR10
REFERENCIA

BIG BANG



-  CARBONO
-  45 MM
-  AUTOMÁTICO

\$14,000



OBARRIO



CAJA



PAPELES

411.YT.1110.NR.IT115
REFERENCIA

BIG BANG



-  TITANIO / DIAMANTES
-  45 MM
-  AUTOMÁTICO

\$12,500





OBARRIO

4j01.CX.0123.VR
REFERENCIA

BIG BANG



-  CERÁMICA
-  44 MM
-  AUTOMÁTICO

\$9,000



OBARRIO



CAJA



PAPELES

301.CT.130.RX
REFERENCIA

BIG BANG KING POWER F1



-  ORO ROSA
-  48 MM
-  AUTOMÁTICO

\$21,000



OBARRIO



CAJA



PAPELES

703.OM.1138.NR.FM010
REFERENCIA

BIG BANG BI-RETROGRADE

"KING ORO"

-  CERÁMICA / ORO ROSA
-  45 MM
-  AUTOMÁTICO

\$24,200



COSTA DEL ESTE



413.OM.1128.RX
REFERENCIA

HUBLOT

KING POWER F1 ABU DHABI

"LIMITED EDITION"

 FIBRA DE CARBÓN

 48 MM

 AUTOMÁTICO

\$10,000



OBARRIO



CAJA



719.QM.1729.NR.FAD11

REFERENCIA

BIG BANG CHRONOGRAPH

 ORO ROSA

 44 MM

 AUTOMÁTICO

\$17,500



OBARRIO



301.PM.1780.RX

REFERENCIA

BIG BANG JEANS

 ACERO

 44 MM

 AUTOMÁTICO

\$9,800



OBARRIO



301.SX.2710.NR.JEANS

REFERENCIA

BIG BANG

 ACERO

 44 MM

 AUTOMÁTICO

\$8,500



OBARRIO



301.CI.2770.NR

REFERENCIA

MDN GENEVE

 ORO

 36 MM

 QUARTZ

\$6,500



OBARRIO



CAJA



PAPELES



1512.100.3

REFERENCIA

MDN TEDDY BEAR

 ACERO

 26 MM

 QUARTZ

\$2,000



OBARRIO



CAJA



PAPELES



1392.999.3

REFERENCIA

HUBLOT

BIG BANG



 ORO ROSA / TITANIO

 45 MM

 AUTOMÁTICO

\$19,500



OBARRIO



CAJA

614.OX.1180.RX
REFERENCIA

BIG BANG



 ORO ROSA

 41 MM

 AUTOMÁTICO

\$18,000



OBARRIO

341.PT.5010.LR.1104
REFERENCIA

CLASSIC FUSION



 ACERO

 42 MM

 AUTOMÁTICO

\$6,000



OBARRIO



CAJA



PAPELES

542.NX.1270.RX
REFERENCIA

CLASSIC FUSION



 TITANIO

 45 MM

 AUTOMÁTICO

5,700



OBARRIO

511.NX.1170.LR
REFERENCIA

BIG BANG



 ACERO

 44 MM

 AUTOMÁTICO

\$7,500



OBARRIO

301SX.1170.RX
REFERENCIA

CLASSIC FUSION



 TITANIO

 42 MM

 AUTOMÁTICO

\$6,000





OBARRIO

542.NX.8970.RX
REFERENCIA

HUBLOT

BIG BANG BLACK DIAL



-  CERÁMICA
-  44 MM
-  AUTOMÁTICO

\$6,800





OBARRIO

301.CM.130.RX
REFERENCIA

SUPER B



-  ORO ROSA
-  42 MM
-  AUTOMÁTICO

\$20,000





OBARRIO

1920.8
REFERENCIA

BIG BANG KING POWER



-  ACERO
-  44 MM
-  AUTOMÁTICO

\$9,500



OBARRIO

701.CI.1123.GR
REFERENCIA

BIG BANG



-  ACERO
-  38 MM
-  QUARTZ

\$7,500



OBARRIO

361.SX.7170.LR.1204
REFERENCIA

BIG BANG KING POWER F1



-  FIBRA DE CARBONO
-  48 MM
-  AUTOMÁTICO

\$11,000



OBARRIO



CAJA



PAPELES

703.QM.1129.HR.FIL11
REFERENCIA



IWC

SCHAFFHAUSEN

IWC Schaffhausen es una prestigiosa manufactura suiza reconocida por su excelencia técnica, precisión y diseño funcional. La firma se ha destacado por desarrollar relojes de ingeniería avanzada y colecciones icónicas vinculadas a la aviación, la navegación y la alta relojería, combinando robustez con elegancia atemporal. Su enfoque une innovación, artesanía y rendimiento, representando sofisticación, fiabilidad y tradición dentro de la relojería suiza de lujo.

INGENIEUR



-  CERÁMICA
-  46 MM
-  AUTOMÁTICO

\$5,500





OBARRIO

IW322504
REFERENCIA

AQUATIMER



-  ACERO
-  46.6 MM
-  AUTOMÁTICO

\$4,200





OBARRIO

IW376709
REFERENCIA

AQUATIMER



-  ACERO
-  42 MM
-  AUTOMÁTICO

\$3,500



OBARRIO



CAJA





PAPELES

IW3719/33
REFERENCIA

PORTUGIESE YACHT CLUB

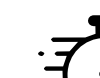

-  ACERO
-  44 MM
-  AUTOMÁTICO

\$7,800





OBARRIO

W390503
REFERENCIA

AQUATIMER

"EDICIÓN GALÁPAGOS"



-  ACERO
-  44 MM
-  AUTOMÁTICO

\$4,000





OBARRIO

W376705
REFERENCIA

AQUATIMER

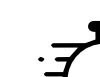

-  ORO ROSA
-  44 MM
-  AUTOMÁTICO

\$20,000



OBARRIO



CAJA



PAPELES

W3769-05
REFERENCIA



Jacob & Co. es una exclusiva firma de alta relojería reconocida por su creatividad, innovación y diseños extraordinariamente audaces. La marca se ha destacado por desarrollar complicaciones de gran complejidad y relojes de fuerte impacto visual, donde la ingeniería mecánica se fusiona con la alta joyería y una estética vanguardista. Su enfoque combina excelencia técnica, exclusividad y expresión artística, representando lujo, innovación y una visión disruptiva dentro del universo de la alta relojería.

FIVE TIME ZONE



 ACERO

 48 MM

 QUARTZ

\$2,500



OBARRIO

JCM-29

REFERENCIA





Jaeger-LeCoultre es una histórica manufactura suiza reconocida por su excelencia técnica, innovación y maestría en la creación de calibres propios. La firma se ha destacado por desarrollar numerosas complicaciones relojeras y por la creación de modelos icónicos como el Reverso, símbolo de elegancia e ingenio mecánico.

Su enfoque combina tradición, precisión y excelencia artesanal, representando sofisticación, innovación y una de las más altas expresiones de la relojería suiza.

AARON  **JOYEROS**

— JOYERIA & RELOJERIA —

MASTER CALENDAR



- ORO ROSA
- 39 MM
- AUTOMÁTICO

\$14,000



OBARRIO

176.2.12.S
REFERENCIA

RENDEZ-VOUS



- ACERO
- 34 MM
- AUTOMÁTICO

\$7,000



OBARRIO

344.8.37
REFERENCIA

LONGINES

Longines es una histórica casa suiza de relojería reconocida por su elegancia, precisión y rica tradición relojera. La firma se ha destacado por su estrecha vinculación con el mundo de la aviación, los deportes y el cronometraje profesional, desarrollando relojes que combinan rendimiento técnico con un diseño refinado. Su enfoque une herencia, innovación y sofisticación atemporal, representando fiabilidad, distinción y excelencia dentro de la relojería suiza.

AARON  JOYEROS

— JOYERIA & RELOJERIA —

CONQUEST



- ACERO
- 44.5 MM
- AUTOMÁTICO

\$2,000



OBARRIO

L3.6974

REFERENCIA

VINTAGE



- ORO
- 24 MM
- AUTOMÁTICO

\$9,400

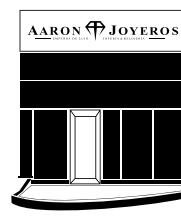

COSTA DEL ESTE



CAJA



PAPELES

26310R.00

REFERENCIA

LEGEND DIVER



- ACERO
- 42 MM
- AUTOMÁTICO

\$2,200



OBARRIO

L3.774.4.50.9

REFERENCIA

EVIDENZA



- ACERO
- 38.75 MM
- AUTOMÁTICO

\$1,500



OBARRIO

L2.642.4.51.6

REFERENCIA

SAINT-IMIER



- ORO
- 36.8 MM
- AUTOMÁTICO

\$5,600



OBARRIO

L.989.2

REFERENCIA

MASTER COLLECTION

"PULSO AFTERMARKET"



- ACERO
- 42 MM
- AUTOMÁTICO

\$1,600





OBARRIO

L26664783

REFERENCIA

SPIRIT



-  ACERO
-  37 MM
-  AUTOMÁTICO

\$2,100



OBARRIO



CAJA



PAPELES



L3.410.4.93.6

REFERENCIA



SPIRIT



-  ACERO
-  37 MM
-  AUTOMÁTICO

\$2,400



OBARRIO



CAJA



PAPELES



L3.410.4.93.6

REFERENCIA



HERITAGE AVIGATION BIG EYE



-  TITANIO
-  41 MM
-  AUTOMÁTICO

\$3,200



OBARRIO



CAJA



PAPELES

L2.816.1

REFERENCIA



MAURICE  LACROIX
Manufacture Horlogère Suisse



Maurice Lacroix es una reconocida manufactura suiza distinguida por su innovación, calidad y excelente relación entre tradición relojera y diseño contemporáneo. La firma se ha destacado por desarrollar movimientos propios y colecciones emblemáticas que combinan precisión mecánica, acabados refinados y una estética moderna. Su enfoque une creatividad, excelencia técnica y accesibilidad dentro del segmento de lujo, representando sofisticación, fiabilidad y carácter en la relojería suiza contemporánea.

AARON  JOYEROS
— JOYERIA & RELOJERIA —

MASTERPIECE
RETRÓGRADO



MP7218-PG101-130
REFERENCIA

-  ORO
-  46 MM
-  AUTOMÁTICO

\$19,000





OBARRIO

MASTERPIECE



OBARRIO

-  ORO
-  40 MM
-  AUTOMÁTICO

\$17,000

MP6388
REFERENCIA



**MONT
BLANC** 

Montblanc es una distinguida casa de lujo reconocida por su excelencia artesanal, elegancia y creciente protagonismo en la alta relojería. La firma se ha destacado por combinar la precisión suiza con un diseño refinado y contemporáneo, desarrollando colecciones que reflejan tradición, innovación y atención al detalle. Su enfoque une herencia, funcionalidad y sofisticación estética, representando calidad, exclusividad y una visión moderna dentro del universo de la relojería de lujo.

AARON  JOYEROS

— JOYERIA & RELOJERIA —

TIMEWALKER



- ACERO
- 43 MM
- AUTOMÁTICO

\$2,200



OBARRIO

7069

REFERENCIA

TIMEWALKER



- ACERO
- 42 MM
- AUTOMÁTICO

\$1,500



OBARRIO



CAJA

4810

REFERENCIA

TIMEWALKER



- ACERO
- 39 MM
- AUTOMÁTICO

\$1,800



OBARRIO



CAJA



PAPELES

7308

REFERENCIA

TIMEWALKER OROLOGIO



- ACERO
- 43 MM
- AUTOMÁTICO

\$1,600



OBARRIO

0969

REFERENCIA

TIMEWALKER



- ACERO
- 42 MM
- AUTOMÁTICO

\$1,200

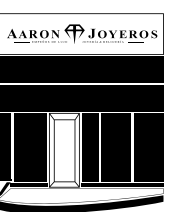

COSTA DEL ESTE

7070

REFERENCIA

TIMEWALKER GMT



- ACERO
- 42 MM
- AUTOMÁTICO

\$2,000



OBARRIO

7081

REFERENCIA

PRINCESS GRACE DE MÓNACO



- ACERO
- 34 MM
- QUARTZ

\$1,500



OBARRIO



CAJA

106884

REFERENCIA

MEINSTERSTUCK



- ACERO
- 41 MM
- AUTOMÁTICO

\$1,500



OBARRIO

7034

REFERENCIA

MONTBLANC



- ACERO
- 41 MM
- AUTOMÁTICO

\$3,500



OBARRIO

7383

REFERENCIA

MEINSTERSTUCK



- ACERO
- 43 MM
- AUTOMÁTICO

\$2,000



OBARRIO

7141

REFERENCIA

MONTBLANC

1858



- ACERO
- 42 MM
- AUTOMÁTICO

\$2,200



OBARRIO



CAJA



PAPELES

1958

REFERENCIA

STAR



- ACERO
- 42 MM
- AUTOMÁTICO

\$2,500



OBARRIO

10642

REFERENCIA



OMEGA es una prestigiosa manufactura suiza reconocida por su precisión, innovación y destacada trayectoria dentro de la alta relojería. La firma se ha distinguido por la creación de modelos icónicos como el Speedmaster y el Seamaster, además de su participación en la exploración espacial y el cronometraje deportivo de máximo nivel. Su enfoque combina excelencia técnica, diseño atemporal y espíritu pionero, representando rendimiento, fiabilidad y prestigio dentro del universo de la relojería de lujo.

SEAMASTER

SPEEDMASTER

CONSTELLATION

DE VILLE

SEAMASTER



- ORO
- 41 MM
- AUTOMÁTICO

\$33,300



OBARRIO

2134.80.00

REFERENCIA

**SEAMASTER
PLANET OCEAN**

"PANAMA CANAL"



- ACERO
- 45.5 MM
- AUTOMÁTICO

\$6,000



OBARRIO

232.30.46.21.01.005

REFERENCIA

SEAMASTER



- TITANIO
- 45.5 MM
- AUTOMÁTICO

\$8,000



OBARRIO



CAJA



PAPELES

215.90.46.51.99.001

REFERENCIA

**SEAMASTER
PLANET OCEAN**



- ACERO
- 43.5 MM
- AUTOMÁTICO

\$5,000



OBARRIO



CAJA



PAPELES

232.30.44.22.01.001

REFERENCIA

**SEAMASTER
PLANET OCEAN**



- CERÁMICA
- 45.5 MM
- AUTOMÁTICO

\$8,500



OBARRIO

215.92.22.01.004

REFERENCIA

**SEAMASTER
PLANET OCEAN**



- ACERO
- 43.5 MM
- AUTOMÁTICO

\$5,000



OBARRIO



CAJA



PAPELES

232.30.44.22.01.001

REFERENCIA

SEAMASTER

SPEEDMASTER

CONSTELLATION

DE VILLE

SEAMASTER

- ACERO
- 36 MM
- AUTOMÁTICO

\$2,500



OBARRIO

2551.80

REFERENCIA

SEAMASTER

- ACERO
- 36 MM
- QUARTZ

\$1,800



OBARRIO

2561.80.00

REFERENCIA

SEAMASTER

- ACERO
- 36 MM
- QUARTZ

\$2,000



OBARRIO

2561.80.00

REFERENCIA

SEAMASTER

- ACERO
- 41 MM
- AUTOMÁTICO

\$3,800



OBARRIO



CAJA



PAPELES

212.30.41.20.01.003

REFERENCIA

SEAMASTER

- ACERO
- 36 MM
- QUARTZ

\$2,000



OBARRIO

2561.80.00

REFERENCIA

SEAMASTER

- ACERO
- 41 MM
- QUARTZ

\$3,300



OBARRIO

212.30.41.61.01.001

REFERENCIA

SEAMASTER



SPEEDMASTER

CONSTELLATION

DE VILLE

SEAMASTER
AQUA TERRA



-  ACERO
-  43 MM
-  AUTOMÁTICO

\$4,500





COSTA DEL ESTE

231.10.44.50.02.001
REFERENCIA

SEAMASTER



-  ORO
-  34 MM
-  AUTOMÁTICO

\$3,500



OBARRIO





CAJA

166.0217
REFERENCIA

SEAMASTER
300



-  ACERO
-  45.5 MM
-  AUTOMÁTICO

\$5,800





OBARRIO

234.30.41.21.03.001
REFERENCIA

SEAMASTER
AQUA TERRA



-  ACERO
-  43 MM
-  AUTOMÁTICO

\$8,000



OBARRIO



CAJA





PAPELES

0.220.12.43.22.03.001
REFERENCIA

SEAMASTER



-  ACERO
-  38 MM
-  AUTOMÁTICO

\$4,000





OBARRIO

145.029
REFERENCIA

SEAMASTER



-  ACERO
-  38.5 MM
-  AUTOMÁTICO

\$4,500



COSTA DEL ESTE



CAJA



PAPELES

231.92.39.21.04.001
REFERENCIA

SEAMASTER

SPEEDMASTER

CONSTELLATION

DE VILLE

SPEEDMASTER MOONPHASE



304.33.44.52.03.001

REFERENCIA

- ACERO
- 44.2 MM
- AUTOMÁTICO

\$8,500



COSTA DEL ESTE

SPEEDMASTER



311.92.44.51.01.007

REFERENCIA

- CERÁMICA / NATO
- 44.2 MM
- AUTOMÁTICO

\$8,500



OBARRIO

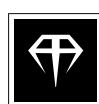

SEAMASTER

SPEEDMASTER

CONSTELLATION

DE VILLE

CONSTELLATION

- ACERO / ORO
- 35 MM
- AUTOMÁTICO



\$2,500



OBARRIO



PAPELES

1212.30.00

REFERENCIA

CONSTELLATION BICOLOR

- ACERO / ORO
- 38 MM
- AUTOMÁTICO



\$8,000



OBARRIO



CAJA



PAPELES

123.20.38.21.03.001

REFERENCIA

CONSTELLATION BICOLOR

- ACERO / ORO
- 34 MM
- QUARTZ



\$2,500



OBARRIO

55296372

REFERENCIA

CONSTELLATION

- ACERO / ORO
- 35.5 MM
- QUARTZ



\$2,800

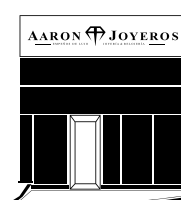

COSTA DEL ESTE

1302.30.00

REFERENCIA

CONSTELLATION

- ACERO / ORO
- 29 MM
- AUTOMÁTICO



\$9,800



OBARRIO

131.20.29.20.05.002

REFERENCIA

SEAMASTER

SPEEDMASTER

CONSTELLATION

DE VILLE

CONSTELLATION QUADRA

"DIAL MADRE PERLA"

- ACERO
- 24 X 19.3 MM
- QUARTZ

\$1,400



1521.7100
REFERENCIA



OBARRIO

CONSTELLATION

- ACERO
- 27 MM
- QUARTZ

\$2,500



123.10.27.60.02.002
REFERENCIA



OBARRIO



CAJA



PAPELES

CONSTELLATION QUADRA DIAMOND

- ACERO / DIAMANTE
- 19 MM
- QUARTZ

\$1,600



1528.76.00
REFERENCIA



OBARRIO

CONSTELLATION

- ACERO
- MM
- QUARTZ

\$4,000



2853
REFERENCIA



OBARRIO

CONSTELLATION

- ACERO
- 19 MM
- QUARTZ

\$1,200



1528.76.00
REFERENCIA



OBARRIO

SEAMASTER

SPEEDMASTER

CONSTELLATION

DE VILLE

DE VILLE
VINTAGE

"BISEL DE DIAMANTES"

ORO BLANCO

25.4 MM

QUARTZ

\$8,000



OBARRIO

VINTAGE
REFERENCIA

DE VILLE

ACERO

41 MM

AUTOMÁTICO

\$3,500



OBARRIO



CAJA

424.10.37.20.03.001
REFERENCIA

DE VILLE
PRESTIGE

ACERO

39.5 MM

AUTOMÁTICO

\$3,500



OBARRIO



CAJA

424.13.40.20.06.002
REFERENCIA

DE VILLE

ACERO / ORO

36.8 MM

AUTOMÁTICO

\$4,000



OBARRIO

424.20.37.20.02.001
REFERENCIA

DE VILLE

ORO

31 MM

QUARTZ

\$4,000



OBARRIO

VINTAGE
REFERENCIA

DE VILLE

"UFO"

ACERO

40 MM

AUTOMÁTICO

\$1,200



OBARRIO

166.094
REFERENCIA



SEAMASTER

SPEEDMASTER

CONSTELLATION

DE VILLE

DE VILLE

-  ORO
-  37.5 MM
-  AUTOMÁTICO

\$30,500





4131.31.00
REFERENCIA



OBARRIO

DE VILLE

-  ACERO / ORO
-  25 MM
-  AUTOMÁTICO

\$1,000





DA 796.2379
REFERENCIA



OBARRIO

DE VILLE

-  ORO
-  37.5 MM
-  AUTOMÁTICO

\$10,500



4631.31.31
REFERENCIA



OBARRIO

ORIS

HÖLSTEIN 1904



OMEGA es una prestigiosa manufactura suiza reconocida por su precisión, innovación y destacada trayectoria dentro de la alta relojería. La firma se ha distinguido por la creación de modelos icónicos como el Speedmaster y el Seamaster, además de su participación en la exploración espacial y el cronometraje deportivo de máximo nivel. Su enfoque combina excelencia técnica, diseño atemporal y espíritu pionero, representando rendimiento, fiabilidad y prestigio dentro del universo de la relojería de lujo.

ORIS

HÖLSTEIN 1904

BIG CROWN



-  ACERO
-  44 MM
-  AUTOMÁTICO

\$1,600





OBARRIO

REF. 7629-40
REFERENCIA

REGULATEUR



-  TITANIO
-  49 MM
-  AUTOMÁTICO

\$1,500



OBARRIO



CAJA





PAPELES

01 649 7610
REFERENCIA

AQUIS DEPTH GAUGE



-  ACERO
-  48 MM
-  AUTOMÁTICO

\$4,000



OBARRIO

01 774 7708 4154-SET RS
REFERENCIA

PANERAI

Panerai es una distintiva manufactura de relojería reconocida por su herencia italiana, desarrollo suizo y diseño inconfundible. La firma se ha destacado por crear relojes inspirados en instrumentos militares y de buceo, caracterizados por sus cajas robustas, gran legibilidad y fuerte presencia estética. Su enfoque combina tradición, ingeniería técnica y funcionalidad, representando carácter, exclusividad y espíritu aventurero dentro de la relojería de lujo contemporánea.

AARON  **JOYEROS**

— JOYERIA & RELOJERIA —

PANERAI



FERRARRI

SCUDERIA



ACERO



45 MM



AUTOMÁTICO

\$5,000



CAJA



PAPELES



OBARRIO

FER00008

REFERENCIA



AARON  JOYEROS

PANERAI

FERRARI CRONÓGRAFO



-  ACERO
-  45 MM
-  AUTOMÁTICO

\$6,500



OBARRIO



CAJA





PAPELES

FER00004
REFERENCIA

FERRARI CRONÓGRAFO



-  ACERO
-  45 MM
-  AUTOMÁTICO

\$6,500

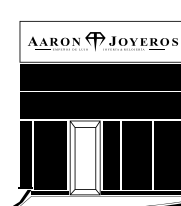



COSTA DEL ESTE

FER00005
REFERENCIA

MARINA MILITARE



-  ACERO
-  47 MM
-  AUTOMÁTICO

\$9,500



OBARRIO



CAJA



PAPELES

PAM673
REFERENCIA

RADIOMIR BLACK SEAL



-  ACERO
-  45 MM
-  CUERDA MANUAL

\$4,200



OBARRIO

PAM00183
REFERENCIA

LUMINOR BLACK SEAL



-  ACERO
-  47 MM
-  AUTOMÁTICO

\$5,500



OBARRIO

PAM0514
REFERENCIA

LUMINOR



-  ACERO
-  44 MM
-  CUERDA MANUAL

\$3,900





OBARRIO

PAM112
REFERENCIA

PANERAI

LUMINOR RATTRAPANTE

-  ACERO
-  44 MM
-  AUTOMÁTICO



\$7,300



OBARRIO

PAM00213
REFERENCIA

RADIOMIR MILITARE

-  CERÁMICA
-  47 MM
-  AUTOMÁTICO

\$9,000





OBARRIO

PAM00339
REFERENCIA



PAPELES

LUMINOR

-  ACERO
-  44 MM
-  AUTOMÁTICO



\$4,400



OBARRIO

OP6728
REFERENCIA

LUMINOR

-  ACERO
-  47 MM
-  AUTOMÁTICO

\$7,000





OBARRIO

PAM00305
REFERENCIA



SUBMERSIBLE

-  ACERO
-  42 MM
-  AUTOMÁTICO



\$7,500



OBARRIO

PAM00959
REFERENCIA

LUMINOR

-  ACERO
-  47 MM
-  AUTOMÁTICO

\$6,000



OBARRIO

PAM372
REFERENCIA



CAJA



PAPELES

PANERAI

LUMINOR



ACERO

44 MM

AUTOMÁTICO

\$6,000



OBARRIO

PAM00024

REFERENCIA

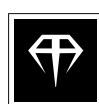



CHARRIOL
GENEVE

Philippe Charriol es una distinguida firma de lujo reconocida por su creatividad, elegancia y una identidad de diseño única dentro del universo relojero. La marca se ha destacado por incorporar sus característicos motivos de cables trenzados en relojes que combinan sofisticación, originalidad y una fuerte personalidad estética. Su enfoque une innovación, refinamiento y estilo contemporáneo, representando exclusividad, carácter y distinción dentro de la relojería de lujo.

AARON  **JOYEROS**

— JOYERIA & RELOJERIA —

CHARRIOL



 ACERO / BAÑO DE ORO

 33.5 MM

 QUARTZ

\$1,000



OBARRIO

53.98.3797

REFERENCIA

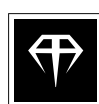

PIAGET

Philippe Charriol es una distinguida firma de lujo reconocida por su creatividad, elegancia y una identidad de diseño única dentro del universo relojero. La marca se ha destacado por incorporar sus característicos motivos de cables trenzados en relojes que combinan sofisticación, originalidad y una fuerte personalidad estética. Su enfoque une innovación, refinamiento y estilo contemporáneo, representando exclusividad, carácter y distinción dentro de la relojería de lujo.

AARON  JOYEROS

— JOYERIA & RELOJERIA —

POSSESSION



 ORO BLANCO

 28 MM

 QUARTZ

\$5,000



OBARRIO



CAJA



PAPELES

1009275

REFERENCIA

MISS PROTOCOLE

XL



 BISEL DIAMANTE

 40 X 36 MM

 QUARTZ

\$8,500

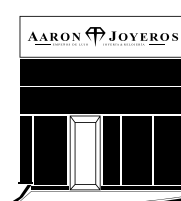

COSTA DEL ESTE

P10206

REFERENCIA

ALTIPLANO CLOUS DE PARÍS



 ORO

 26 MM

 AUTOMÁTICO

\$4,000



OBARRIO

549551

REFERENCIA

RECTANGLE L'ANTIGUA XL



 ACERO

 31 X 46 MM

 AUTOMÁTICO

\$15,200

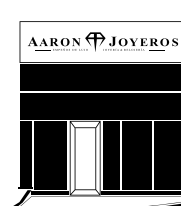

COSTA DEL ESTE

PI0076

REFERENCIA

HABANA CUERVOS Y SOBRINOS



 ACERO / ORO

 33 MM

 CUERDA MANUAL

\$700



OBARRIO

26310R.00

REFERENCIA

TANAGRA



 ORO

 24 MM

 QUARTZ

\$11,850

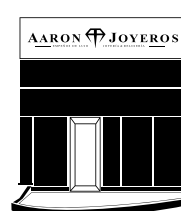

COSTA DEL ESTE

16033

REFERENCIA

POLO



24005 M 501 D
REFERENCIA

 ORO / DIAMANTES

 34 MM

 AUTOMÁTICO

\$20,000



OBARRIO

VINTAGE



4154
REFERENCIA

 ORO

 20 MM

 AUTOMÁTICO

\$2,200



OBARRIO



RW
RAYMOND WEIL
GENEVE

Raymond Weil es una reconocida casa suiza de relojería distinguida por su elegancia, tradición familiar y compromiso con la excelencia artesanal. La firma se ha destacado por crear relojes que combinan precisión suiza, diseño refinado y una fuerte inspiración en el mundo de la música y las artes. Su enfoque une sofisticación, innovación y accesibilidad dentro del segmento de lujo, representando calidad, armonía y estilo atemporal en la relojería contemporánea.

**ELECTROPLATED
 VINTAGE**



-  BAÑO DE ORO
-  28 MM
-  QUARTZ

\$500





OBARRIO

9022

REFERENCIA

NABUCCO



-  ACERO
-  44 MM
-  AUTOMÁTICO

\$600



OBARRIO





CAJA

3900

REFERENCIA

**DON GIOVANNI
 COSI GRANDE**



-  ACERO
-  29.5 x 31 MM
-  QUARTZ

\$1,200





OBARRIO

2671-ST-00209

REFERENCIA

**TOCCATA
 CLASSIC**



-  ACERO
-  42 MM
-  QUARTZ

\$900



OBARRIO



CAJA



PAPELES

5585-ST-60001

REFERENCIA

TANGO



-  ACERO
-  41 MM
-  QUARTZ

\$750



OBARRIO

8260-ST7-20001

REFERENCIA



REVUE THOMMEN
Since 1853

Revue Thommen es una histórica manufactura suiza reconocida por su precisión, fiabilidad y estrecha relación con la aviación y la instrumentación profesional. La firma se ha destacado por desarrollar relojes robustos y funcionales que combinan excelencia técnica, legibilidad y una sólida tradición relojera. Su enfoque une innovación, rendimiento y artesanía suiza, representando autenticidad, durabilidad y calidad dentro de la relojería contemporánea.

REVUE THOMMEN
Since 1853

REVUE THOMMEN



ACERO

40 MM

AUTOMÁTICO

\$1,000



COSTA DEL ESTE



CAJA



PAPELES

7001.6

REFERENCIA

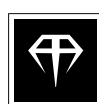



ROGER DUBUIS

Roger Dubuis es una exclusiva manufactura suiza reconocida por su innovación, audacia y enfoque vanguardista dentro de la alta relojería. La firma se ha destacado por desarrollar movimientos de gran complejidad y diseños arquitectónicos que desafían los códigos tradicionales, combinando excelencia mecánica con una estética contemporánea. Su enfoque une creatividad, tecnología y artesanía de alto nivel, representando exclusividad, rendimiento y una visión disruptiva de la relojería de lujo.

AARON  JOYEROS

— JOYERIA & RELOJERIA —

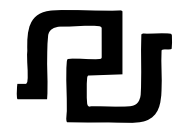

ROGER DUBUIS

PULSION



 ORO ROSA

 44 MM

 AUTOMÁTICO

\$25,000



OBARRIO

RDDDBPU003
REFERENCIA



\$43,900

PRECIO RETAIL



Rolex es una de las manufacturas más prestigiosas y reconocidas del mundo, distinguida por su precisión, innovación y excelencia en la relojería suiza. La firma se ha destacado por la creación de modelos icónicos como el Submariner, Datejust, Daytona y GMT-Master, que se han convertido en referentes de rendimiento y diseño atemporal. Su enfoque combina fiabilidad, ingeniería avanzada y tradición, representando prestigio, exclusividad y liderazgo dentro del universo de la alta relojería.

AIR KING

DAYTONA

DATEJUST

DAY-DATE

EXPLORER

GMT-MASTER

MILGAUSS

OYSTER PERP.

SEA-DWELLER

SKY-DWELLER

SUBMARINER

YACHT-MASTER

AIR KING



ACERO



34 MM



AUTOMÁTICO

\$4,000



AIR KING

DAYTONA

DATEJUST

DAY-DATE

EXPLORER

GMT-MASTER

MILGAUSS

OYSTER PERP.

SEA-DWELLER

SKY-DWELLER

SUBMARINER

YACHT-MASTER

AIR KING
PRECISION



ACERO

34 MM

AUTOMÁTICO

\$4,800



OBARRIO

14000

REFERENCIA

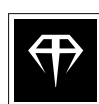

AIR KING	DAYTONA	DATEJUST	DAY-DATE	EXPLORER	GMT-MASTER
MILGAUSS	OYSTER PERP.	SEA-DWELLER	SKY-DWELLER	SUBMARINER	YACHT-MASTER

116508
REFERENCIA



- ORO
- 40 MM
- AUTOMÁTICO

\$75,000

DAYTONA

JOHN

MAYER



OBARRIO

AIR KING

DAYTONA

DATEJUST

DAY-DATE

EXPLORER

GMT-MASTER

MILGAUSS

OYSTER PERP.

SEA-DWELLER

SKY-DWELLER

SUBMARINER

YACHT-MASTER

DAYTONA

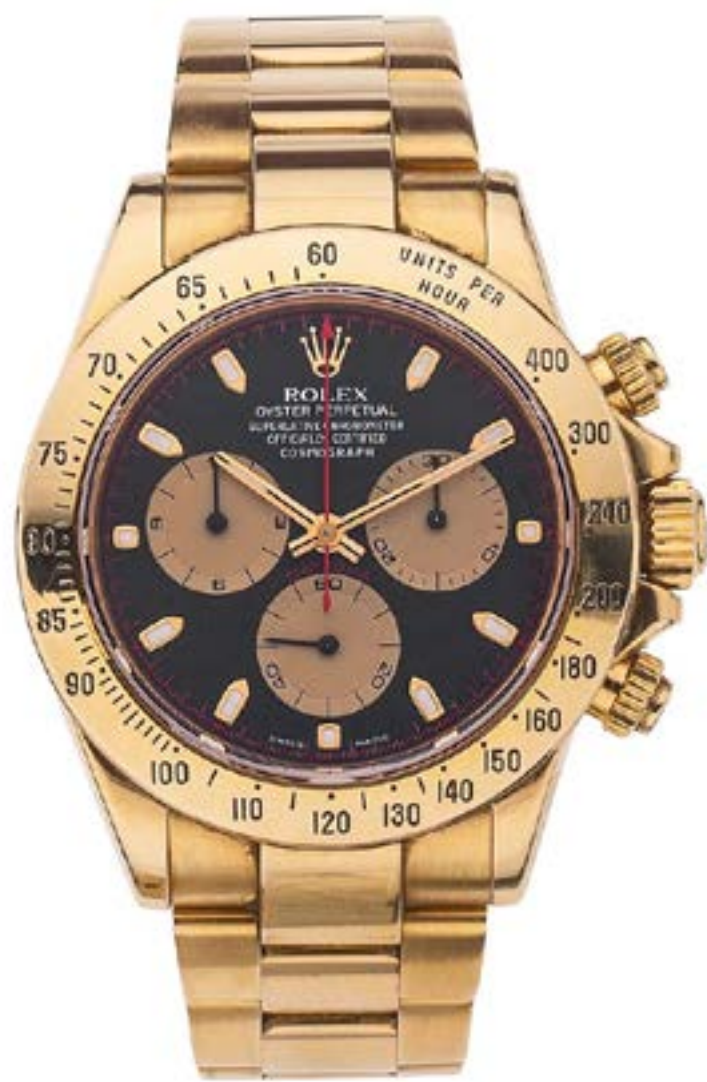

- ORO
- 40 MM
- AUTOMÁTICO

\$35,000



OBARRIO

CAJA

116528

REFERENCIA

DAYTONA COSMOGRAPH

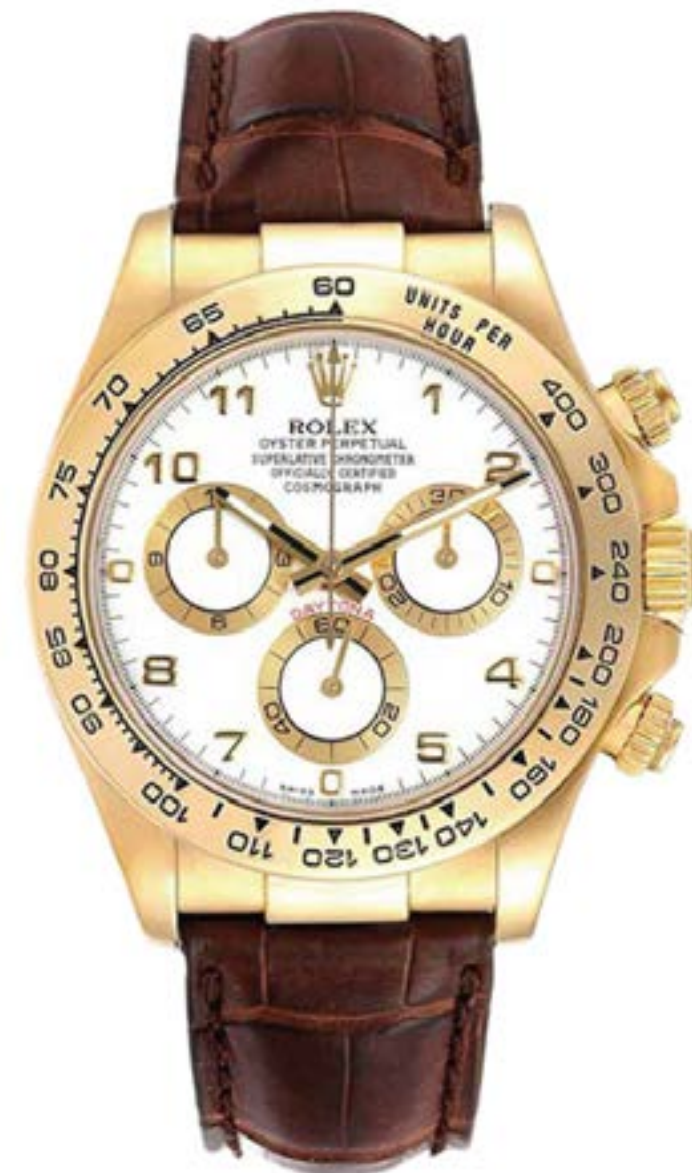

- ORO
- 40 MM
- AUTOMÁTICO

\$35,000



COSTA DEL ESTE

116518

REFERENCIA

DAYTONA COSMOGRAPH



- ACERO
- 40 MM
- AUTOMÁTICO

\$24,000

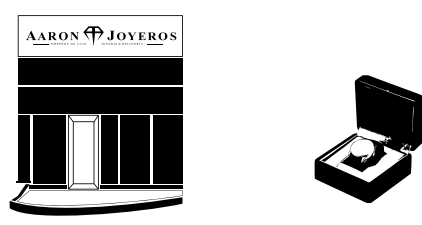

COSTA DEL ESTE

CAJA

116520

REFERENCIA

DAYTONA



- ACERO / ORO
- 40 MM
- AUTOMÁTICO

\$21,000

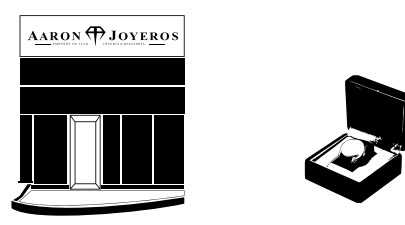

COSTA DEL ESTE

CAJA

116523

REFERENCIA

DAYTONA OYSTER FLEX



- ACERO
- MM
- AUTOMÁTICO

\$30,000



OBARRIO

CAJA

PAPELES

16518

REFERENCIA

DAYTONA

"MOVIMIENTO ZENITH"

- ACERO / ORO
- 40 MM
- AUTOMÁTICO

\$19,500



OBARRIO



16523

REFERENCIA

AIR KING

DAYTONA

DATEJUST

DAY-DATE

EXPLORER

GMT-MASTER

MILGAUSS

OYSTER PERP.

SEA-DWELLER

SKY-DWELLER

SUBMARINER

YACHT-MASTER

DAYTONA



- ACERO
- 40 MM
- AUTOMÁTICO

\$23,000



OBARRIO



CAJA

116520

REFERENCIA

DAYTONA



- ORO BLANCO
- 40 MM
- AUTOMÁTICO

\$35,000



OBARRIO



CAJA



PAPELES

116509

REFERENCIA

DAYTONA



- ACERO
- 40 MM
- AUTOMÁTICO

\$22,500



OBARRIO



CAJA

116520

REFERENCIA

DAYTONA



- ACERO
- 40 MM
- AUTOMÁTICO

\$23,000



OBARRIO

116520

REFERENCIA

AIR KING	DAYTONA	DATEJUST	DAY-DATE	EXPLORER	GMT-MASTER
MILGAUSS	OYSTER PERP.	SEA-DWELLER	SKY-DWELLER	SUBMARINER	YACHT-MASTER

DATEJUST
WIMBLEDON

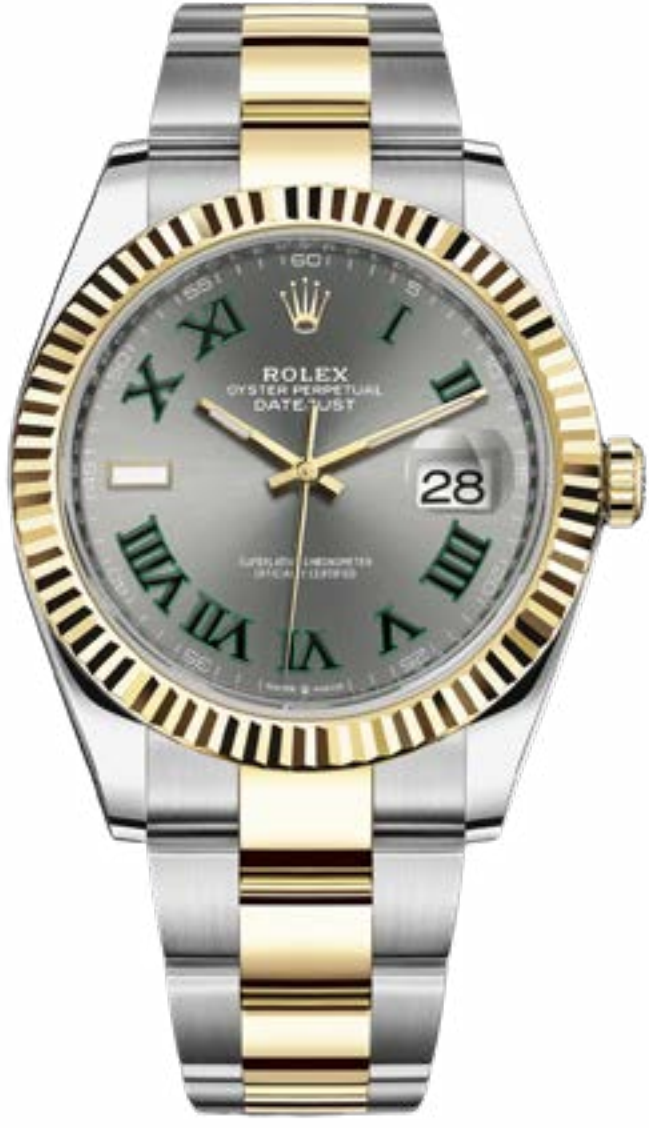

- ACERO / ORO
- 41 MM
- AUTOMÁTICO

\$16,500

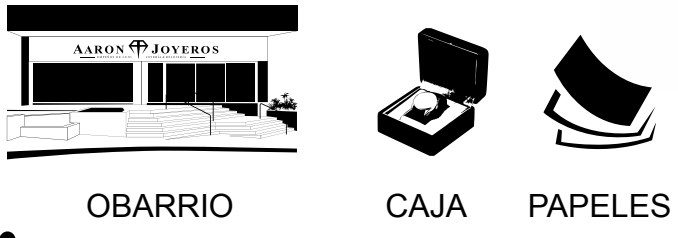

126333

REFERENCIA

DATEJUST
WIMBLEDON



- ACERO / ORO
- 41 MM
- AUTOMÁTICO

\$15,500



116333

REFERENCIA

DATEJUST
WIMBLEDON



- ACERO / ORO
- 41 MM
- AUTOMÁTICO

\$13,800



116333

REFERENCIA

DATEJUST
WIMBLEDON



- ACERO / ORO
- 41 MM
- AUTOMÁTICO

\$14,000



116333

REFERENCIA

DATEJUST
WIMBLEDON



- ACERO / ORO
- 41 MM
- AUTOMÁTICO

\$13,500



0000

REFERENCIA

DATEJUST
WIMBLEDON



- ACERO
- 41 MM
- AUTOMÁTICO

\$14,500

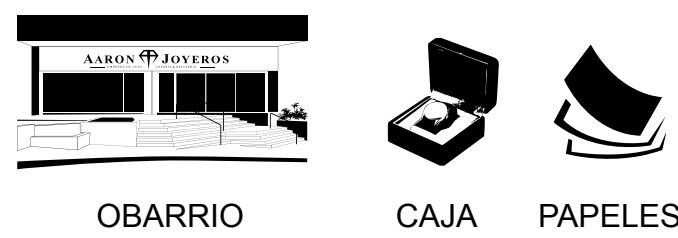

126300

REFERENCIA

- AIR KING
- DAYTONA
- DATEJUST
- DAY-DATE
- EXPLORER
- GMT-MASTER
- MILGAUSS
- OYSTER PERP.
- SEA-DWELLER
- SKY-DWELLER
- SUBMARINER
- YACHT-MASTER

DATEJUST



 ACERO / ORO ROSA

 36 MM

 AUTOMÁTICO

\$13,500



OBARRIO



CAJA



PAPELES

116231

REFERENCIA



AIR KING	DAYTONA	DATEJUST	DAY-DATE	EXPLORER	GMT-MASTER
MILGAUSS	OYSTER PERP.	SEA-DWELLER	SKY-DWELLER	SUBMARINER	YACHT-MASTER

DATEJUST

"PEARLMASTER"

- ORO ROSA
- 34 MM
- AUTOMÁTICO



\$37,000

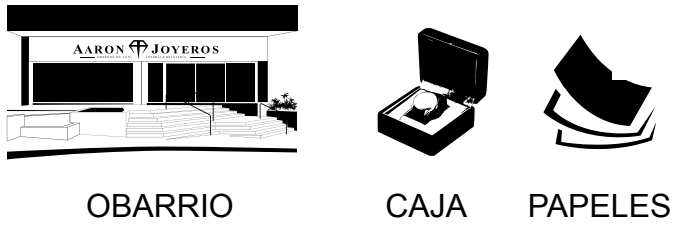

81315

REFERENCIA

DATEJUST LADY

- ACERO
- 26 MM
- AUTOMÁTICO

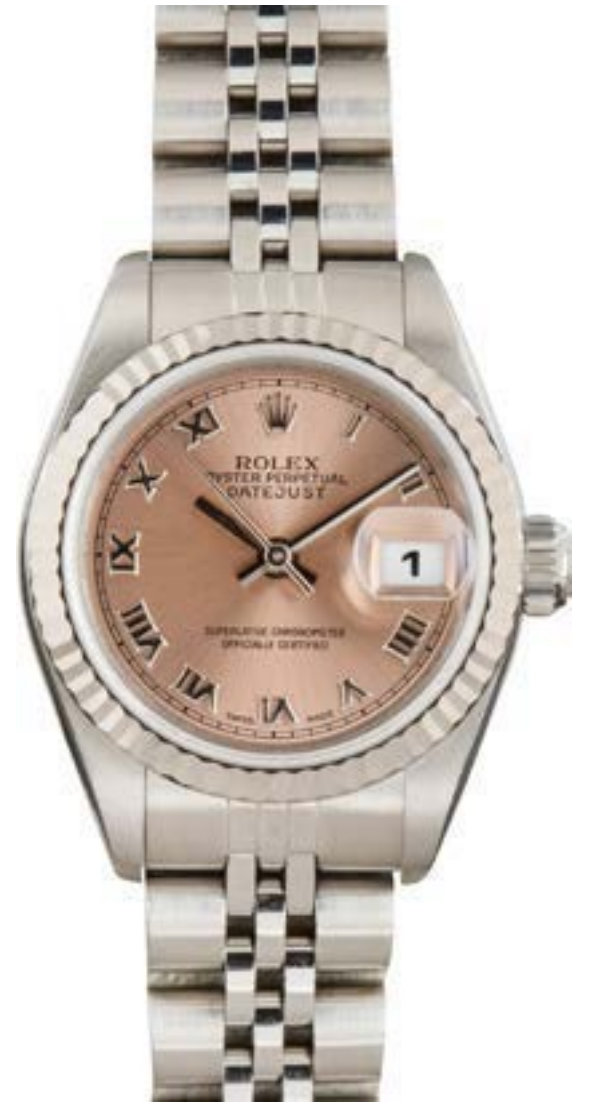

\$6,500

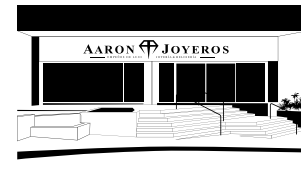

69174

REFERENCIA

DATEJUST

- ACERO / ORO
- 26 MM
- AUTOMÁTICO



\$9,500



179161

REFERENCIA

DATEJUST

- ACERO / ORO ROSA
- 41 MM
- AUTOMÁTICO



\$16,000

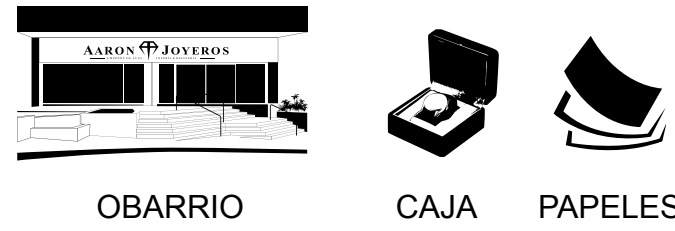

126301

REFERENCIA

DATEJUST

"PEARLMASTER"

- ACERO
- 26 MM
- AUTOMÁTICO



\$9,500



179174

REFERENCIA

DATEJUST

- ACERO / ORO ROSA
- 41 MM
- AUTOMÁTICO



\$14,000



126301

REFERENCIA

AIR KING	DAYTONA	DATEJUST	DAY-DATE	EXPLORER	GMT-MASTER
MILGAUSS	OYSTER PERP.	SEA-DWELLER	SKY-DWELLER	SUBMARINER	YACHT-MASTER

DATEJUST



- ORO ROSA
- 26 MM
- AUTOMÁTICO

\$15,000

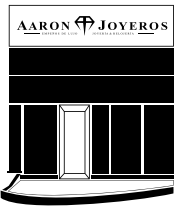

COSTA DEL ESTE

179165

REFERENCIA

DATEJUST



- ACERO / ORO
- 26 MM
- AUTOMÁTICO

\$6,500



OBARRIO

69173

REFERENCIA

DATEJUST



- ORO ROSA
- 26 MM
- AUTOMÁTICO

\$15,000



OBARRIO

179165

REFERENCIA

DATEJUST



- ACERO
- MM31
- AUTOMÁTICO

\$10,500



COSTA DEL ESTE

278240

REFERENCIA

DATEJUST

"PEARLMASTER"



- ORO / DIAMANTES
- 29 MM
- AUTOMÁTICO

\$30,000

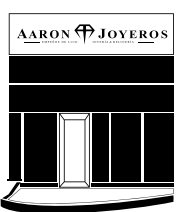

COSTA DEL ESTE

80318

REFERENCIA

DATEJUST



- ACERO / ORO
- 41 MM
- AUTOMÁTICO

\$17,000



OBARRIO



CAJA

126333

REFERENCIA

- AIR KING
- DAYTONA
- DATEJUST
- DAY-DATE
- EXPLORER
- GMT-MASTER
- MILGAUSS
- OYSTER PERP.
- SEA-DWELLER
- SKY-DWELLER
- SUBMARINER
- YACHT-MASTER

DATEJUST

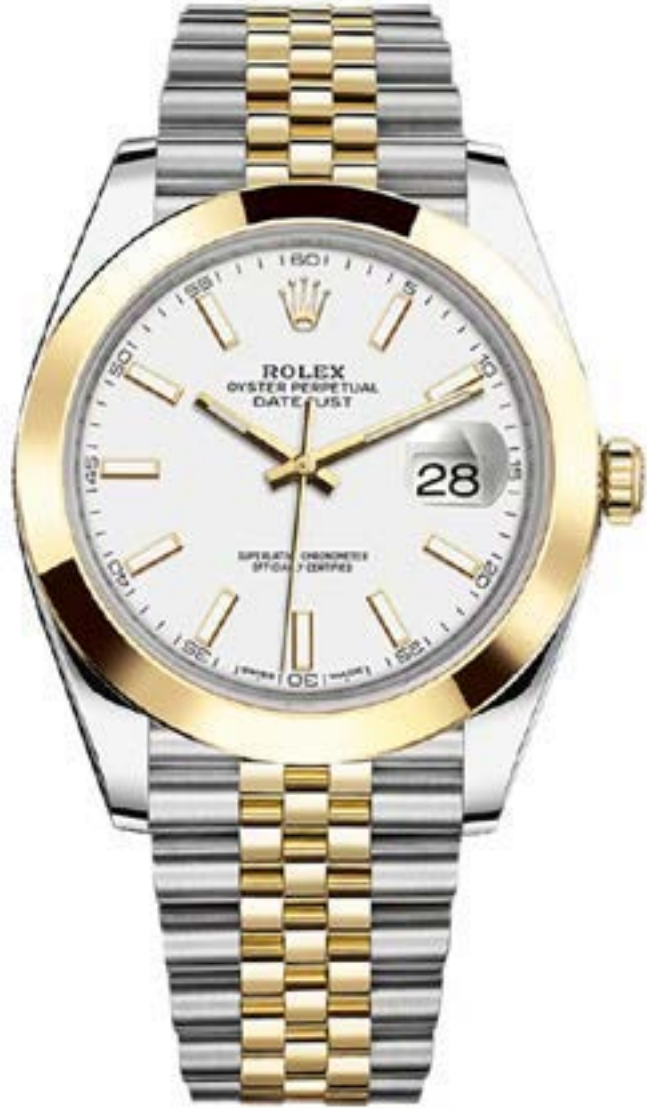

- ACERO / ORO
- 41 MM
- AUTOMÁTICO

\$16,500

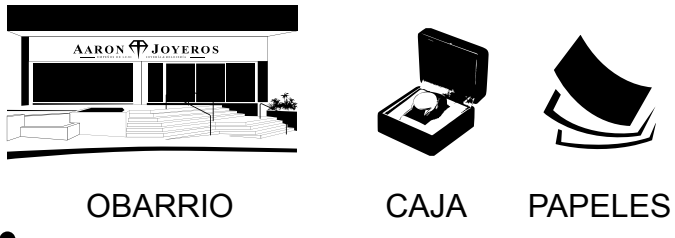

126303

REFERENCIA

DATEJUST



- ACERO / ORO
- 26 MM
- AUTOMÁTICO

\$5,500



69173

REFERENCIA

DATEJUST



- ACERO / ORO
- 36 MM
- AUTOMÁTICO

\$6,500

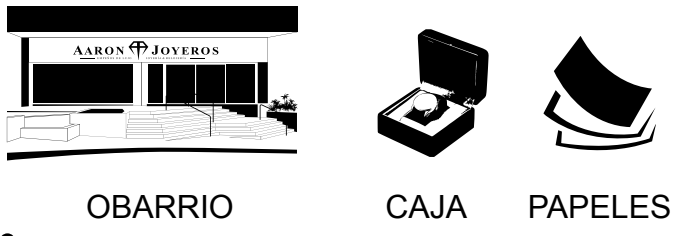

15053

REFERENCIA

DATEJUST



- ACERO / ORO
- 26 MM
- AUTOMÁTICO

\$5,500



69173

REFERENCIA

DATEJUST



- ACERO / ORO
- 31 MM
- AUTOMÁTICO

\$17,000



178313

REFERENCIA

DATEJUST



- ACERO / ORO
- 26 MM
- AUTOMÁTICO

\$4,800



69173

REFERENCIA

- AIR KING
- DAYTONA
- DATEJUST
- DAY-DATE
- EXPLORER
- GMT-MASTER
- MILGAUSS
- OYSTER PERP.
- SEA-DWELLER
- SKY-DWELLER
- SUBMARINER
- YACHT-MASTER

DATEJUST



- ACERO / ORO / DIAMANTES
- 41 MM
- AUTOMÁTICO

\$14,000

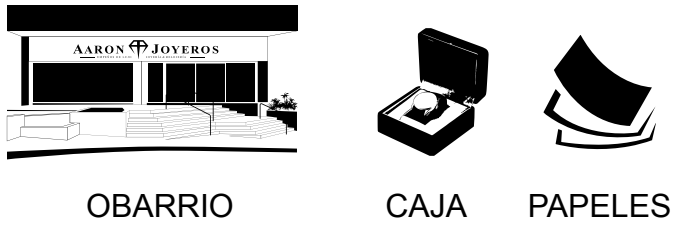

116333
REFERENCIA

DATEJUST



- ORO
- 31 MM
- AUTOMÁTICO

\$14,000



6827
REFERENCIA

DATEJUST



- ORO
- 34 MM
- AUTOMÁTICO

\$20,000



1500
REFERENCIA

DATEJUST



- ORO
- 31 MM
- AUTOMÁTICO

\$8,500



6701
REFERENCIA

DATEJUST



- ORO
- 36 MM
- AUTOMÁTICO

\$15,500



6605
REFERENCIA

DATEJUST



- ACERO / ORO
- 36 MM
- AUTOMÁTICO

\$6,500



16233
REFERENCIA

AIR KING

DAYTONA

DATEJUST

DAY-DATE

EXPLORER

GMT-MASTER

MILGAUSS

OYSTER PERP.

SEA-DWELLER

SKY-DWELLER

SUBMARINER

YACHT-MASTER

DATEJUST

"PULSO NO ORIGINAL DE PLATA"

- ORO
- 36 MM
- AUTOMÁTICO



\$8,500



OBARRIO

16018

REFERENCIA

DATEJUST

- ACERO
- 36 MM
- AUTOMÁTICO



\$5,000



OBARRIO



CAJA



PAPELES

1603

REFERENCIA

DATEJUST

- ACERO / ORO
- 26 MM
- AUTOMÁTICO



\$4,500



OBARRIO

6917

REFERENCIA

DATEJUST

- ORO
- 36 MM
- AUTOMÁTICO



\$15,000



OBARRIO

1601

REFERENCIA

DATE

- ACERO / ORO
- 26 MM
- AUTOMÁTICO



\$4,000



OBARRIO



CAJA



PAPELES

6917

REFERENCIA

DATE

- ACERO
- 24 MM
- AUTOMÁTICO



\$2,500



OBARRIO

6516

REFERENCIA

AIR KING
MILGAUSS

DAYTONA
OYSTER PERP.

DATEJUST
SEA-DWELLER

DAY-DATE
SKY-DWELLER

EXPLORER
SUBMARINER

GMT-MASTER
YACHT-MASTER

DATEJUST



- ACERO
- 36 MM
- AUTOMÁTICO

\$6,200



OBARRIO

16220

REFERENCIA

DATEJUST



- ACERO / ORO
- 41 MM
- AUTOMÁTICO

\$11,000



OBARRIO

116334

REFERENCIA

DATEJUST



- ACERO / ORO
- 41 MM
- AUTOMÁTICO

\$12,000



OBARRIO

126334

REFERENCIA

DATEJUST



- ACERO
- 36 MM
- AUTOMÁTICO

\$6,500



OBARRIO

16030

REFERENCIA

DATEJUST



- ACERO / ORO
- 36 MM
- AUTOMÁTICO

\$11,000



OBARRIO

116334

REFERENCIA

DATEJUST

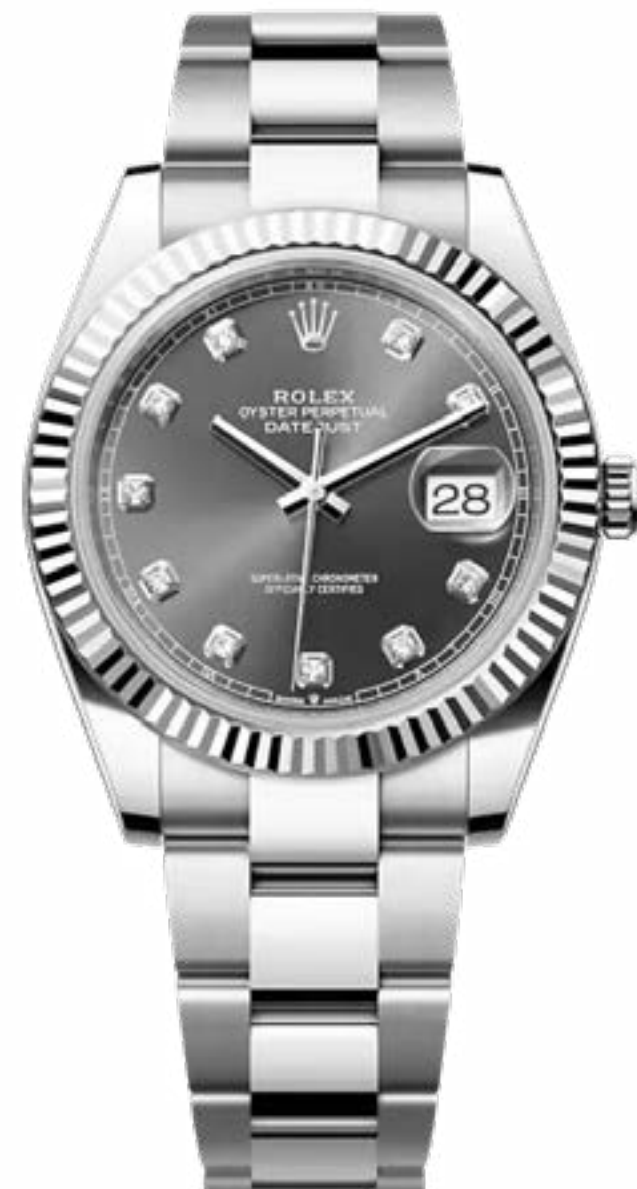

- ACERO / ORO / DIAMANTES
- 41 MM
- AUTOMÁTICO

\$16,000



OBARRIO



CAJA



PAPELES

126334

REFERENCIA

AIR KING
MILGAUSS

DAYTONA
OYSTER PERP.

DATEJUST
SEA-DWELLER

DAY-DATE
SKY-DWELLER

EXPLORER
SUBMARINER

GMT-MASTER
YACHT-MASTER

DATEJUST

“BISEL DE ORO BLANCO”

- ACERO / ORO
- 41 MM
- AUTOMÁTICO



\$11,500



OBARRIO

116334

REFERENCIA

DATEJUST

- ACERO
- 41 MM
- AUTOMÁTICO



\$9,500



OBARRIO

116300

REFERENCIA

DATEJUST

“BISEL DE ORO BLANCO”

- ACERO / ORO
- 41 MM
- AUTOMÁTICO



\$11,500



OBARRIO

116334

REFERENCIA

DATEJUST

- ACERO / ORO
- 41 MM
- AUTOMÁTICO



\$10,800



OBARRIO

116334

REFERENCIA

AIR KING	DAYTONA	DATEJUST	DAY-DATE	EXPLORER	GMT-MASTER
MILGAUSS	OYSTER PERP.	SEA-DWELLER	SKY-DWELLER	SUBMARINER	YACHT-MASTER

DATEJUST



- ACERO / DIAMANTES
- 26 MM
- AUTOMÁTICO

\$9,000

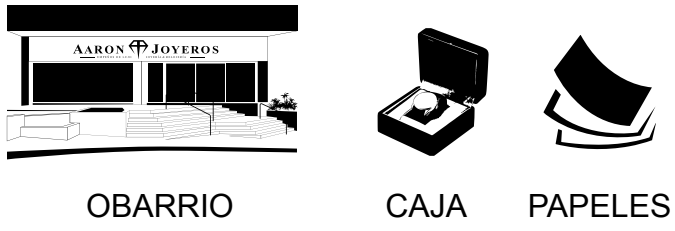

179174

REFERENCIA

DATEJUST



- ACERO
- 36 MM
- AUTOMÁTICO

\$5,500



OBARRIO

16030

REFERENCIA

DATEJUST

“BISEL DE ORO”



- ACERO / ORO
- 41 MM
- AUTOMÁTICO

\$11,000

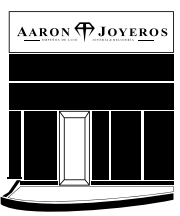

COSTA DEL ESTE

116334

REFERENCIA

DATEJUST

“BISEL DE ORO”



- ACERO / ORO
- 41 MM
- AUTOMÁTICO

\$11,000



OBARRIO

116334

REFERENCIA

DATEJUST

- ACERO / ORO
- 41 MM
- AUTOMÁTICO

\$11,000



OBARRIO

116334

REFERENCIA

DATEJUST

- ACERO
- 41 MM
- AUTOMÁTICO

\$10,000



OBARRIO

126300

REFERENCIA

AIR KING

DAYTONA

DATEJUST

DAY-DATE

EXPLORER

GMT-MASTER

MILGAUSS

OYSTER PERP.

SEA-DWELLER

SKY-DWELLER

SUBMARINER

YACHT-MASTER

DATEJUST



- ACERO
- 41 MM
- AUTOMÁTICO

\$9,500



OBARRIO

116300

REFERENCIA

DATEJUST



- ACERO
- 41 MM
- AUTOMÁTICO

\$10,500



OBARRIO



CAJA



PAPELES

116300

REFERENCIA

DATEJUST



- ACERO
- 36 MM
- AUTOMÁTICO

\$8,650



COSTA DEL ESTE



CAJA



PAPELES

116200

REFERENCIA

DATEJUST



- ORO
- 36 MM
- AUTOMÁTICO

\$12,000



OBARRIO

116139

REFERENCIA

DATEJUST



- ACERO / ORO BLANCO
- 41 MM
- AUTOMÁTICO

\$16,000



OBARRIO



CAJA



PAPELES

126334

REFERENCIA

- AIR KING
- DAYTONA
- DATEJUST
- DAY-DATE
- EXPLORER
- GMT-MASTER
- MILGAUSS
- OYSTER PERP.
- SEA-DWELLER
- SKY-DWELLER
- SUBMARINER
- YACHT-MASTER

DAY-DATE



- ORO BLANO
- 41 MM
- AUTOMÁTICO

\$39,800



218239

REFERENCIA

DAY-DATE



- ORO BLANO
- 36 MM
- AUTOMÁTICO

\$22,000



18239

REFERENCIA

DAY-DATE

"DIAL LAPISLAZULI Y DIAMANTES AFTERMARKET"



- ORO
- 36 MM
- AUTOMÁTICO

\$25,000



18238

REFERENCIA

DAY-DATE



- ORO
- 36 MM
- AUTOMÁTICO

\$17,800



1803

REFERENCIA

DAY-DATE



- ORO
- 36 MM
- AUTOMÁTICO

\$23,000



18038

REFERENCIA

DAY-DATE

"CONFETI DIAL"



- ORO
- 36 MM
- AUTOMÁTICO

\$24,000



1803

REFERENCIA

- AIR KING
- DAYTONA
- DATEJUST
- DAY-DATE
- EXPLORER
- GMT-MASTER
- MILGAUSS
- OYSTER PERP.
- SEA-DWELLER
- SKY-DWELLER
- SUBMARINER
- YACHT-MASTER

DAY-DATE



- ORO
- 36 MM
- AUTOMÁTICO

\$20,000



OBARRIO

18038

REFERENCIA

DAY-DATE



- ORO
- 36 MM
- AUTOMÁTICO

\$23,000



COSTA DEL ESTE

18238

REFERENCIA

DAY-DATE



- ORO
- 36 MM
- AUTOMÁTICO

\$20,500



OBARRIO



CAJA

18238

REFERENCIA

DAY-DATE

"BISEL CON DIAMANTES"



- ORO
- 36 MM
- AUTOMÁTICO

\$15,000



OBARRIO

1803

REFERENCIA

DAY-DATE



- ORO
- 36 MM
- AUTOMÁTICO

\$9,000



OBARRIO

1803

REFERENCIA

DAY-DATE



- ORO
- 36 MM
- AUTOMÁTICO

\$16,800



OBARRIO

1803

REFERENCIA

AIR KING

DAYTONA

DATEJUST

DAY-DATE

EXPLORER

GMT-MASTER

MILGAUSS

OYSTER PERP.

SEA-DWELLER

SKY-DWELLER

SUBMARINER

YACHT-MASTER

DAY-DATE



- ORO BLANCO
- 36 MM
- AUTOMÁTICO

\$25,500



OBARRIO



CAJA



PAPELES

118209

REFERENCIA

DAY-DATE

"COSTUM BEZEL & DIAL"



- ORO
- 36 MM
- AUTOMÁTICO

\$15,000



OBARRIO

1803

REFERENCIA

DAY-DATE



- ORO / DIAMANTES
- 36 MM
- AUTOMÁTICO

\$19,400



OBARRIO



CAJA

18038

REFERENCIA

DAY-DATE

"BISEL CON DIAMANTES"



- ORO
- 36 MM
- AUTOMÁTICO

\$22,000

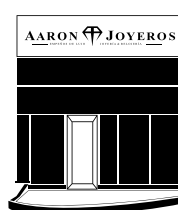

COSTA DEL ESTE

18048

REFERENCIA

DAY-DATE

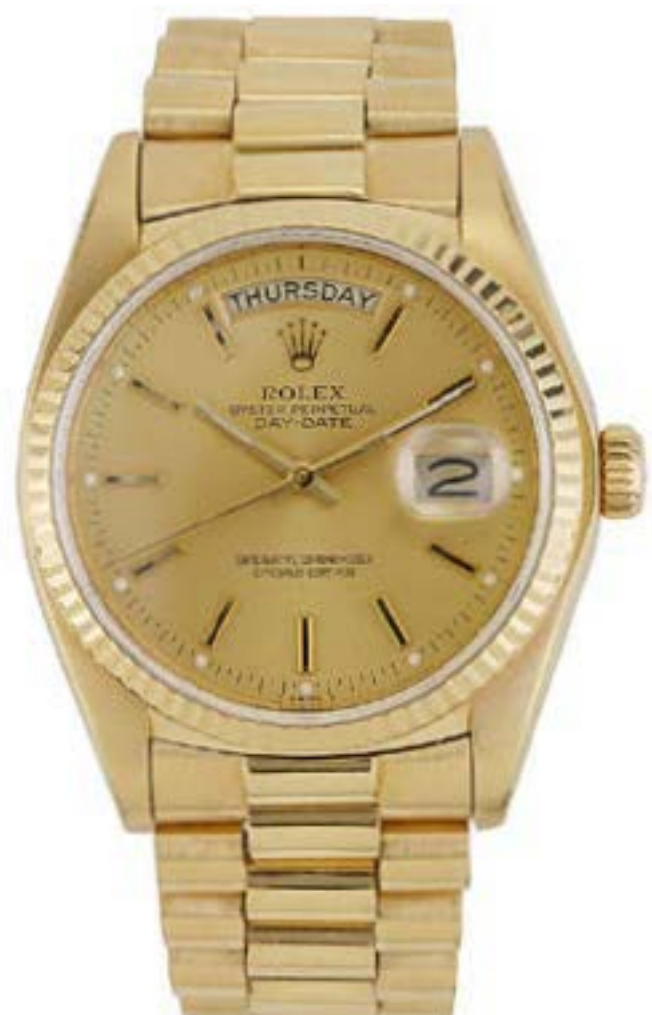

- ORO
- 36 MM
- AUTOMÁTICO

\$16,600



OBARRIO

1803

REFERENCIA

DAY-DATE

"DIAL DE DIAMANTES"



- ORO / DIAMANTES
- 36 MM
- AUTOMÁTICO

\$21,050



OBARRIO

18238

REFERENCIA

- AIR KING
- DAYTONA
- DATEJUST
- DAY-DATE
- EXPLORER
- GMT-MASTER
- MILGAUSS
- OYSTER PERP.
- SEA-DWELLER
- SKY-DWELLER
- SUBMARINER
- YACHT-MASTER

DAY-DATE

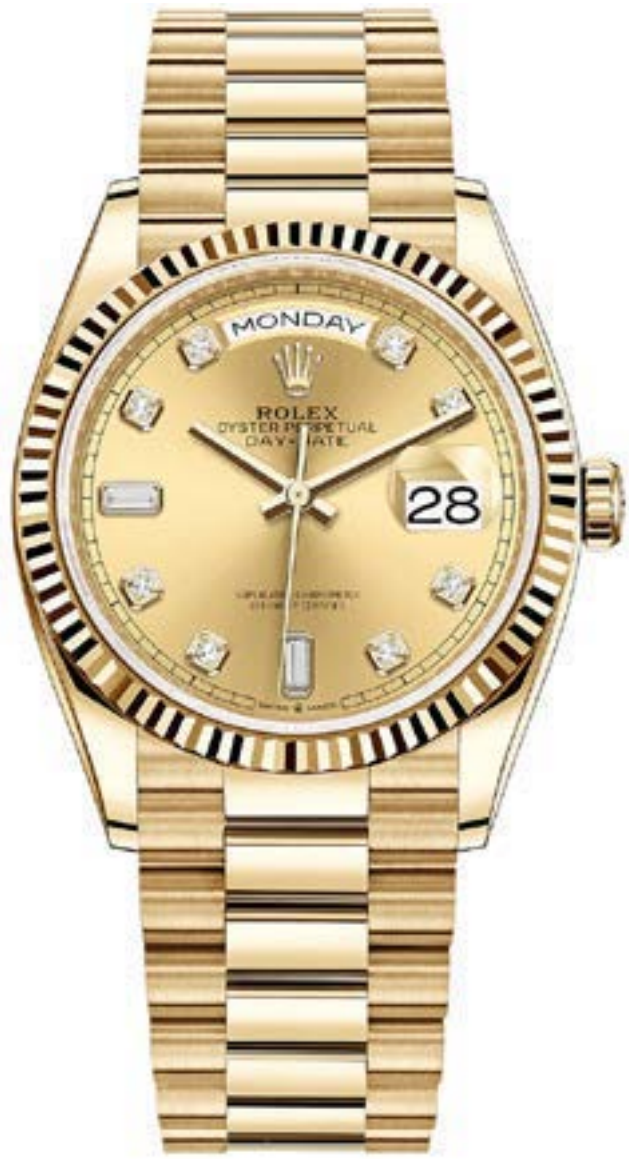

- ORO
- 36 MM
- AUTOMÁTICO

\$46,000

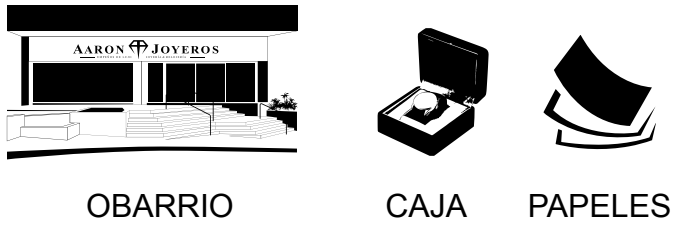

128238
REFERENCIA

DAY-DATE



- ORO
- 40 MM
- AUTOMÁTICO

\$48,000

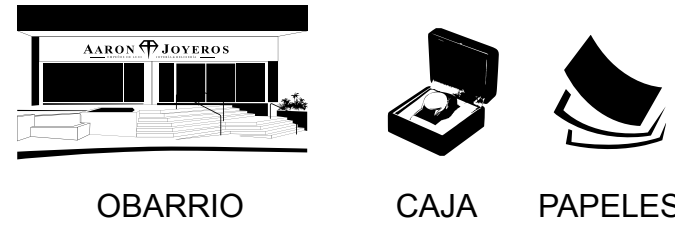

228238
REFERENCIA

DAY-DATE



- ORO ROSA
- 40 MM
- AUTOMÁTICO

\$48,000



228235
REFERENCIA

DAY-DATE



- ORO
- 36 MM
- AUTOMÁTICO

\$17,000



18038
REFERENCIA

- AIR KING
- DAYTONA
- DATEJUST
- DAY-DATE
- EXPLORER
- GMT-MASTER
- MILGAUSS
- OYSTER PERP.
- SEA-DWELLER
- SKY-DWELLER
- SUBMARINER
- YACHT-MASTER

EXPLORER II



- ACERO
- 40 MM
- AUTOMÁTICO

\$9,500

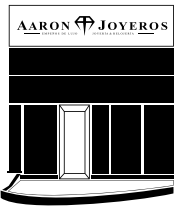

COSTA DEL ESTE

16570

REFERENCIA

EXPLORER II



- ACERO
- 40 MM
- AUTOMÁTICO

\$8,000



OBARRIO

16570

REFERENCIA

EXPLORER II

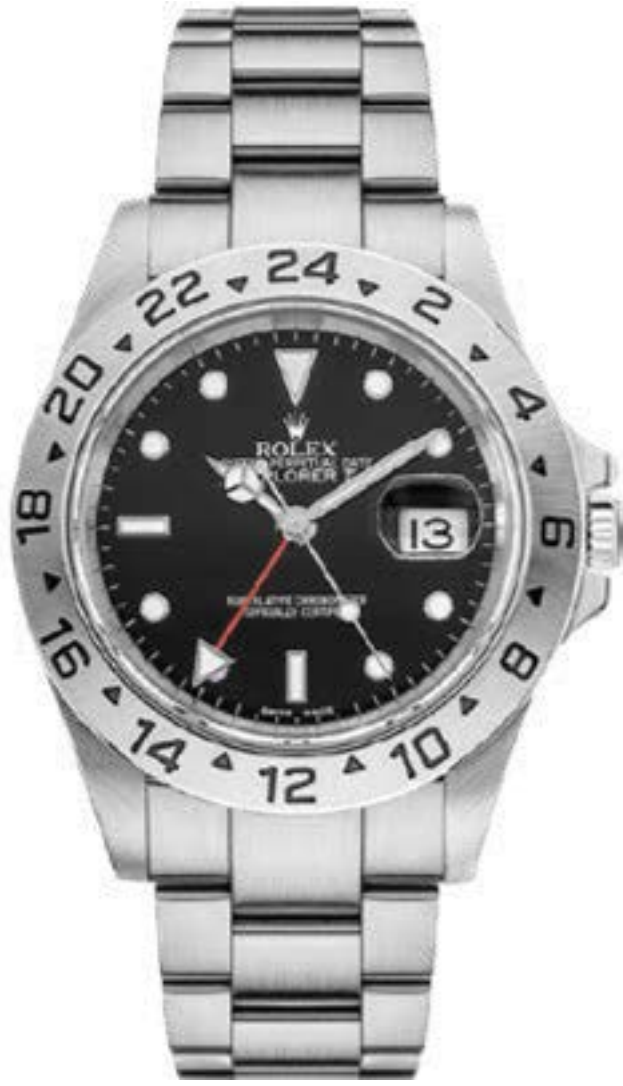

- ACERO
- 40 MM
- AUTOMÁTICO

\$8,000



OBARRIO



CAJA



PAPELES

16570

REFERENCIA

EXPLORER II

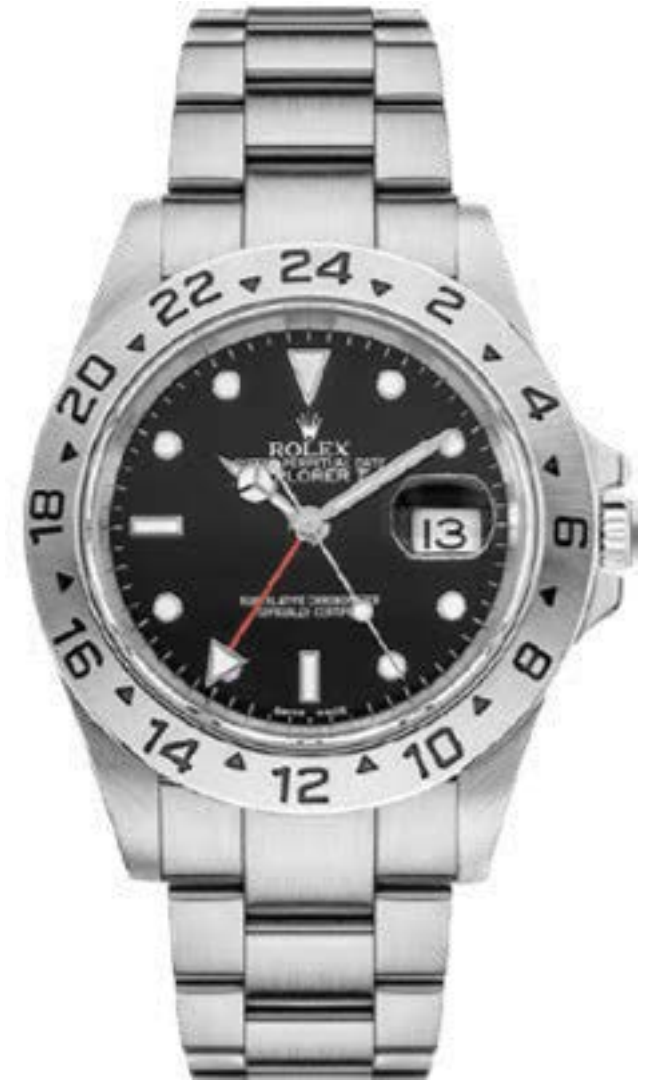

- ACERO
- 40 MM
- AUTOMÁTICO

\$8,000



OBARRIO

16570

REFERENCIA

EXPLORER II

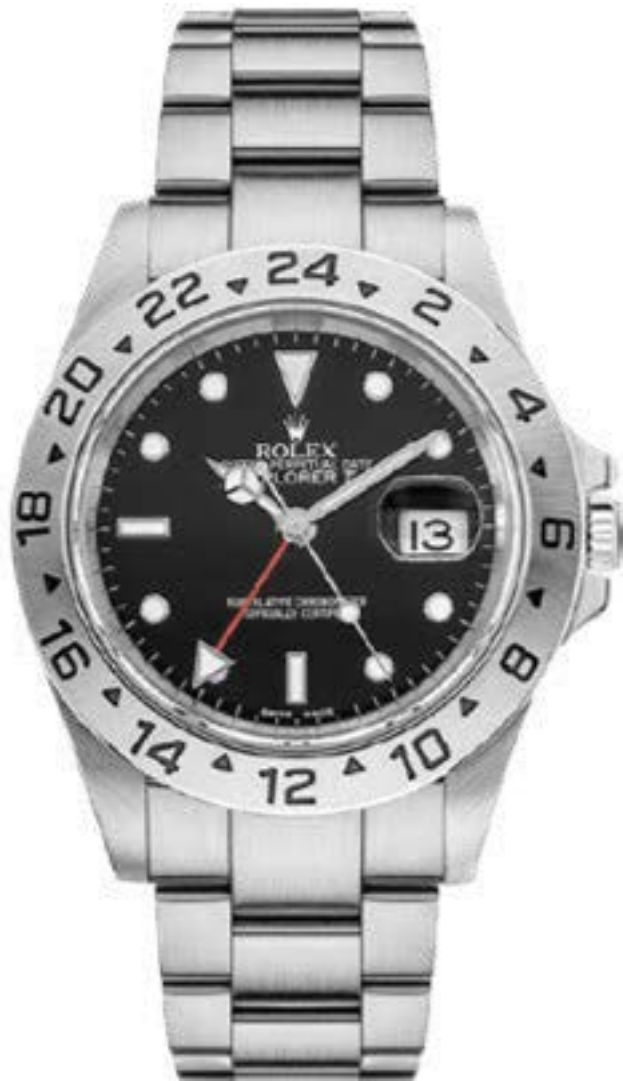

- ACERO
- 40 MM
- AUTOMÁTICO

\$8,000



OBARRIO

16570

REFERENCIA

- AIR KING
- DAYTONA
- DATEJUST
- DAY-DATE
- EXPLORER
- GMT-MASTER
- MILGAUSS
- OYSTER PERP.
- SEA-DWELLER
- SKY-DWELLER
- SUBMARINER
- YACHT-MASTER

EXPLORER II



- ACERO
- 42 MM
- AUTOMÁTICO

\$11,800

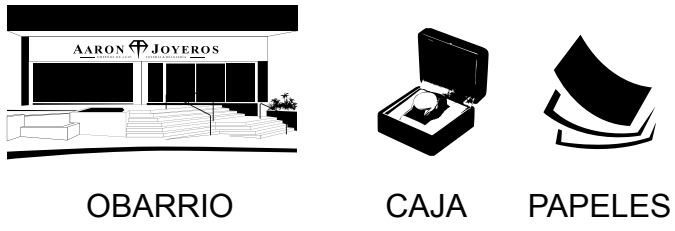

216570
REFERENCIA

EXPLORER II



- ACERO
- 42 MM
- AUTOMÁTICO

\$11,800

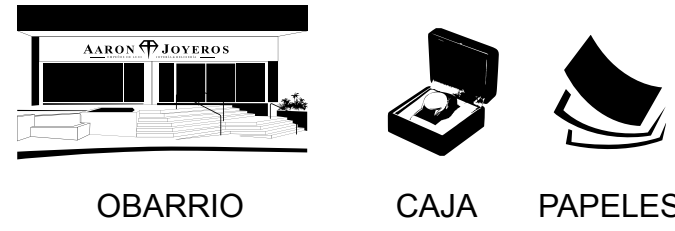

216570
REFERENCIA

EXPLORER II



- ACERO
- 42 MM
- AUTOMÁTICO

\$10,500

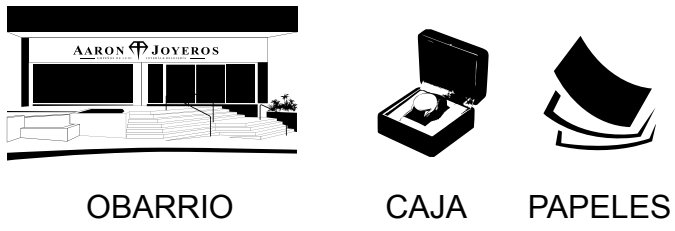

216570
REFERENCIA

EXPLORER II



- ACERO
- 42 MM
- AUTOMÁTICO

\$11,000



216570
REFERENCIA

EXPLORER II



- ACERO
- 42 MM
- AUTOMÁTICO

\$11,000



216570
REFERENCIA

- AIR KING
- DAYTONA
- DATEJUST
- DAY-DATE
- EXPLORER
- GMT-MASTER
- MILGAUSS
- OYSTER PERP.
- SEA-DWELLER
- SKY-DWELLER
- SUBMARINER
- YACHT-MASTER

EXPLORER II



- ACERO / ORO
- 40 MM
- AUTOMÁTICO

\$8,500



OBARRIO

16570

REFERENCIA

EXPLORER II



- ACERO
- 40 MM
- AUTOMÁTICO

\$8,500



OBARRIO

16570

REFERENCIA

EXPLORER II



- ACERO
- 40 MM
- AUTOMÁTICO

\$14,000



OBARRIO

16570

REFERENCIA

EXPLORER II



- ACERO
- 40 MM
- AUTOMÁTICO

\$10,000



OBARRIO



16570

REFERENCIA

- AIR KING
- DAYTONA
- DATEJUST
- DAY-DATE
- EXPLORER
- GMT-MASTER
- MILGAUSS
- OYSTER PERP.
- SEA-DWELLER
- SKY-DWELLER
- SUBMARINER
- YACHT-MASTER

GMT-MASTER II
BATGIRL

"SPYDER DIAL" 

-  ACERO
-  40 MM
-  AUTOMÁTICO

\$10,800

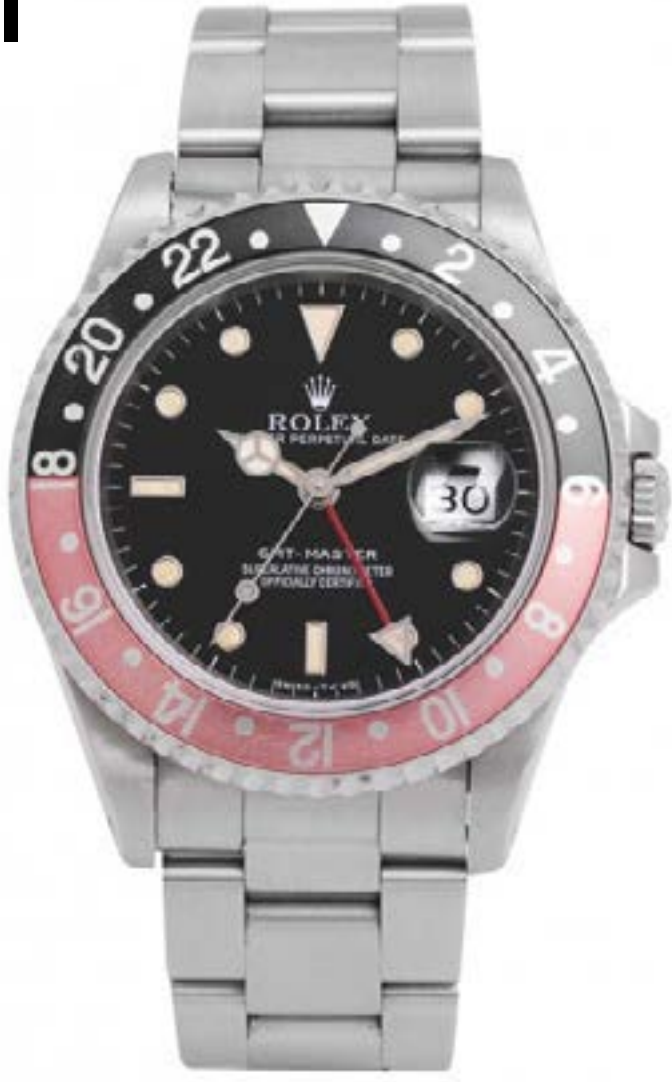



OBARRIO

16700

REFERENCIA

GMT-MASTER II
BRUCE WAYNE

-  ACERO / ORO
-  40 MM
-  AUTOMÁTICO

\$22,000

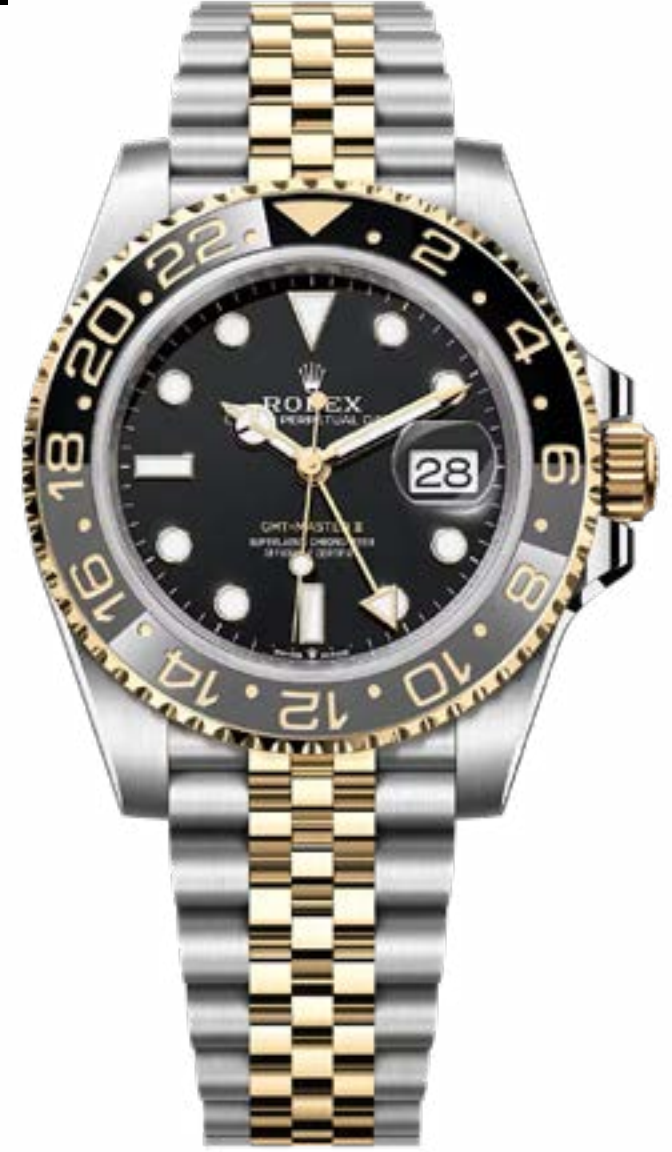



OBARRIO

126713GRN

REFERENCIA

GMT-MASTER II
ROOT BEER

-  ACERO / ORO
-  40 MM
-  AUTOMÁTICO

\$14,800



COSTA DEL ESTE





CAJA

16753

REFERENCIA

GMT-MASTER II
ROOT BEER

-  ORO
-  40 MM
-  AUTOMÁTICO

\$50,000



OBARRIO

1675

REFERENCIA

AIR KING	DAYTONA	DATEJUST	DAY-DATE	EXPLORER	GMT-MASTER
MILGAUSS	OYSTER PERP.	SEA-DWELLER	SKY-DWELLER	SUBMARINER	YACHT-MASTER

GMT-MASTER II
PEPSI

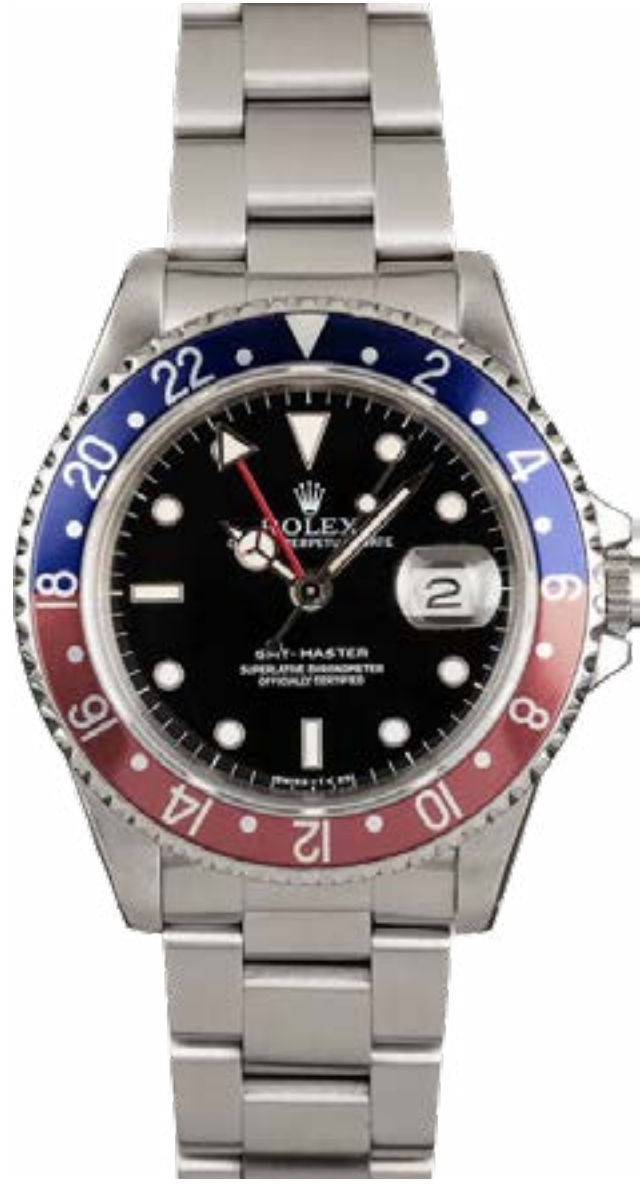

- ACERO
- 40 MM
- AUTOMÁTICO

\$13,000



OBARRIO

16700

REFERENCIA

GMT-MASTER

"NIPLE DIAL"



- ACERO / ORO
- 40 MM
- AUTOMÁTICO

\$10,000



COSTA DEL ESTE

16753

REFERENCIA

GMT-MASTER

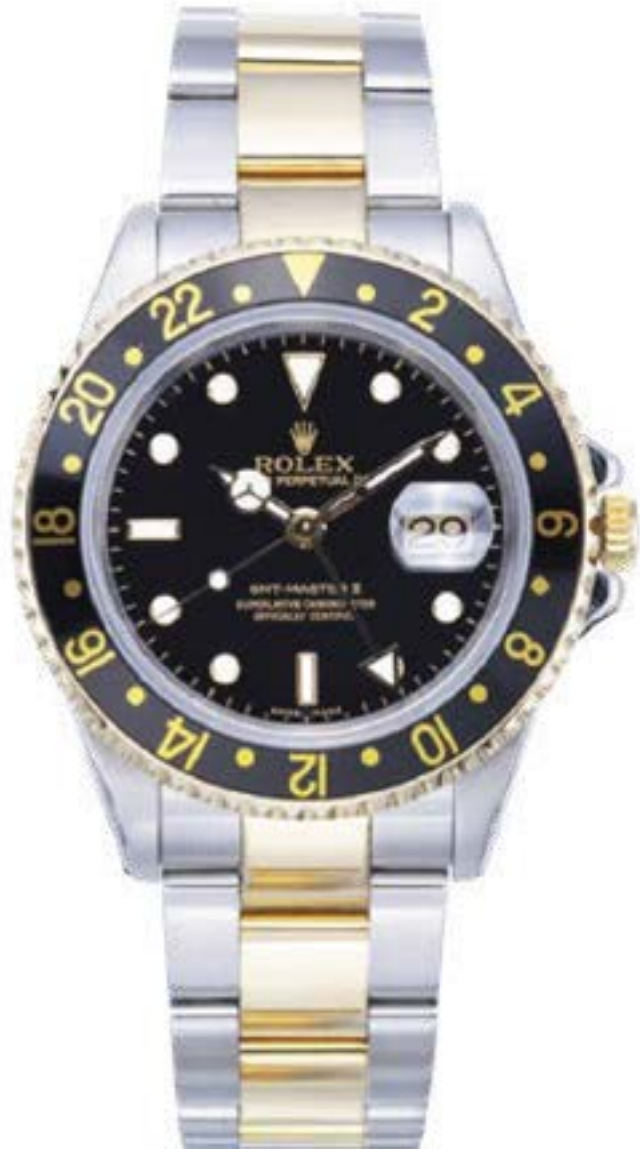

- ACERO / ORO
- 40 MM
- AUTOMÁTICO

\$11,500



OBARRIO

16713

REFERENCIA

GMT-MASTER



- ACERO / ORO
- 40 MM
- AUTOMÁTICO

\$10,500



OBARRIO

1675

REFERENCIA

GMT-MASTER

"NIPLE DIAL"



- ACERO / ORO
- 40 MM
- AUTOMÁTICO

\$9,000



OBARRIO

1675

REFERENCIA

GMT-MASTER



- ACERO / ORO
- 40 MM
- AUTOMÁTICO

\$10,800



OBARRIO

16753

REFERENCIA

AIR KING

DAYTONA

DATEJUST

DAY-DATE

EXPLORER

GMT-MASTER

MILGAUSS

OYSTER PERP.

SEA-DWELLER

SKY-DWELLER

SUBMARINER

YACHT-MASTER

GMT-MASTER II



ACERO

40 MM

AUTOMÁTICO

\$13,000



COSTA DEL ESTE

116710LN

REFERENCIA



AIR KING

DAYTONA

DATEJUST

DAY-DATE

EXPLORER

GMT-MASTER

MILGAUSS

OYSTER PERP.

SEA-DWELLER

SKY-DWELLER

SUBMARINER

YACHT-MASTER

MILGAUSS

OYSTER PERPETUAL

ACERO

40 MM

AUTOMÁTICO

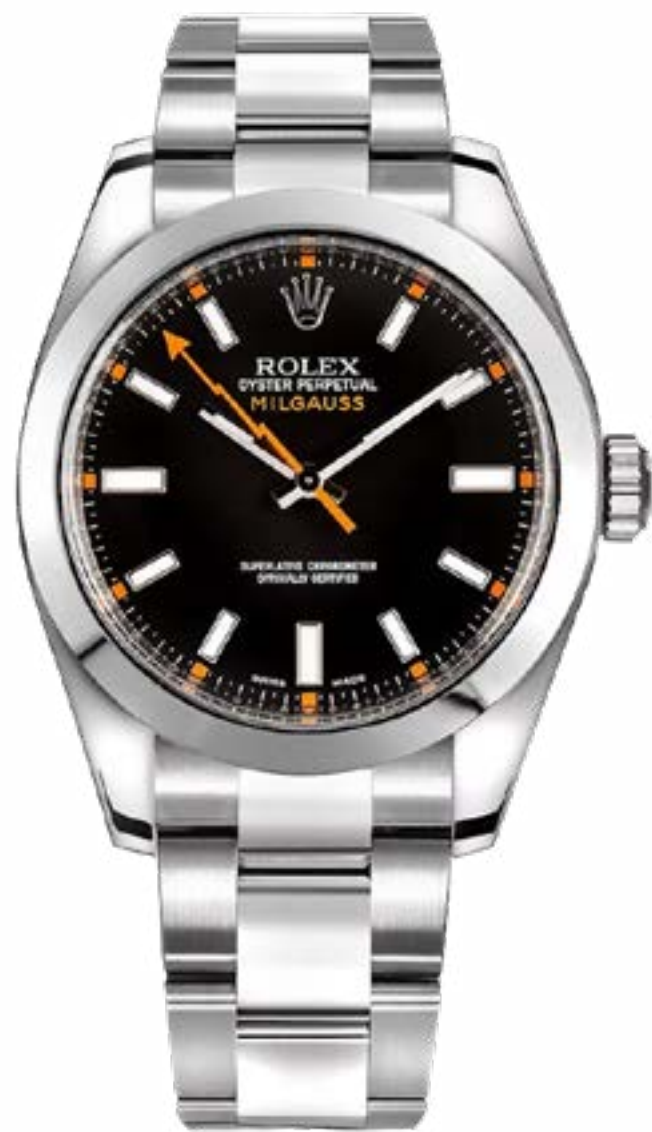

\$9,800



OBARRIO

116400

REFERENCIA

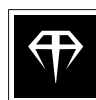

- AIR KING
- DAYTONA
- DATEJUST
- DAY-DATE
- EXPLORER
- GMT-MASTER
- MILGAUSS
- OYSTER PERP.
- SEA-DWELLER
- SKY-DWELLER
- SUBMARINER
- YACHT-MASTER

OYSTER PERPETUAL



- ACERO / ORO
- 26 MM
- AUTOMÁTICO

\$4,000



OBARRIO

6917

REFERENCIA

OYSTER PERPETUAL
CORAL RED



- ACERO
- 31 MM
- AUTOMÁTICO

\$11,000



OBARRIO



PAPELES

277200

REFERENCIA

OYSTER PERPETUAL



"TIFFANY DIAL"

- ACERO
- 31 MM
- AUTOMÁTICO

\$12,500



OBARRIO



CAJA



PAPELES

277200

REFERENCIA

OYSTER PERPETUAL
"DÓMINOS PIZZA"



"NUEVO A ESTRENAR"

- ACERO
- 36 MM
- AUTOMÁTICO

\$9,000



OBARRIO



CAJA



PAPELES

116000

REFERENCIA

OYSTER PERPETUAL



"NUEVO A ESTRENAR"

- ACERO
- 41 MM
- AUTOMÁTICO

\$12,500



OBARRIO



CAJA



PAPELES

0000

REFERENCIA

AIR KING

DAYTONA

DATEJUST

DAY-DATE

EXPLORER

GMT-MASTER

MILGAUSS

OYSTER PERP.

SEA-DWELLER

SKY-DWELLER

SUBMARINER

YACHT-MASTER

OYSTER PERPETUAL



- ORO
- 24 MM
- AUTOMÁTICO

\$9,500



OBARRIO



CAJA

6617

REFERENCIA

OYSTER PERPETUAL



- ORO
- 34 MM
- AUTOMÁTICO

\$11,500



OBARRIO

100S

REFERENCIA

OYSTER PERPETUAL



- ORO
- 31 MM
- CUERDA MANUAL

\$8,600



COSTA DEL ESTE

6619

REFERENCIA

**OYSTER PERPETUAL
DATE**



- ACERO / ORO
- 25 MM
- AUTOMÁTICO

\$4,000



OBARRIO

6517

REFERENCIA

- AIR KING
- DAYTONA
- DATEJUST
- DAY-DATE
- EXPLORER
- GMT-MASTER
- MILGAUSS
- OYSTER PERP.
- SEA-DWELLER
- SKY-DWELLER
- SUBMARINER
- YACHT-MASTER

SEA-DWELLER



- ACERO
- 44 MM
- AUTOMÁTICO

\$17,500



OBARRIO



CAJA



PAPELES

136660

REFERENCIA

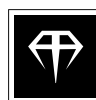

SEA-DWELLER



- ACERO
- 40 MM
- AUTOMÁTICO

\$9,250



COSTA DEL ESTE

16600

REFERENCIA

SEA-DWELLER

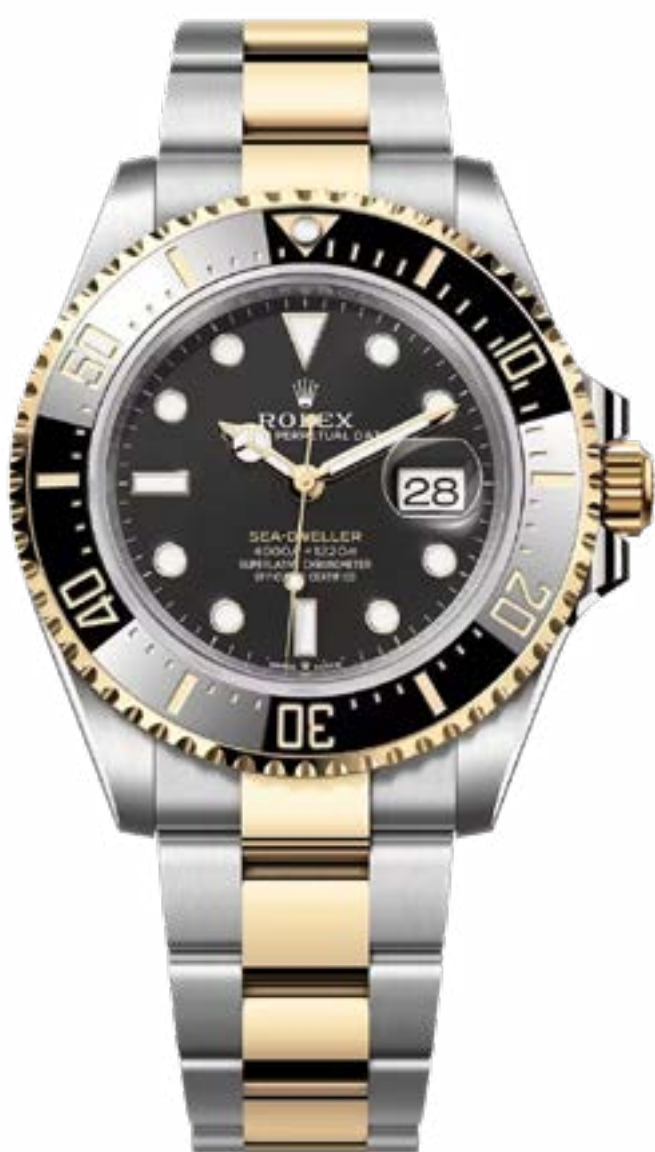

- ACERO / ORO
- 43 MM
- AUTOMÁTICO

\$23,000



OBARRIO



CAJA



PAPELES

126603

REFERENCIA



- AIR KING
- DAYTONA
- DATEJUST
- DAY-DATE
- EXPLORER
- GMT-MASTER
- MILGAUSS
- OYSTER PERP.
- SEA-DWELLER
- SKY-DWELLER
- SUBMARINER
- YACHT-MASTER

SKY-DWELLER



- ACERO / ORO
- 42 MM
- AUTOMÁTICO

\$22,500

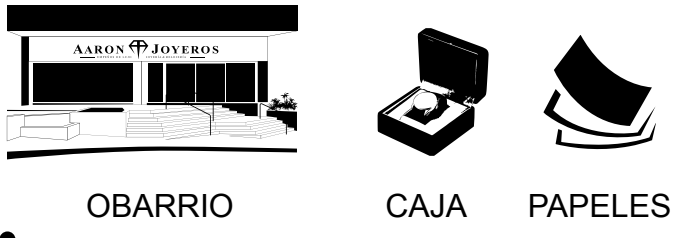

326933

REFERENCIA

SKY-DWELLER



- ORO ROSA
- 42 MM
- AUTOMÁTICO

\$45,000

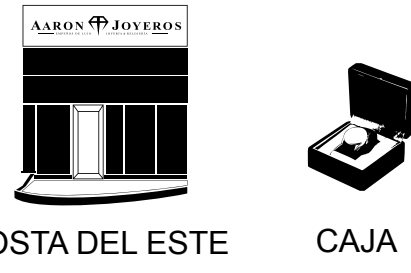

326935

REFERENCIA

SKY-DWELLER



- ACERO / ORO
- 42 MM
- AUTOMÁTICO

\$22,800

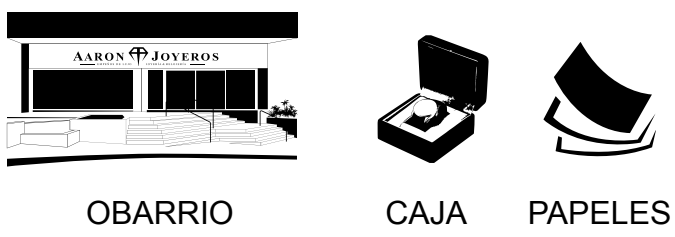

336933

REFERENCIA

AIR KING

DAYTONA

DATEJUST

DAY-DATE

EXPLORER

GMT-MASTER

MILGAUSS

OYSTER PERP.

SEA-DWELLER

SKY-DWELLER

SUBMARINER

YACHT-MASTER

SUBMARINER
STARBUCKS

"NUEVO A ESTRENAR"

- ACERO
- 40 MM
- AUTOMÁTICO



\$17,800



OBARRIO



CAJA



PAPELES

126610LV

REFERENCIA

SUBMARINER
STARBUCKS

- ACERO
- 40 MM
- AUTOMÁTICO



\$17,000



OBARRIO



CAJA



PAPELES

126610LV

REFERENCIA

SUBMARINER
KERMIT

"50 ANIVERSARIO"

- ACERO
- 40 MM
- AUTOMÁTICO



\$12,500



OBARRIO

16610LV

REFERENCIA

SUBMARINER
KERMIT

"50 ANIVERSARIO"

- ACERO
- 40 MM
- AUTOMÁTICO



\$12,500



COSTA DEL ESTE



CAJA

16610LV

REFERENCIA

SUBMARINER
KERMIT

- ACERO
- 40 MM
- AUTOMÁTICO



\$12,000



OBARRIO

16610LV

REFERENCIA

SUBMARINER
KERMIT

- ACERO
- 40 MM
- AUTOMÁTICO



\$12,500



OBARRIO



CAJA

16610LV

REFERENCIA

- AIR KING
- DAYTONA
- DATEJUST
- DAY-DATE
- EXPLORER
- GMT-MASTER
- MILGAUSS
- OYSTER PERP.
- SEA-DWELLER
- SKY-DWELLER
- SUBMARINER
- YACHT-MASTER

SUBMARINER



- ACERO / ORO
- 40 MM
- AUTOMÁTICO

\$12,500



OBARRIO

16613

REFERENCIA

SUBMARINER



- ACERO / ORO
- 40 MM
- AUTOMÁTICO

\$13,000



OBARRIO



CAJA

16613

REFERENCIA

SUBMARINER



- ACERO / ORO
- 40 MM
- AUTOMÁTICO

\$15,500



OBARRIO

116613

REFERENCIA

SUBMARINER



- ACERO / ORO
- 40 MM
- AUTOMÁTICO

\$13,000



OBARRIO



CAJA

16613

REFERENCIA

SUBMARINER



- ACERO / ORO
- 40 MM
- AUTOMÁTICO

\$12,500



OBARRIO

16613

REFERENCIA

SUBMARINER



- ACERO / ORO
- 40 MM
- AUTOMÁTICO

\$11,000



OBARRIO

16803

REFERENCIA

- AIR KING
- DAYTONA
- DATEJUST
- DAY-DATE
- EXPLORER
- GMT-MASTER
- MILGAUSS
- OYSTER PERP.
- SEA-DWELLER
- SKY-DWELLER
- SUBMARINER
- YACHT-MASTER

SUBMARINER



- ACERO / ORO
- 40 MM
- AUTOMÁTICO

\$13,000



COSTA DEL ESTE

16613

REFERENCIA

SUBMARINER



- ACERO / ORO
- 41 MM
- AUTOMÁTICO

\$21,500



OBARRIO



CAJA



PAPELES

126613

REFERENCIA

SUBMARINER



- ACERO / ORO
- 40 MM
- AUTOMÁTICO

\$12,500



OBARRIO

16613

REFERENCIA

SUBMARINER



- ACERO / ORO
- 40 MM
- AUTOMÁTICO

\$12,500



OBARRIO



CAJA



PAPELES

16613

REFERENCIA

SUBMARINER



- ACERO / ORO
- 40 MM
- AUTOMÁTICO

\$13,000



COSTA DEL ESTE

16613

REFERENCIA

SUBMARINER



- ACERO / ORO
- 40 MM
- AUTOMÁTICO

\$16,500



OBARRIO



CAJA



PAPELES

116613

REFERENCIA

AIR KING

DAYTONA

DATEJUST

DAY-DATE

EXPLORER

GMT-MASTER

MILGAUSS

OYSTER PERP.

SEA-DWELLER

SKY-DWELLER

SUBMARINER

YACHT-MASTER

SUBMARINER



ACERO / ORO

40 MM

AUTOMÁTICO

\$21,500



OBARRIO



CAJA



PAPELES

126613LB

REFERENCIA



- AIR KING
- DAYTONA
- DATEJUST
- DAY-DATE
- EXPLORER
- GMT-MASTER
- MILGAUSS
- OYSTER PERP.
- SEA-DWELLER
- SKY-DWELLER
- SUBMARINER
- YACHT-MASTER

SUBMARINER



- ORO
- 40 MM
- AUTOMÁTICO

\$30,500

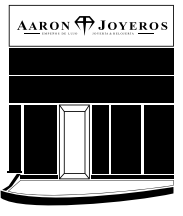

COSTA DEL ESTE

16618T
REFERENCIA

**SUBMARINER
SMURF"**



- ORO BLANCO
- 40 MM
- AUTOMÁTICO

\$38,500



OBARRIO



CAJA



PAPELES

116619
REFERENCIA

SUBMARINER



- ACERO / ORO
- 40 MM
- AUTOMÁTICO

\$38,000



OBARRIO



CAJA



PAPELES

116618LN
REFERENCIA

SUBMARINER

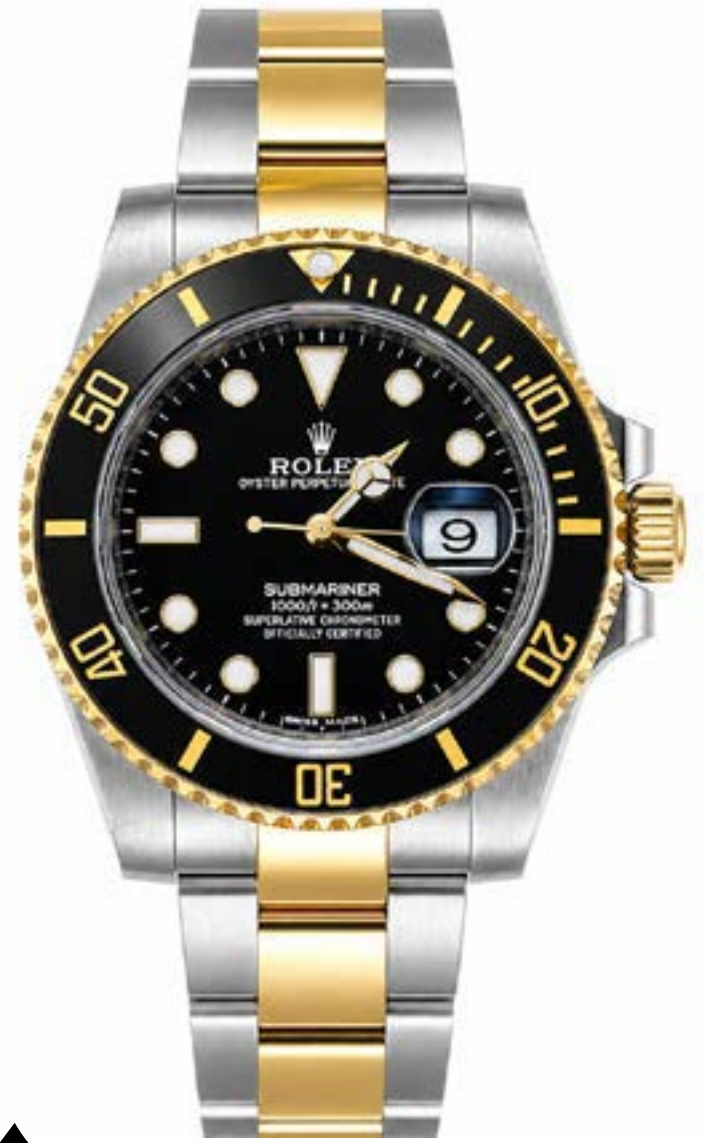

- ACERO / ORO
- 40 MM
- AUTOMÁTICO

\$16,500



OBARRIO



CAJA



PAPELES

116613
REFERENCIA

SUBMARINER

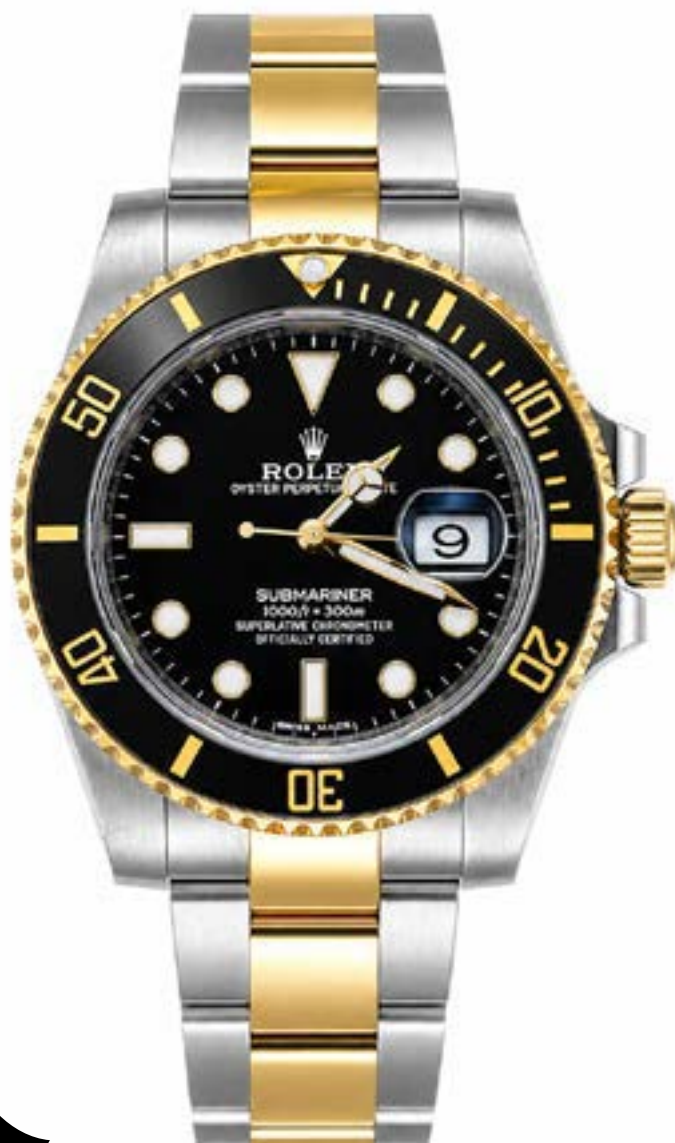

- ACERO / ORO
- 40 MM
- AUTOMÁTICO

\$16,500



OBARRIO



CAJA



PAPELES

116613
REFERENCIA



ROLEX

SUBMARINER

NO DATE

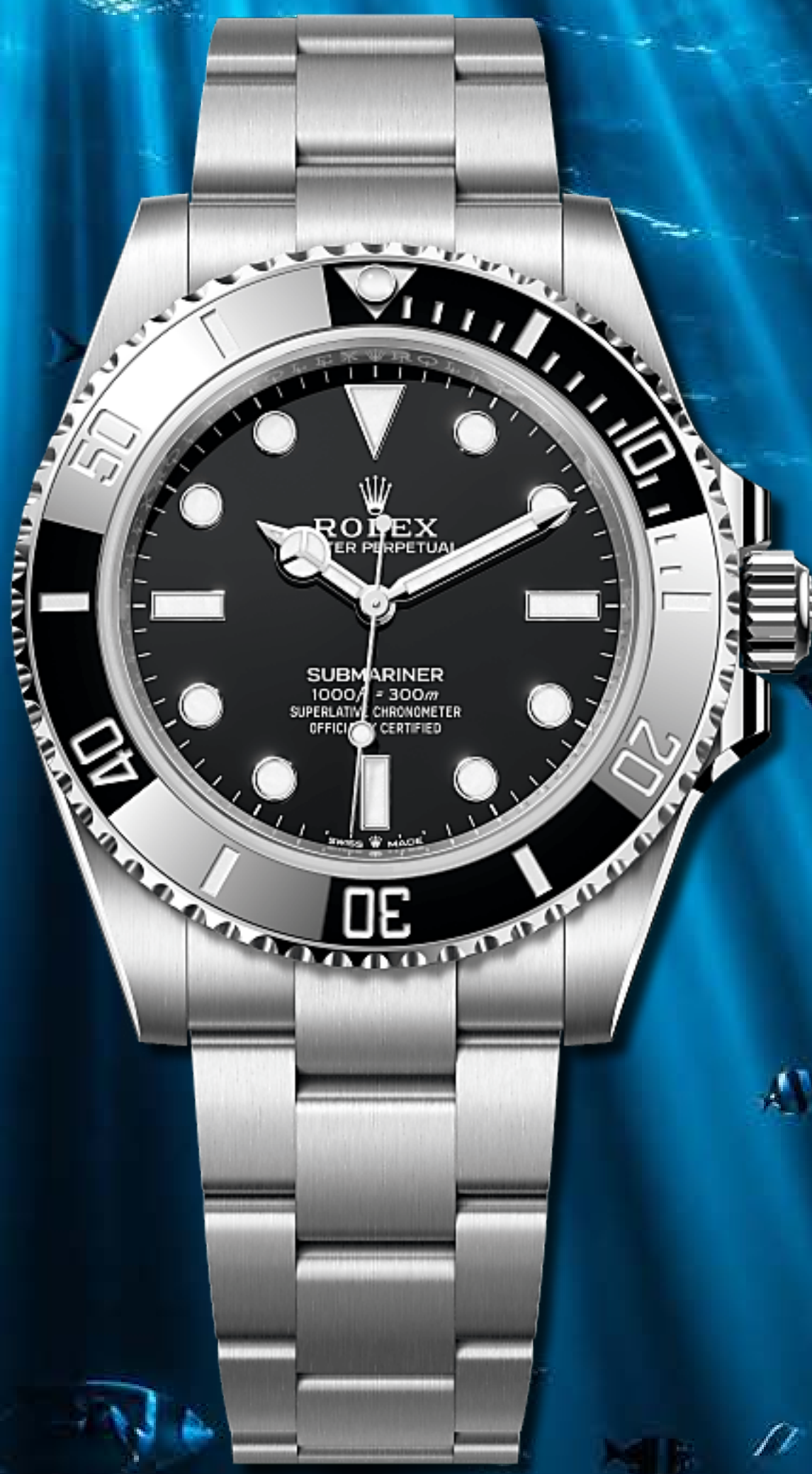

ACERO



40 MM



AUTOMÁTICO

\$14,800



OBARRIO



CAJA



PAPELES

124060

REFERENCIA

- AIR KING
- DAYTONA
- DATEJUST
- DAY-DATE
- EXPLORER
- GMT-MASTER
- MILGAUSS
- OYSTER PERP.
- SEA-DWELLER
- SKY-DWELLER
- SUBMARINER
- YACHT-MASTER

**SUBMARINER
DATE**

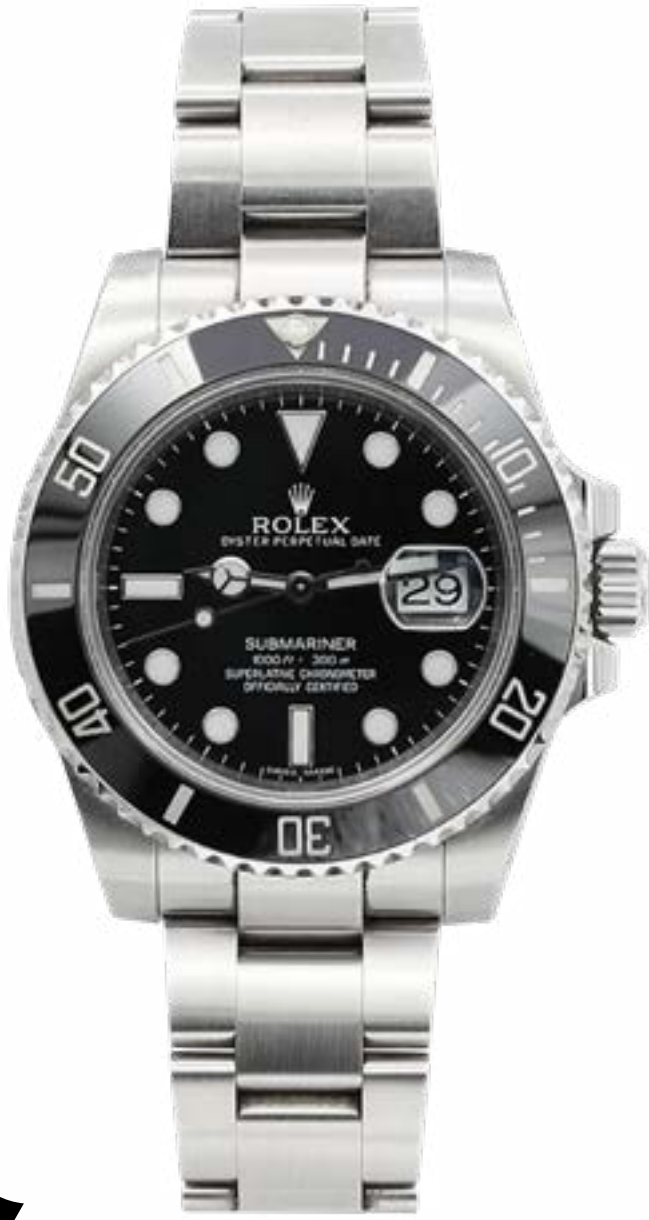

- ACERO
- 40 MM
- AUTOMÁTICO

\$13,500

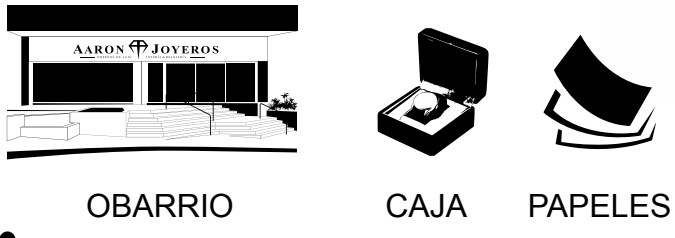

116610
REFERENCIA

**SUBMARINER
DATE**

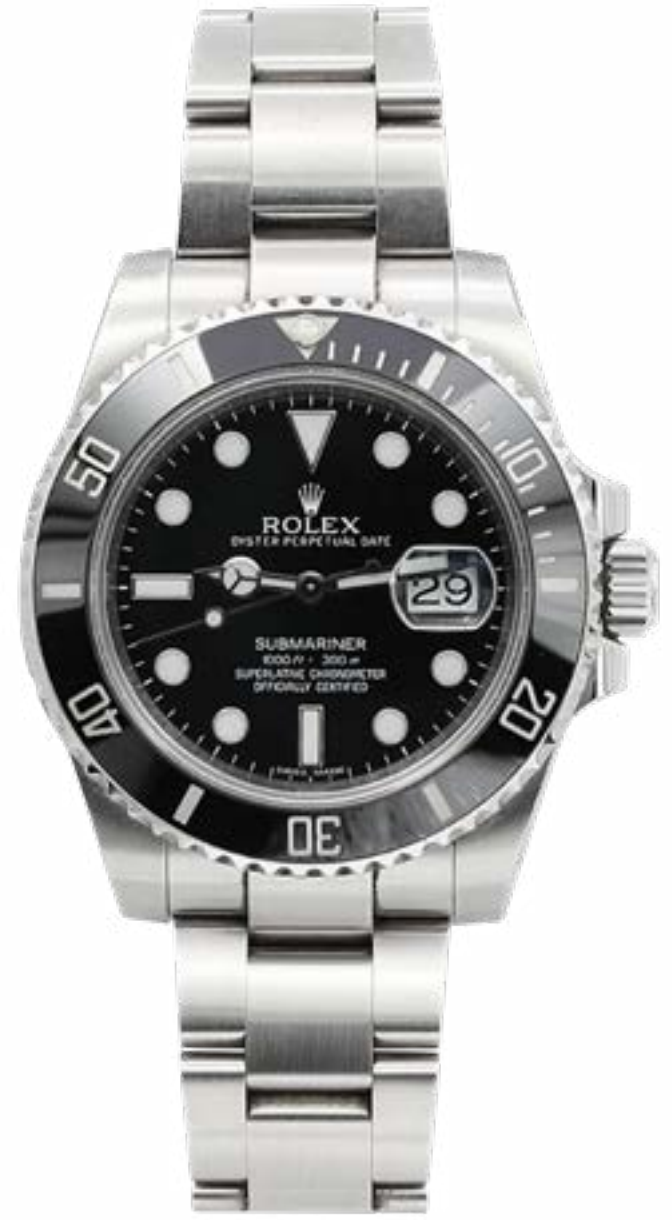

- ACERO
- 40 MM
- AUTOMÁTICO

\$13,000



116610
REFERENCIA

**SUBMARINER
DATE**



- ACERO
- 40 MM
- AUTOMÁTICO

\$9,800



16610
REFERENCIA

**SUBMARINER
DATE**



- ACERO
- 40 MM
- AUTOMÁTICO

\$10,000



16610
REFERENCIA

**SUBMARINER
DATE**

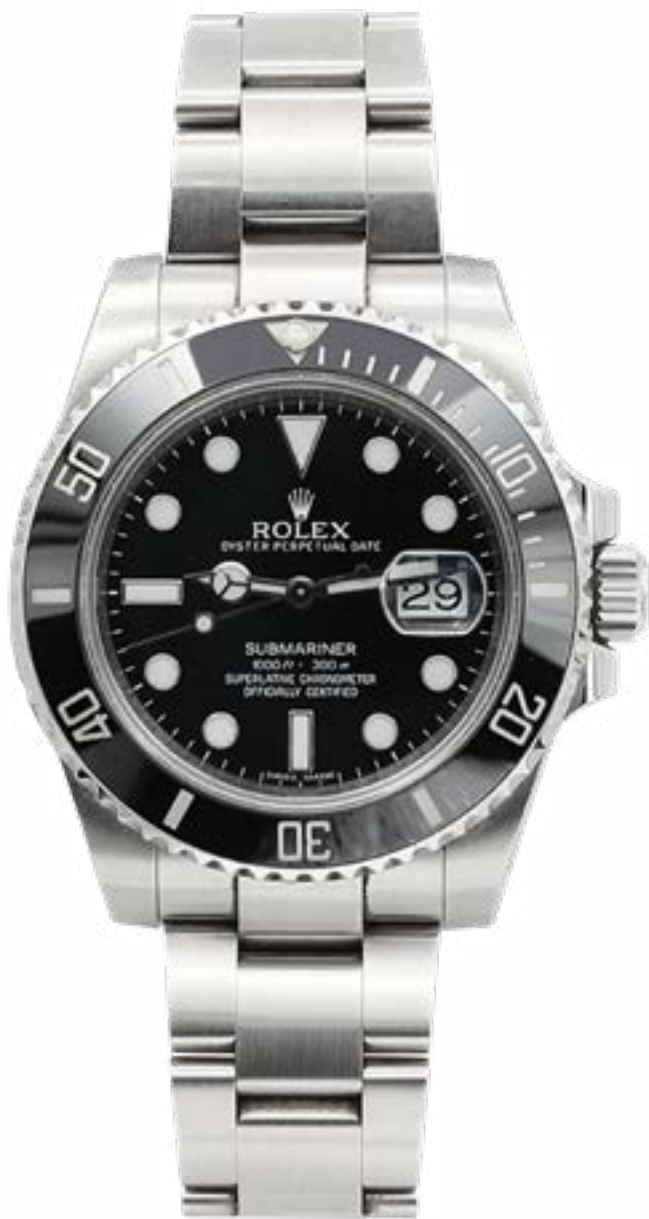

- ACERO
- 40 MM
- AUTOMÁTICO

\$9,700



16610
REFERENCIA

**SUBMARINER
DATE**

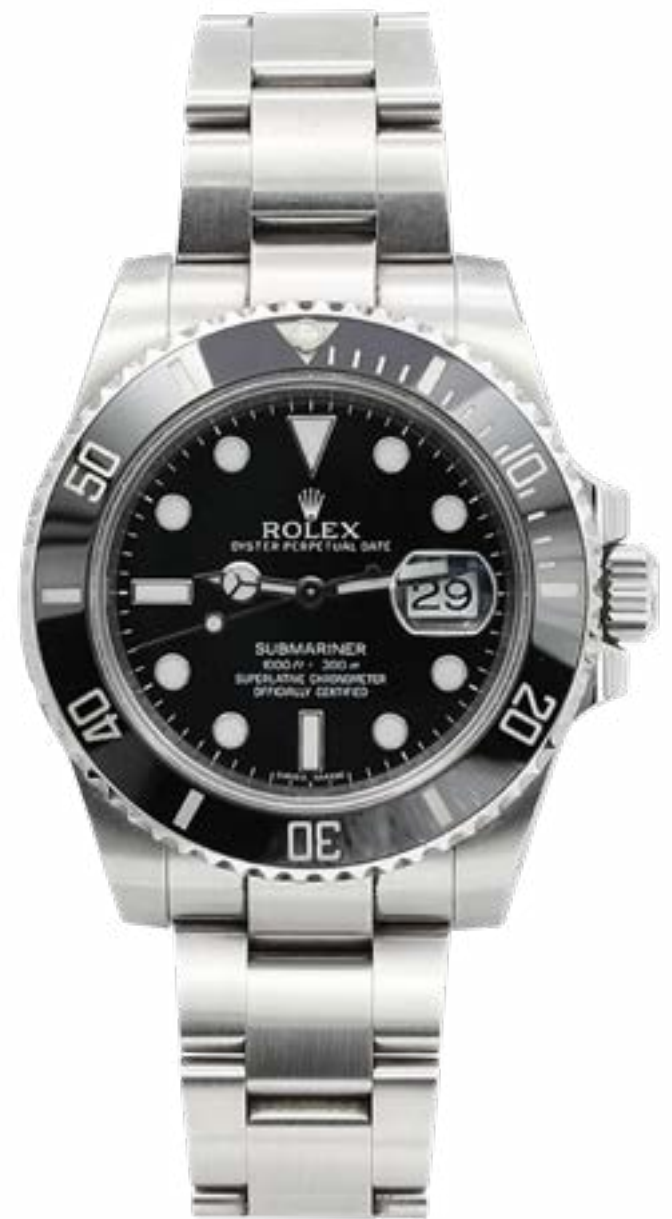

- ACERO
- 40 MM
- AUTOMÁTICO

\$9,600



16610
REFERENCIA

- AIR KING
- DAYTONA
- DATEJUST
- DAY-DATE
- EXPLORER
- GMT-MASTER
- MILGAUSS
- OYSTER PERP.
- SEA-DWELLER
- SKY-DWELLER
- SUBMARINER
- YACHT-MASTER

SUBMARINER DATE



- ACERO
- 40 MM
- AUTOMÁTICO

\$10,000

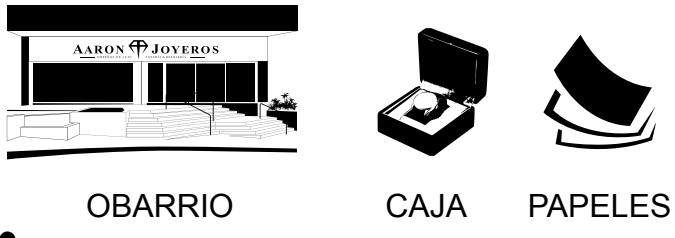

16610
REFERENCIA

SUBMARINER DATE



- ACERO
- 40 MM
- AUTOMÁTICO

\$10,000



16610T
REFERENCIA

SUBMARINER DATE

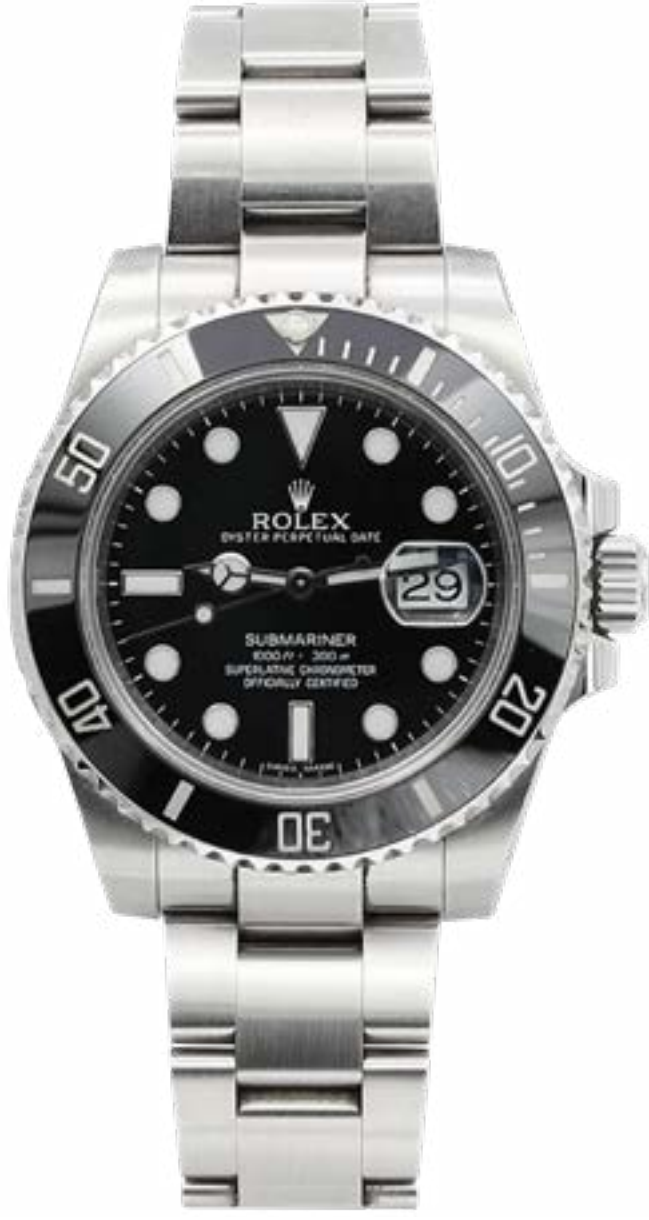

- ACERO
- 40 MM
- AUTOMÁTICO

\$10,000



16610
REFERENCIA

SUBMARINER DATE



- ACERO
- 40 MM
- AUTOMÁTICO

\$10,000



16610
REFERENCIA

SUBMARINER DATE



- ACERO
- 40 MM
- AUTOMÁTICO

\$16,500



1680
REFERENCIA

SUBMARINER DATE



- ACERO
- 40 MM
- AUTOMÁTICO

\$12,000



116610
REFERENCIA

- AIR KING
- DAYTONA
- DATEJUST
- DAY-DATE
- EXPLORER
- GMT-MASTER
- MILGAUSS
- OYSTER PERP.
- SEA-DWELLER
- SKY-DWELLER
- SUBMARINER
- YACHT-MASTER

**SUBMARINER
DATE**

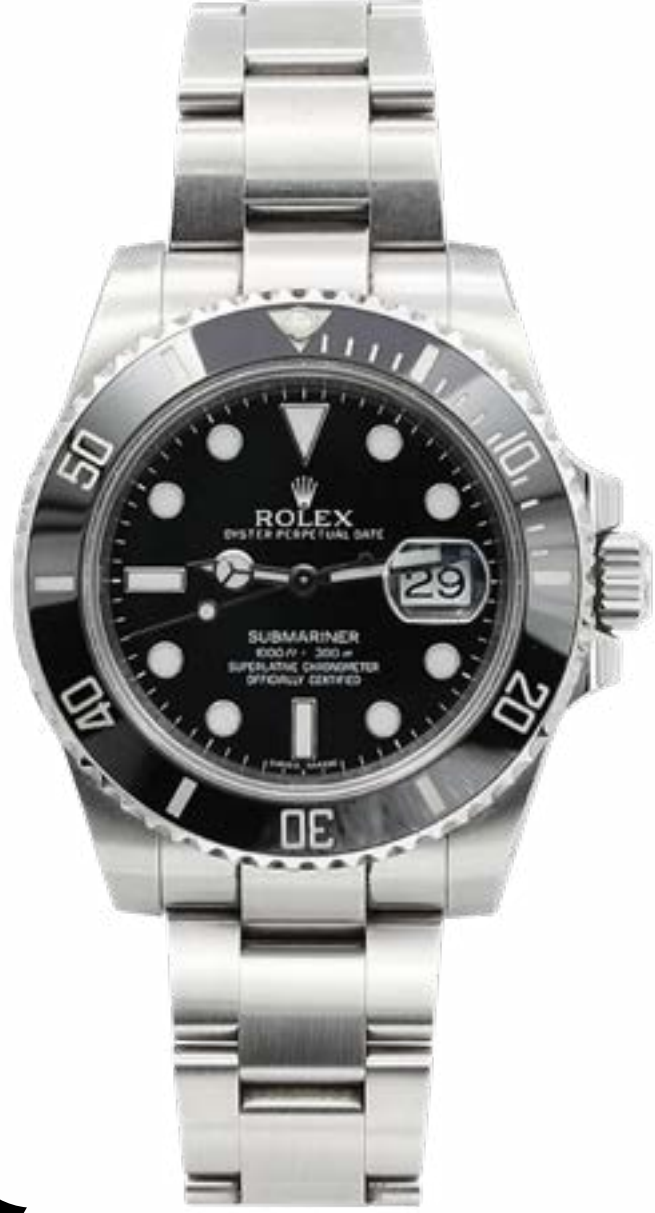

- ACERO
- 40 MM
- AUTOMÁTICO

\$15,000

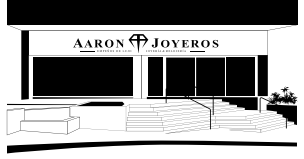

OBARRIO



CAJA



PAPELES

126610

REFERENCIA

**SUBMARINER
DATE**



- ACERO
- 40 MM
- AUTOMÁTICO

\$12,800



OBARRIO

1680

REFERENCIA

- AIR KING
- DAYTONA
- DATEJUST
- DAY-DATE
- EXPLORER
- GMT-MASTER
- MILGAUSS
- OYSTER PERP.
- SEA-DWELLER
- SKY-DWELLER
- SUBMARINER
- YACHT-MASTER

SUBMARINER
NO DATE

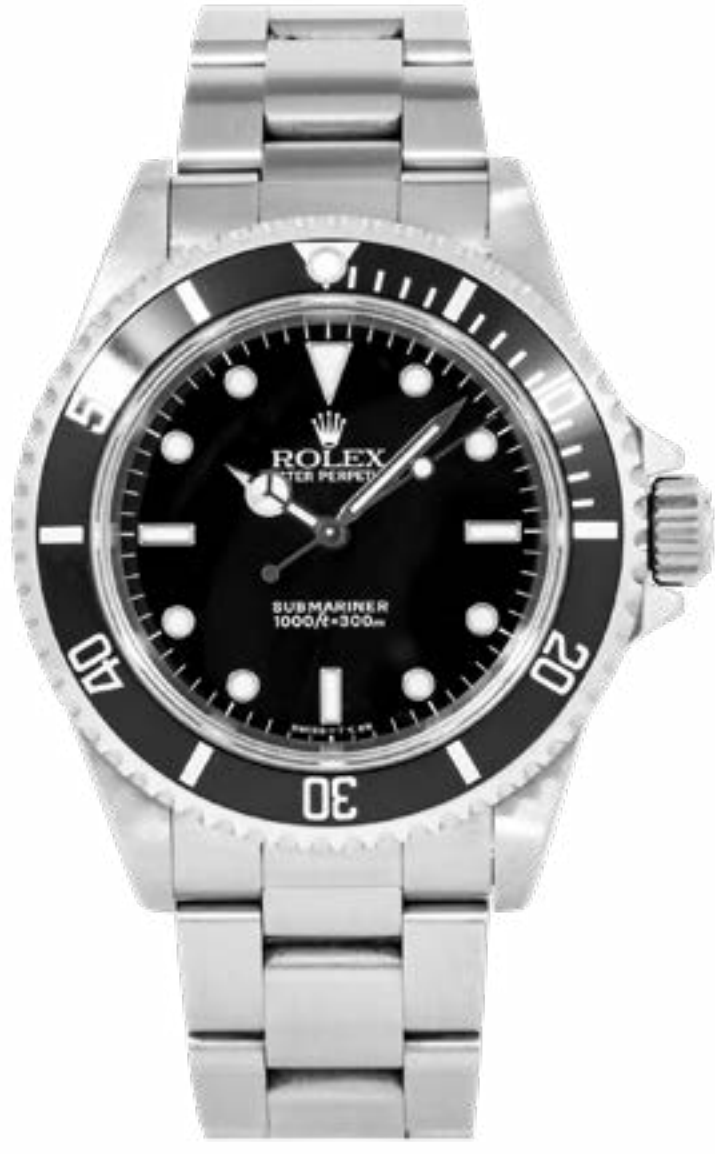

- ACERO
- 40 MM
- AUTOMÁTICO

\$8,500



OBARRIO

14060

REFERENCIA

SUBMARINER
NO DATE

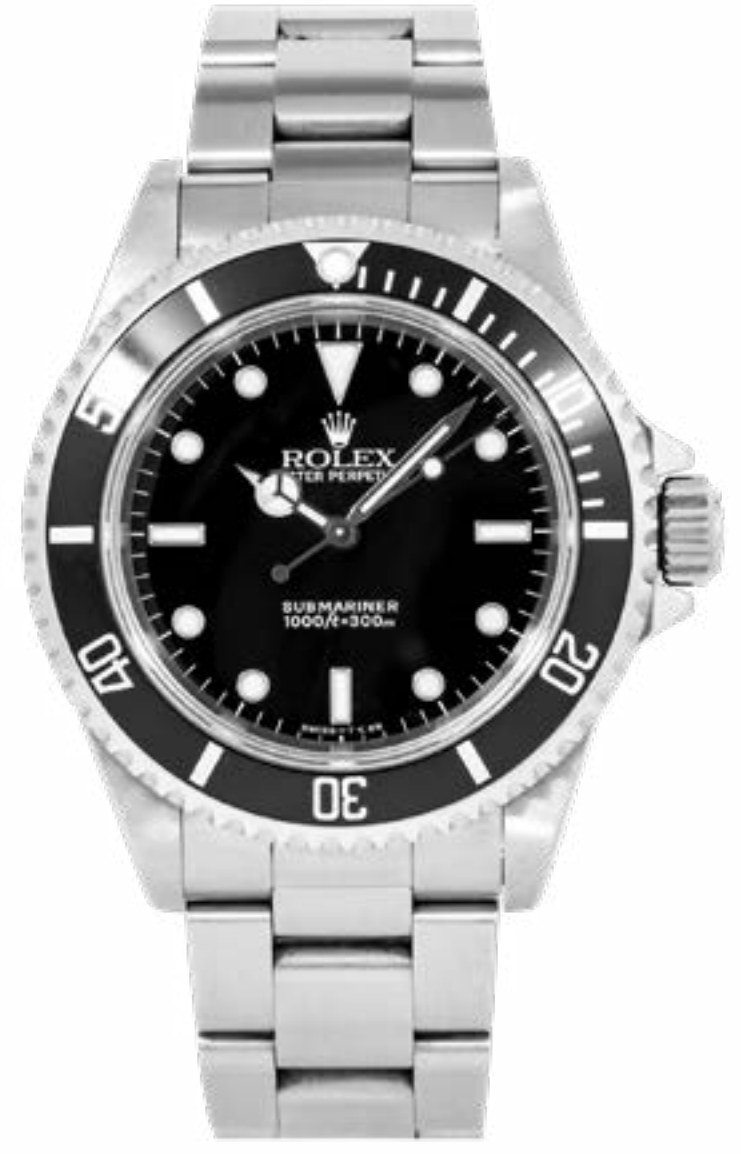

- ACERO
- 40 MM
- AUTOMÁTICO

\$10,000



OBARRIO

14060M

REFERENCIA

SUBMARINER
NO DATE



- ACERO
- 40 MM
- AUTOMÁTICO

\$13,000



OBARRIO

5512

REFERENCIA

SUBMARINER
NO DATE



- ACERO
- 40 MM
- AUTOMÁTICO

\$15,000



OBARRIO

114060

REFERENCIA

SUBMARINER
NO DATE



- ACERO
- 40 MM
- AUTOMÁTICO

\$16,000



OBARRIO

5513

REFERENCIA

SUBMARINER
NO DATE



- ACERO
- 40 MM
- AUTOMÁTICO

\$14,800



OBARRIO

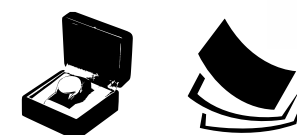

CAJA

PAPELES

124060

REFERENCIA

- AIR KING
- DAYTONA
- DATEJUST
- DAY-DATE
- EXPLORER
- GMT-MASTER
- MILGAUSS
- OYSTER PERP.
- SEA-DWELLER
- SKY-DWELLER
- SUBMARINER
- YACHT-MASTER

SUBMARINER
NO DATE



- ACERO
- 40 MM
- AUTOMÁTICO

\$15,000

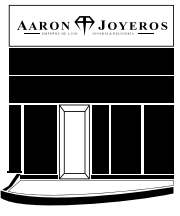

COSTA DEL ESTE

5513

REFERENCIA

SUBMARINER
NO DATE



- ACERO
- 40 MM
- AUTOMÁTICO

\$10,000



COSTA DEL ESTE

5513

REFERENCIA

SUBMARINER
NO DATE

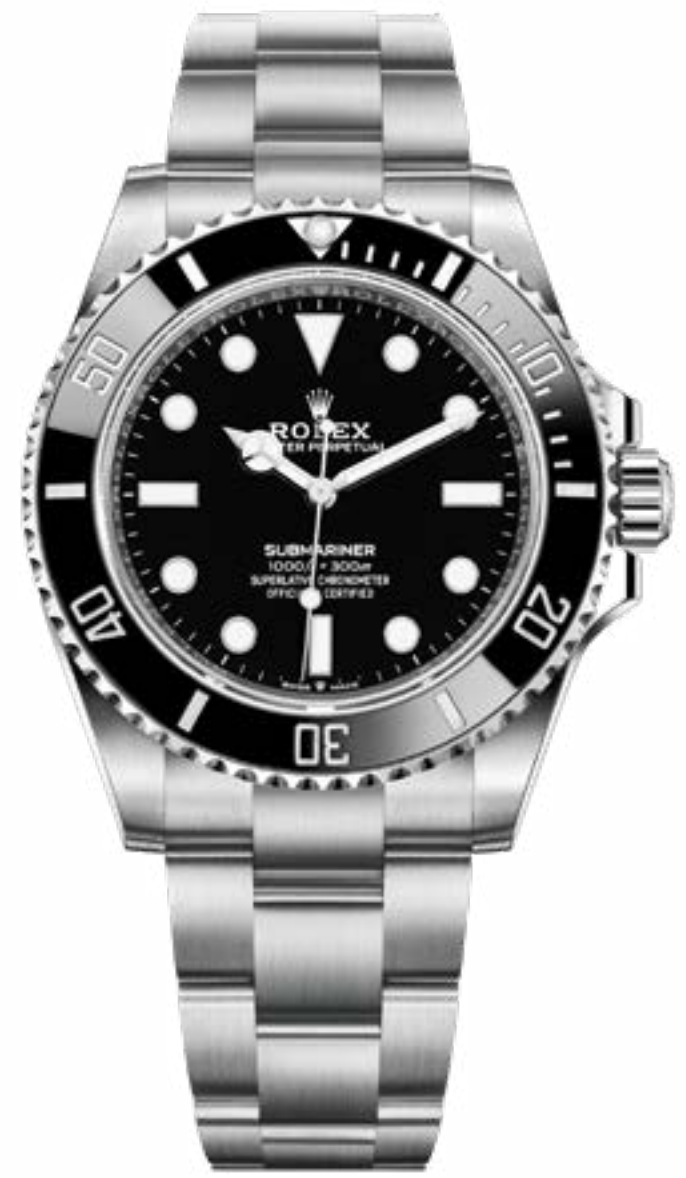

"NUEVO A ESTRENAR"

- ACERO
- 40 MM
- AUTOMÁTICO

\$15,300



OBARRIO



CAJA



PAPELES

124060

REFERENCIA

YACHT-MASTER

“TAHITIAN DIAL”

ROLEX



16628

REFERENCIA



ORO



40 MM



AUTOMÁTICO

\$35,000



CAJA



PAPELES



OBARRIO

AARON  JOYEROS

— JOYERIA & RELOJERIA —

- AIR KING
- DAYTONA
- DATEJUST
- DAY-DATE
- EXPLORER
- GMT-MASTER
- MILGAUSS
- OYSTER PERP.
- SEA-DWELLER
- SKY-DWELLER
- SUBMARINER
- YACHT-MASTER

YACHT-MASTER

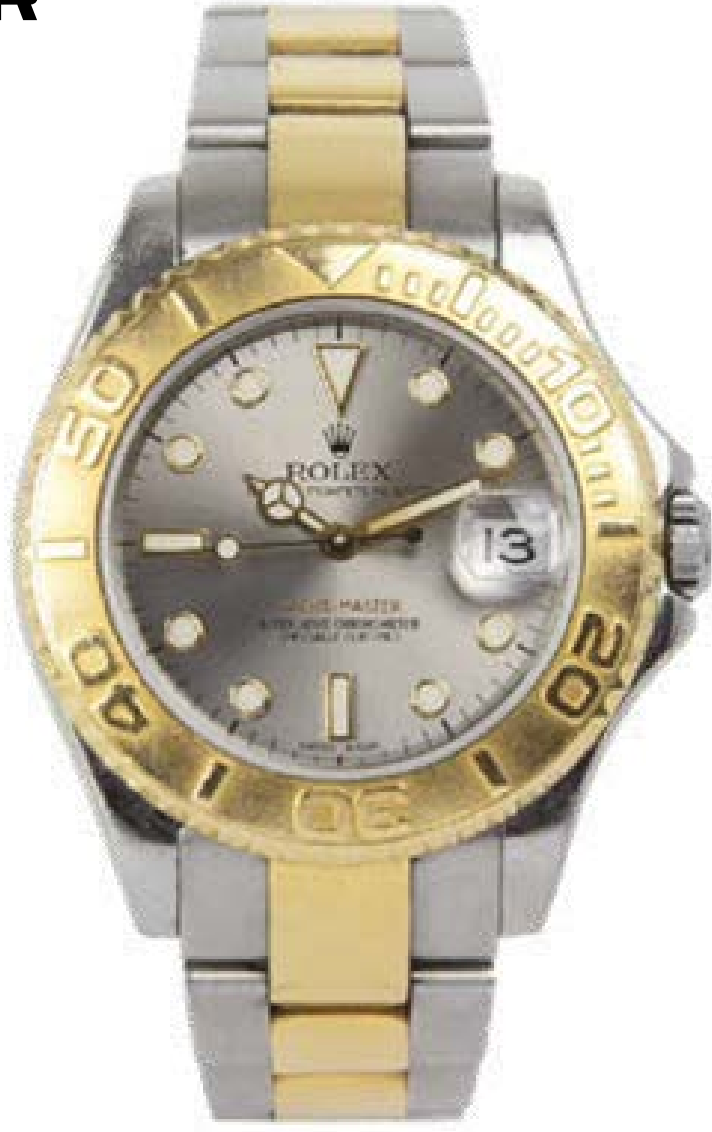

- ACERO / ORO
- 40 MM
- AUTOMÁTICO

\$13,800

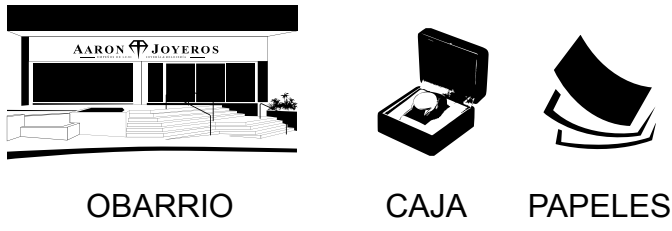

168623
REFERENCIA

YACHT-MASTER

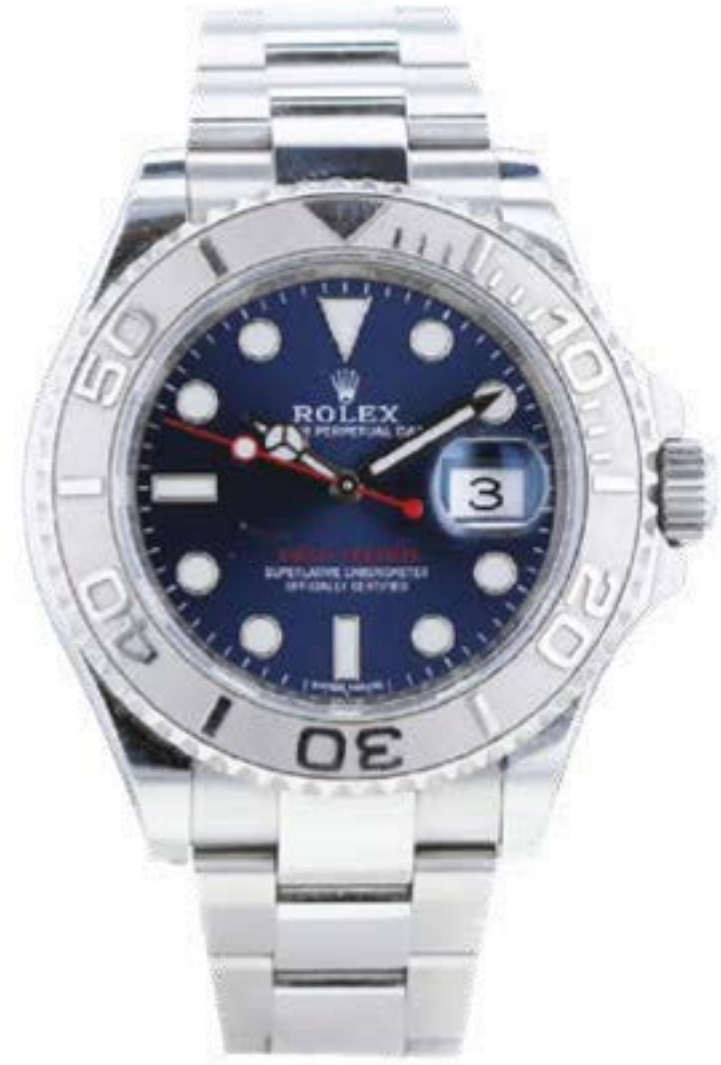

- ACERO
- 40 MM
- AUTOMÁTICO

\$13,000



116622
REFERENCIA

YACHT-MASTER



- ACERO
- 40 MM
- AUTOMÁTICO

\$9,800



16622
REFERENCIA

YACHT-MASTER



- ORO
- 44 MM
- AUTOMÁTICO

\$44,500

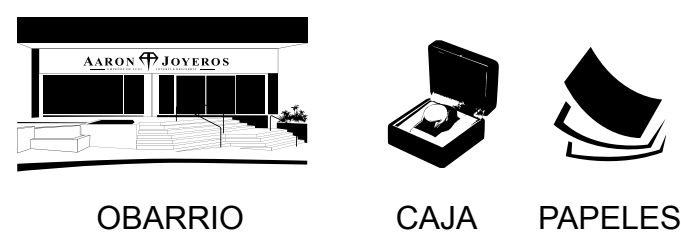

116688
REFERENCIA

YACHT-MASTER



- ACERO
- 40 MM
- AUTOMÁTICO

\$12,500

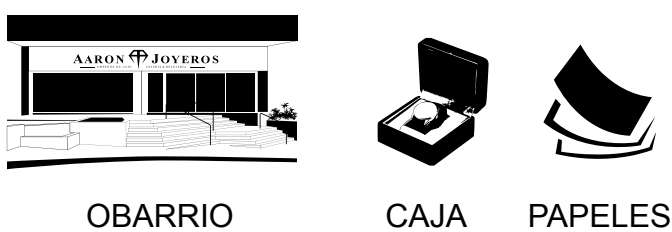

16622
REFERENCIA

YACHT-MASTER



- ACERO / ORO ROSA
- 44 MM
- AUTOMÁTICO

\$23,000



116681
REFERENCIA

AIR KING

DAYTONA

DATEJUST

DAY-DATE

EXPLORER

GMT-MASTER

MILGAUSS

OYSTER PERP.

SEA-DWELLER

SKY-DWELLER

SUBMARINER

YACHT-MASTER

YACHT-MASTER



- ACERO / ORO
- 40 MM
- AUTOMÁTICO

\$13,500



OBARRIO

16623

REFERENCIA

YACHT-MASTER

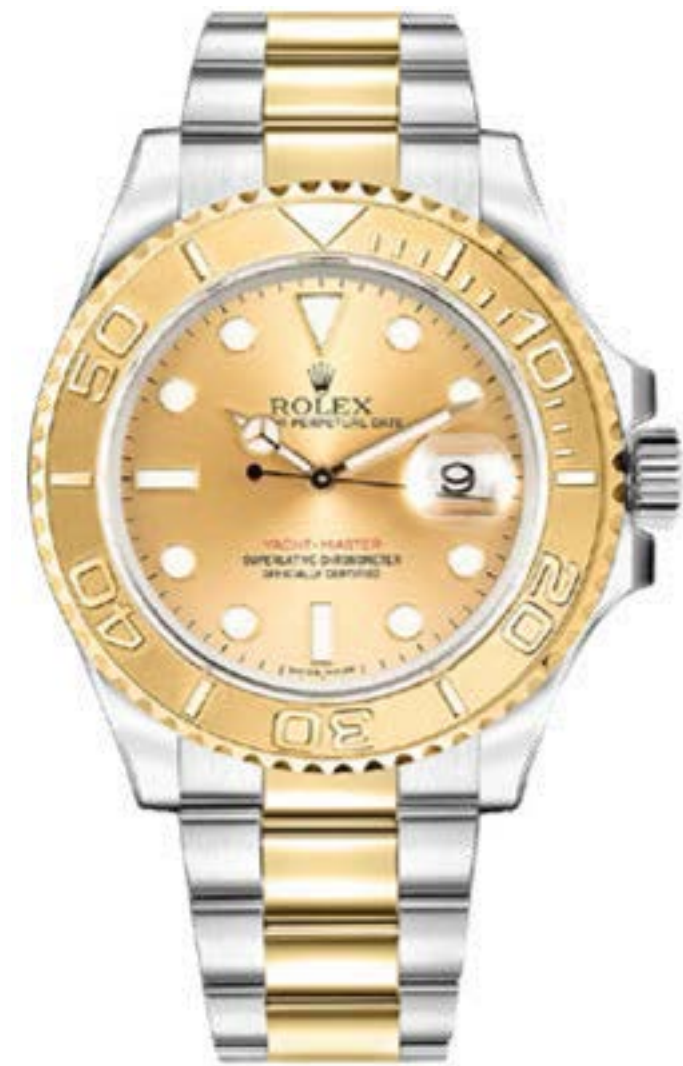

- ACERO / ORO
- 40 MM
- AUTOMÁTICO

\$13,800



COSTA DEL ESTE



CAJA

16623

REFERENCIA

YACHT-MASTER



"SERTI DIAL"

- ORO
- 40 MM
- AUTOMÁTICO

\$28,000



OBARRIO

16628

REFERENCIA

YACHT-MASTER



"SERTI DIAL"

- ORO
- 40 MM
- AUTOMÁTICO

\$20,000



COSTA DEL ESTE

168628

REFERENCIA

AIR KING	DAYTONA	DATEJUST	DAY-DATE	EXPLORER	GMT-MASTER
MILGAUSS	OYSTER PERP.	SEA-DWELLER	SKY-DWELLER	SUBMARINER	YACHT-MASTER

YACHT-MASTER



- ACERO / ORO ROSA
- 44 MM
- AUTOMÁTICO

\$24,500

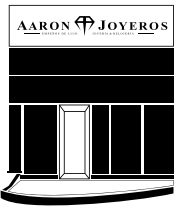

COSTA DEL ESTE

116681

REFERENCIA

YACHT-MASTER



- ACERO / ORO ROSA
- 44 MM
- AUTOMÁTICO

\$22,500



OBARRIO

116681

REFERENCIA

YACHT-MASTER



- ACERO / ORO ROSA
- 44 MM
- AUTOMÁTICO

\$22,500



OBARRIO

116681

REFERENCIA

YACHT-MASTER
"CANAL DE PANAMÁ"

"EDICIÓN LIMITADA" 150 PIEZAS



- ACERO
- 44 MM
- AUTOMÁTICO

\$25,000

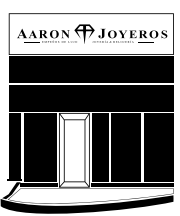

COSTA DEL ESTE

116680

REFERENCIA

YACHT-MASTER
"CANAL DE PANAMÁ"

"EDICIÓN LIMITADA" 150 PIEZAS

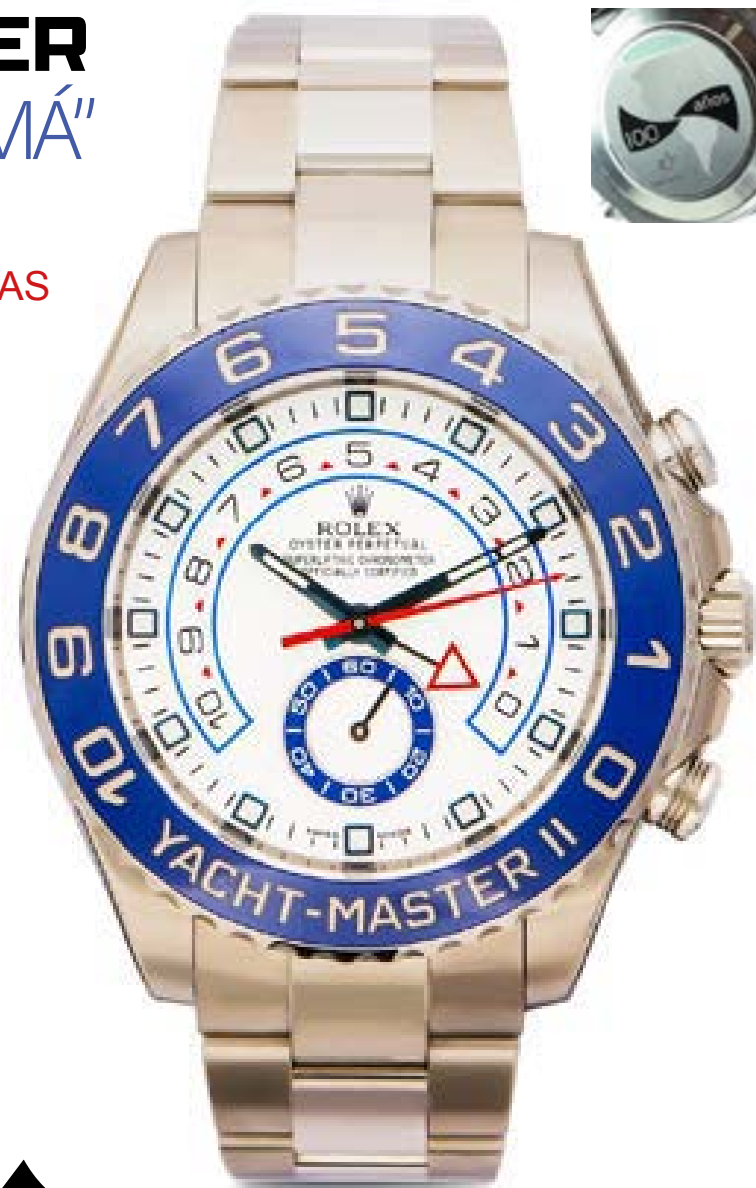

- ACERO
- 44 MM
- AUTOMÁTICO

\$23,500



OBARRIO



CAJA



PAPELES

116680

REFERENCIA

- AIR KING
- DAYTONA
- DATEJUST
- DAY-DATE
- EXPLORER
- GMT-MASTER
- MILGAUSS
- OYSTER PERP.
- SEA-DWELLER
- SKY-DWELLER
- SUBMARINER
- YACHT-MASTER

YACHT-MASTER



- ACERO
- 44 MM
- AUTOMÁTICO

\$19,500

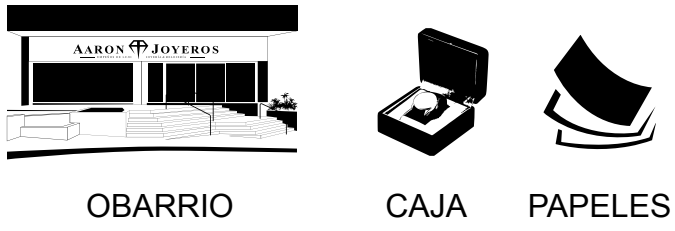

116680

REFERENCIA

YACHT-MASTER



- ACERO
- 44 MM
- AUTOMÁTICO

\$19,000



OBARRIO

116680

REFERENCIA

YACHT-MASTER



- ORO BLANCO
- 44 MM
- AUTOMÁTICO

\$36,000



116689

REFERENCIA

YACHT-MASTER



- ORO BLANCO
- 44 MM
- AUTOMÁTICO

\$38,000

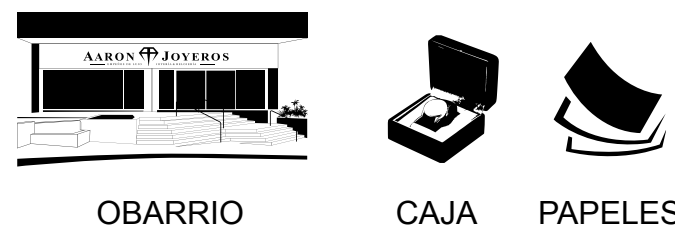

OBARRIO

CAJA PAPELES

116689

REFERENCIA

- AIR KING
- DAYTONA
- DATEJUST
- DAY-DATE
- EXPLORER
- GMT-MASTER
- MILGAUSS
- OYSTER PERP.
- SEA-DWELLER
- SKY-DWELLER
- SUBMARINER
- YACHT-MASTER

CELLINI
SERPICO Y LAINO

"VINTAGE"

- ORO
- 32 MM
- CUERDA MANUAL



\$5,000



OBARRIO

8940
REFERENCIA

CELLINI

- ORO BLANCO
- 39 MM
- CUERDA MANUAL



\$13,000



COSTA DEL ESTE

50509
REFERENCIA

CELLINI
GENEVE

- ACERO
- MM
- QUARTZ



\$16,500



OBARRIO

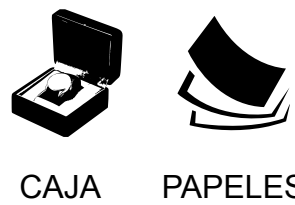

CAJA
PAPELES

6623
REFERENCIA

CELLINI

- ORO BLANCO
- 32 MM
- AUTOMÁTICO



\$5,500



OBARRIO

5116
REFERENCIA

CELLINI

- ORO
- 25 MM
- QUARTZ



\$20,000



OBARRIO

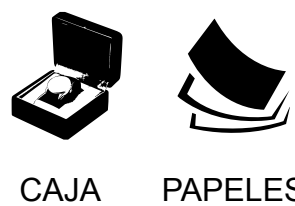

CAJA
PAPELES

5218
REFERENCIA

PRECISION
VINTAGE

- ACERO/ORO/DIAMANTES
- 26 MM
- QUARTZ



\$12,800



OBARRIO



CAJA

VINTAGE
REFERENCIA

AIR KING

DAYTONA

DATEJUST

DAY-DATE

EXPLORER

GMT-MASTER

MILGAUSS

OYSTER PERP.

SEA-DWELLER

SKY-DWELLER

SUBMARINER

YACHT-MASTER

ORCHID



ORO / DIAMANTES

19 X 24 MM

CUERDA MANUAL

\$8,200



OBARRIO



CAJA



PAPELES

ORCHID
REFERENCIA

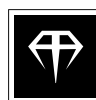



TAGHeuer

SWISS AVANT-GARDE SINCE 1860

TAG Heuer es una prestigiosa manufactura suiza reconocida por su innovación, precisión y estrecha relación con el automovilismo y el cronometraje deportivo. La firma se ha destacado por la creación de modelos icónicos como el Carrera, Monaco y Aquaracer, que combinan rendimiento técnico con un diseño deportivo y contemporáneo. Su enfoque une tecnología, fiabilidad y espíritu competitivo, representando dinamismo, excelencia y tradición dentro de la relojería suiza de lujo.

AARON  JOYEROS

— JOYERIA & RELOJERIA —



AQUARACER	CALIBRE	CARRERA	CHRONOMETER	FÓRMULA	LINK
MONZA	MÓNACO	MOP DIAMOND	PROFESSIONAL		

AQUARACER

- ACERO
- 43 MM
- AUTOMÁTICO

\$1,800



OBARRIO



CAK2110.BA0833
REFERENCIA

AQUARACER

- ACERO / ORO
- 43 MM
- AUTOMÁTICO

\$2,600



OBARRIO



WAJ2150
REFERENCIA

AQUARACER

- ACERO / ORO
- 27 MM
- AUTOMÁTICO

\$850



OBARRIO



WAF1420
REFERENCIA

AQUARACER

- ACERO / BAÑO DE ORO
- 27 MM
- QUARTZ

\$2,300



OBARRIO



WAF1320.BB0820
REFERENCIA

AQUARACER

- ACERO
- 43 MM
- QUARTZ

\$1,200



OBARRIO



CAY1110.BA0927
REFERENCIA

AQUARACER

- ACERO
- 35 MM
- QUARTZ

\$1,400



OBARRIO



WAY131H.BA0914
REFERENCIA



TAGHeuer
SWISS AVANT-GARDE SINCE 1860

 Índice

- AQUARACER
- CALIBRE
- CARRERA
- CHRONOMETER
- FÓRMULA
- LINK
- MONZA
- MÓNACO
- MOP DIAMOND
- PROFESSIONAL

SLR CALIBRE S



CAG7010_883497
REFERENCIA

 ACERO

 47 MM

 QUARTZ

\$1,500



OBARRIO





AQUARACER

CALIBRE

CARRERA

CHRONOMETER

FÓRMULA

LINK

MONZA

MÓNACO

MOP DIAMOND

PROFESSIONAL

CARRERA



- ACERO
- 39 MM
- AUTOMÁTICO

\$2,300



COSTA DEL ESTE



CAJA



PAPELES

WBN2112.BA0639

REFERENCIA

CARRERA TITAN



- TITANIO / ORO
- 45 MM
- AUTOMÁTICO

\$5,400



OBARRIO

REF. CAR2A5A.FT6044

REFERENCIA

CARRERA



- ACERO
- 41 MM
- AUTOMÁTICO

\$3,000



OBARRIO



CAJA



PAPELES

WBN2010

REFERENCIA

CARRERA



- ACERO / ORO
- 41 MM
- AUTOMÁTICO

\$3,000



OBARRIO

CV2050-1

REFERENCIA

CARRERA



- ACERO
- 41 MM
- AUTOMÁTICO

\$2,200



OBARRIO



PAPELES

WAR5010.BA0723

REFERENCIA

CARRERA CALIBRE 8 GMT



- ACERO
- 41 MM
- AUTOMÁTICO

\$2,300



OBARRIO

WAR5010.BA0723

REFERENCIA



AQUARACER

CALIBRE

CARRERA

CHRONOMETER

FÓRMULA

LINK

MONZA

MÓNACO

MOP DIAMOND

PROFESSIONAL

CARRERA

ACERO

43 MM

AUTOMÁTICO

\$3,200



OBARRIO



CAR2A80

REFERENCIA



GRAN CARRERA CALIBRE 17

ACERO

42.5 MM

AUTOMÁTICO

\$3,600



OBARRIO



CAV518B

REFERENCIA

CARRERA

ACERO

42 MM

AUTOMÁTICO

\$3,800



OBARRIO



OBN2010

REFERENCIA



CARRERA

ACERO

41 MM

AUTOMÁTICO

\$2,200



OBARRIO



WBN2013.FC6503

REFERENCIA





TAGHeuer
SWISS AVANT-GARDE SINCE 1860

 Índice

- AQUARACER
- CALIBRE
- CARRERA
- CHRONOMETER
- FÓRMULA
- LINK
- MONZA
- MÓNACO
- MOP DIAMOND
- PROFESSIONAL

CHRONOMETER



-  ACERO
-  38 MM
-  AUTOMÁTICO

\$900



OBARRIO

WH5115-KT
REFERENCIA





TAGHeuer
SWISS AVANT-GARDE SINCE 1860



Índice

AQUARACER

CALIBRE

CARRERA

CHRONOMETER

FÓRMULA

LINK

MONZA

MÓNACO

MOP DIAMOND

PROFESSIONAL

FÓRMULA 1



\$1,500



ACERO



38 MM



QUARTZ



CAJA



PAPELES



OBARRIO

AARON  JOYEROS



AQUARACER

CALIBRE

CARRERA

CHRONOMETER

FÓRMULA

LINK

MONZA

MÓNACO

MOP DIAMOND

PROFESSIONAL

FÓRMULA 1



ACERO

37 MM

QUARTZ

\$1,600



OBARRIO

WAC1215-0

REFERENCIA

FÓRMULA 1



ACERO

43 MM

QUARTZ

\$1,500



OBARRIO

CAZ101AN.FC8243

REFERENCIA

FÓRMULA 1



ACERO / CERÁMICA

41 MM

QUARTZ

\$1,400



OBARRIO

CAH1213

REFERENCIA

FÓRMULA 1



ACERO

41 MM

QUARTZ

\$1,300



OBARRIO



CAJA



PAPELES

CAH1111.BA0850

REFERENCIA

FÓRMULA 1 LADY



ACERO / DIAMANTES

37 MM

QUARTZ

\$2,500



OBARRIO



CAJA



PAPELES

WAU2213

REFERENCIA

FÓRMULA 1 DAVID GUETTA



ACERO

43 MM

AUTOMÁTICO

\$2,000



OBARRIO



CAJA

WAZ201A

REFERENCIA



AQUARACER

CALIBRE

CARRERA

CHRONOMETER

FÓRMULA

LINK

MONZA

MÓNACO

MOP DIAMOND

PROFESSIONAL

FÓRMULA 1 LADY



ACERO

43 MM

QUARTZ

\$2,100



OBARRIO

WAZ201A

REFERENCIA

FÓRMULA 1 LADY



ACERO

36 MM

QUARTZ

\$2,000



OBARRIO

WAC1216-0

REFERENCIA

FÓRMULA 1 SOLARGRAPH



ACERO

38 MM

QUARTZ

\$2,700



OBARRIO



CAJA

WBY111B.BA0042

REFERENCIA



- AQUARACER
- CALIBRE
- CARRERA
- CHRONOMETER
- FÓRMULA
- LINK
- MONZA
- MÓNACO
- MOP DIAMOND
- PROFESSIONAL

LINK CALIBRE



T2011.BA0951
REFERENCIA

- ACERO
- 42 MM
- AUTOMÁTICO

\$1,500



OBARRIO

LINK



0000

REFERENCIA

- ACERO
- 40 MM
- AUTOMÁTICO

\$1,200



OBARRIO





- AQUARACER
- CALIBRE
- CARRERA
- CHRONOMETER
- FÓRMULA
- LINK
- MONZA
- MÓNACO
- MOP DIAMOND
- PROFESSIONAL

MONZA CALIBRE 17



 ACERO / CERÁMICA

 42 MM

 AUTOMÁTICO

\$4,000



OBARRIO

CR2080

REFERENCIA





- AQUARACER
- CALIBRE
- CARRERA
- CHRONOMETER
- FÓRMULA
- LINK
- MONZA
- MÓNACO
- MOP DIAMOND
- PROFESSIONAL

MÓNACO



- ACERO
- 41 MM
- AUTOMÁTICO

\$4,200



OBARRIO

WW2114

REFERENCIA

MÓNACO



- ACERO
- 38MM
- AUTOMÁTICO

\$3,200



OBARRIO

CW2112.FC6171

REFERENCIA





AQUARACER

CALIBRE

CARRERA

CHRONOMETER

FÓRMULA

LINK

MONZA

MÓNACO

MOP DIAMOND

PROFESSIONAL

MOP DIAMOND

“DIAL MADRE PERLA”

 ACERO

 28 MM

 QUARTZ

\$1,200



OBARRIO

WP131C

REFERENCIA





AQUARACER

CALIBRE

CARRERA

CHRONOMETER

FÓRMULA

LINK

MONZA

MÓNACO

MOP DIAMOND

PROFESSIONAL

PROFESSIONAL



ACERO

37 MM

QUARTZ

\$600



OBARRIO

WL1112.BA0701

REFERENCIA

PROFESSIONAL



ACERO

37 MM

QUARTZ

\$950



OBARRIO

WK1112

REFERENCIA

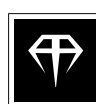

TIFFANY & Co.

Tiffany & Co. es una prestigiosa casa de lujo reconocida por su excelencia en joyería y su refinada propuesta dentro del universo de la relojería. La firma se ha destacado por crear relojes que combinan elegancia atemporal, diseño sofisticado y una meticulosa atención al detalle, reflejando su legado de artesanía y exclusividad. Su enfoque une tradición, innovación y estilo, representando distinción, lujo y excelencia dentro de la relojería contemporánea.

AARON  **JOYEROS**

— JOYERIA & RELOJERIA —

ATLAS DOME

 ACERO

 31 MM

 QUARTZ

\$1,500



Z1831.11.10B10A40A
REFERENCIA



OBARRIO

CLASSIC

 ORO

 35 MM

 AUTOMÁTICO

\$5,000



M253
REFERENCIA



OBARRIO



T+
TISSOT



Tissot es una histórica manufactura suiza reconocida por su precisión, innovación y amplia tradición relojera. La firma se ha destacado por desarrollar relojes que combinan tecnología, fiabilidad y diseño versátil, además de su estrecha vinculación con el cronometraje deportivo internacional. Su enfoque une calidad, accesibilidad y excelencia técnica, representando tradición, rendimiento y prestigio dentro de la relojería suiza contemporánea.

AARON  **JOYEROS**

— JOYERIA & RELOJERIA —

PRS 516



-  ACERO
-  42 MM
-  AUTOMÁTICO

\$950



OBARRIO





CAJA

T100.430.16.051.00
REFERENCIA

T-RACE
NICKY HAYDEN

“EDICIÓN LIMITADA”



-  ACERO
-  42 MM
-  AUTOMÁTICO

\$300



OBARRIO

T90487682
REFERENCIA





TUDOR

Tudor es una prestigiosa manufactura suiza reconocida por su robustez, precisión y sólida herencia dentro de la relojería de lujo. La firma se ha destacado por desarrollar relojes deportivos de alto rendimiento, con modelos icónicos como el Black Bay y el Pelagos, que combinan innovación técnica con un diseño funcional y atemporal. Su enfoque une fiabilidad, tradición y espíritu aventurero, representando excelencia, carácter y rendimiento dentro de la relojería suiza contemporánea.

AARON  JOYEROS

— JOYERIA & RELOJERIA —

TUDOR

BLACK BAY



ACERO / CERÁMICA

41 MM

AUTOMÁTICO

\$3,850



OBARRIO



CAJA



PAPELES

M79210CNU-0001

REFERENCIA

DOUBLE DATE



ACERO

42 MM

AUTOMÁTICO

\$3,000



OBARRIO



CAJA



PAPELES

M57100-0001

REFERENCIA

CLAIR DE ROSE



ACERO

30 MM

AUTOMÁTICO

\$2,200



OBARRIO

35701

REFERENCIA

U-BOAT

U-Boat es una distintiva firma italiana de relojería reconocida por su diseño audaz, grandes dimensiones y fuerte inspiración militar. La marca se ha destacado por crear relojes de gran presencia, caracterizados por cajas robustas, excelente legibilidad y soluciones técnicas originales que reflejan una identidad inconfundible. Su enfoque combina innovación, funcionalidad y carácter, representando exclusividad, personalidad y estilo contemporáneo dentro de la relojería de lujo.

AARON  **JOYEROS**

— JOYERIA & RELOJERIA —

CLASSICO

 ACERO

 53 MM

 AUTOMÁTICO

\$1,800



OBARRIO



55780

REFERENCIA





Ulysse Nardin es una prestigiosa manufactura suiza reconocida por su innovación, excelencia mecánica y profunda tradición en la relojería de precisión. La firma se ha destacado por desarrollar complicaciones de alta gama y cronómetros marinos de referencia, combinando ingeniería avanzada con un diseño refinado y contemporáneo. Su enfoque une herencia, tecnología y artesanía, representando exclusividad, rendimiento y vanguardia dentro del universo de la alta relojería.



MAXI MARINE



ACERO



41 MM



AUTOMÁTICO

\$3,800

353-66-314

REFERENCIA





OBARRIO



MARINE



-  ACERO
-  40 MM
-  AUTOMÁTICO

\$4,000



OBARRIO





CAJA

263-33

REFERENCIA

DIVER



-  ACERO
-  40 MM
-  AUTOMÁTICO

\$7,000



OBARRIO



CAJA





PAPELES

1183-170-3/92

REFERENCIA

SAN MARCO



-  ACERO
-  38.5 MM
-  AUTOMÁTICO

\$3,000



OBARRIO

433-77

REFERENCIA



VACHERON CONSTANTIN
GENÈVE

Ulysse Nardin es una prestigiosa manufactura suiza reconocida por su innovación, excelencia mecánica y profunda tradición en la relojería de precisión. La firma se ha destacado por desarrollar complicaciones de alta gama y cronómetros marinos de referencia, combinando ingeniería avanzada con un diseño refinado y contemporáneo. Su enfoque une herencia, tecnología y artesanía, representando exclusividad, rendimiento y vanguardia dentro del universo de la alta relojería.

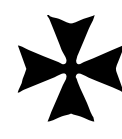

VACHERON CONSTANTIN
GENÈVE

índice

MARINE



2042/000J-8966
REFERENCIA

- ORO
- 37 MM
- AUTOMÁTICO

\$18,000



OBARRIO



Van Cleef & Arpels

Van Cleef & Arpels es una prestigiosa maison francesa reconocida por su excelencia en alta joyería y su refinada interpretación de la alta relojería. La firma se ha destacado por crear relojes que combinan complicaciones mecánicas con un extraordinario sentido artístico, integrando piedras preciosas, oficios decorativos y diseños inspirados en la naturaleza y la poesía. Su enfoque une creatividad, artesanía y exclusividad, representando elegancia, sofisticación y excelencia dentro del universo del lujo.

AARON  **JOYEROS**

— JOYERIA & RELOJERIA —

CÁRDENAS



 ORO

 26 X 14 MM

 AUTOMÁTICO

\$9,700

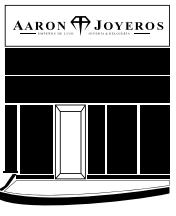

COSTA DEL ESTE

371505

REFERENCIA



Vintage

La colección Vintage rinde homenaje a la época dorada de la relojería, cuando la precisión mecánica y la excelencia artesanal dieron vida a piezas destinadas a perdurar. Estos relojes destacan por su manufactura tradicional, el uso de metales nobles y esferas de exquisita factura, reflejando el refinamiento de otra era. Cada ejemplar conserva un legado de historia, ingeniería y elegancia atemporal, representando exclusividad, sofisticación y el valor perdurable de la auténtica relojería clásica.

AARON  **JOYEROS**

— JOYERIA & RELOJERIA —

Vintage

WALTHAM

VINTAGE

Colección personal de Juan Vicente Gómez, representa la unión entre la precisión industrial y el poder político de principios del siglo XX. Con su esfera de porcelana blanca y caja de alta gama, esta pieza personifica la estética de sobriedad y mando que caracterizó al "Benemérito". Más que un instrumento para medir el tiempo, el ejemplar es un testigo patrimonial de la historia venezolana y de la fiabilidad técnica de una era dorada en la relojería norteamericana.

ORO 18k



48 mm



Cuerda manual

PRECIO

\$20,000



OBARRIO



REF.

VINTAGE

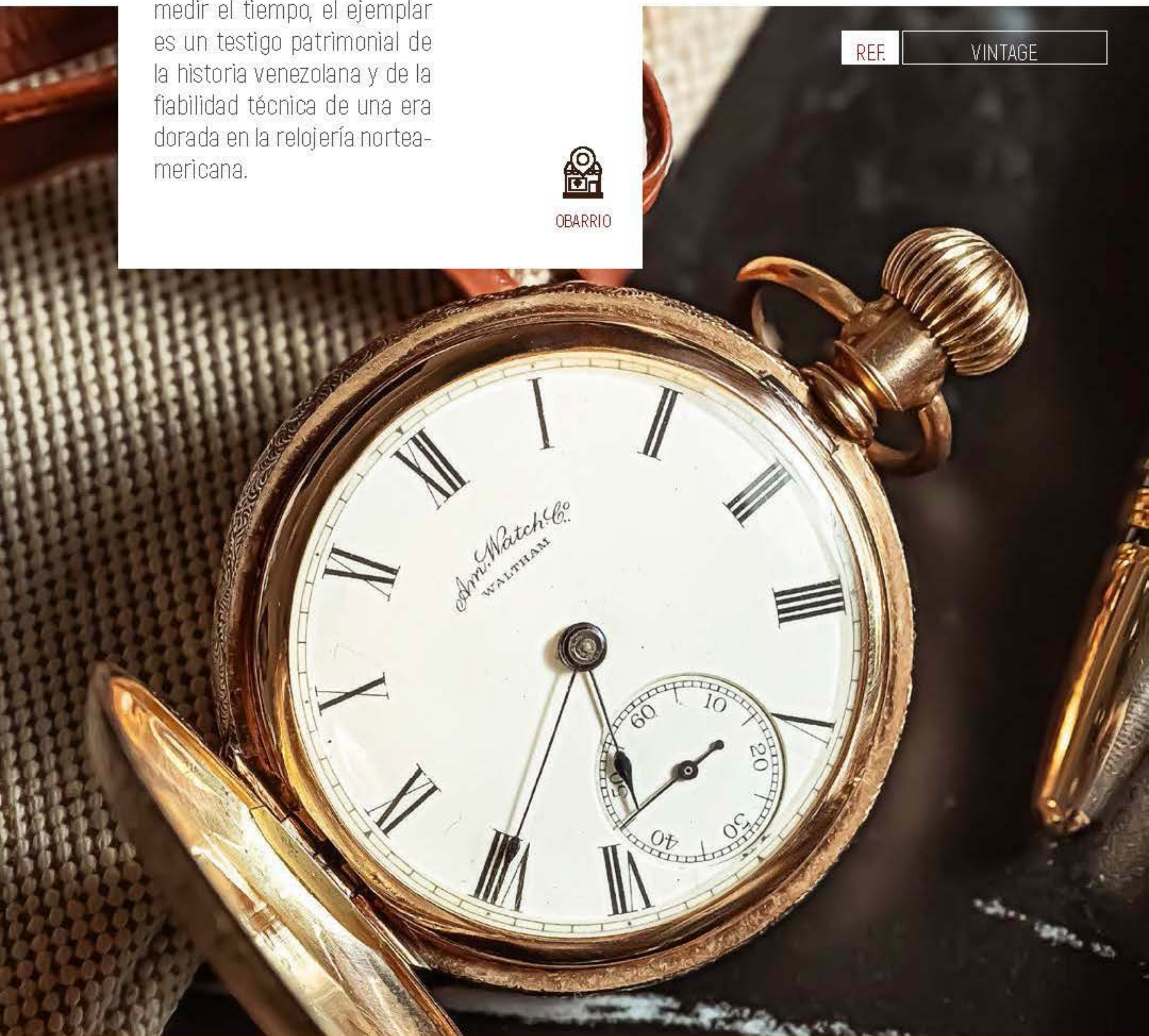

OMEGA



-  ACERO
-  27.5 MM
-  QUARTZ

\$1,500





OBARRIO

VINTAGE
REFERENCIA

TUDOR

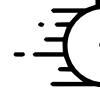

-  ACERO
-  17 MM
-  AUTOMÁTICO

\$800



OBARRIO

VINTAGE
REFERENCIA

PRECISION VINTAGE

ACERO / ORO / DIAMANTES



-  ACERO
-  16 MM
-  QUARTZ

\$12,800



OBARRIO





CAJA

VINTAGE
REFERENCIA

OMEGA VINTAGE

"STRAP AFTER MARKET"



-  ORO ROSA
-  36 MM
-  AUTOMÁTICO

\$4,000



OBARRIO

VINTAGE
REFERENCIA

OMEGA CONSTELLATION



-  ACERO
-  35 MM
-  QUARTZ

\$4,000





OBARRIO

2652 SC
REFERENCIA

SEAMASTER DYNAMIC

"BISEL ORO"



-  ACERO
-  34 MM
-  QUARTZ

\$1,000



OBARRIO

196.0301 396.0993
REFERENCIA

PIAGET CUERVOS Y SOBRINOS



- ACERO
- 32 MM
- AUTOMÁTICO

\$500



OBARRIO

0000

REFERENCIA

LONGINES



- ORO
- 32 MM
- QUARTZ

\$3,500



OBARRIO



CAJA

1940

REFERENCIA

SEAMASTER VINTAGE



- ORO
- 34 MM
- QUARTZ

\$1,900



OBARRIO

VINTAGE

REFERENCIA

SEAMASTER 1970

"DIAL SPIDER"



- ACERO
- 43 X 46 MM
- AUTOMÁTICO

\$9,000



OBARRIO

166.073

REFERENCIA

MUST VERMEIL 925



- ORO
- 24 MM
- QUARTZ

\$1,900



OBARRIO

590004

REFERENCIA

Diamantes



Presentamos una cuidada selección de diamantes elegidos bajo los más altos estándares de calidad, pureza y proporción. Cada piedra ha sido evaluada por su brillo, simetría y transparencia, garantizando una presencia que deslumbra a primera vista.

Nuestra colección equilibra corte, color, claridad y quilataje, asegurando no solo belleza excepcional, sino también valor y permanencia en el tiempo. Más que una muestra de gemas, es una invitación a invertir con criterio y crear piezas destinadas a trascender generaciones.

Aquí comienza su próxima gran elección.



DIAMANTES

01/02



REDONDO

CT 1.06
COLOR J/K
CLARIDAD VS2

PRECIO 
\$4,150

OBARRIO



REDONDO

CT 0.44
COLOR K/L
CLARIDAD SI1

PRECIO 
\$650

OBARRIO



REDONDO

CT 0.22
COLOR
CLARIDAD

PRECIO 
\$2,000

OBARRIO



REDONDO

 **GIA** 
CT 1.30 L, FAINT
COLOR BROWN
CLARIDAD VVS2

PRECIO 
\$3,300

OBARRIO



REDONDO

CT 1.20
COLOR
CLARIDAD

PRECIO 
\$3,800

OBARRIO



PRINCESS CUT

CT 1.60
COLOR H
CLARIDAD I2

PRECIO 
\$5,000

OBARRIO



DIAMANTES

02/02



REDONDO

CT 1.64
COLOR G
CLARIDAD VS2

PRECIO 
\$12,000

OBARRIO



RADIANT CUT



CT 2.19
COLOR F
CLARIDAD wvs1

PRECIO 
\$22,000

OBARRIO



REDONDO

CT 0.75
COLOR J
CLARIDAD VS11

PRECIO 
\$2,500

OBARRIO



REDONDO

CT 1.735
COLOR m
CLARIDAD s11

PRECIO 
\$3,500

OBARRIO



CUSHION CUT

CT 0.87
COLOR fancy
CLARIDAD yellow

PRECIO 
\$4,500

OBARRIO



CUSHION CUT



CT 2.13
COLOR f
CLARIDAD vs1

PRECIO 
\$19,800

COSTA DEL ESTE



BOLÍGRAFOS

Una colección creada para quienes ven la escritura como una **expresión de estilo y personalidad**. Cada pieza combina precisión, equilibrio y diseño refinado para ofrecer una experiencia superior en cada trazo.



AARON  JOYEROS

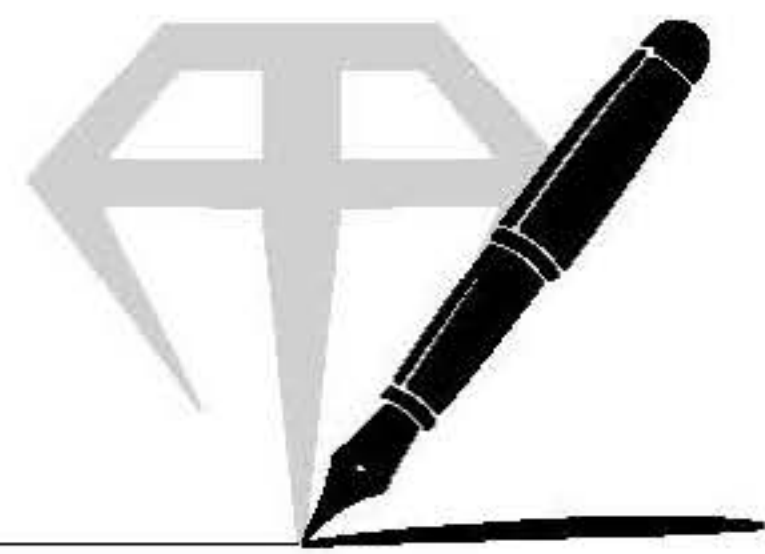

BOLÍGRAFOS

HOMENAJE A

ROBERT LOUIS STEVENSON



MONTBLANC

EDICIÓN LIMITADA



CAJA



PAPELES

Este exclusivo bolígrafo, inspirado en el espíritu aventurero y literario de Robert Louis Stevenson, combina elegancia clásica con detalles náuticos y artesanales. Su acabado en tonos dorados, grabados refinados y elementos inspirados en la exploración reflejan la esencia del autor de **La Isla del Tesoro**. Una pieza de colección que une escritura, historia y lujo en un diseño sofisticado y atemporal.

PRECIO 
\$5,700



AARON  JOYEROS

BOLÍGRAFOS



**MONT
BLANC**



JOHN LENNON

TIPO | ROLLERBALL

PRECIO 
\$1,400



JOHN LENNON

TIPO | FUENTE

PRECIO 
\$1,400





OBARRIO

 índice

MONT 
BLANC



MAHATMA GANDHI

TIPO | ESTILOGRÁFICA



CAJA



PAPELES

\$2,200



AARON  JOYEROS

BOLÍGRAFOS



**MONT
BLANC**

HENRY E. STEINWAY

TIPO | ESTILOGRÁFICA



Mecenas del Arte
Steinway 4810

Esta pluma rinde homenaje a Henry E. Steinway, fundador de Steinway & Sons y revolucionario de la fabricación de pianos en el siglo XIX. Montblanc la incluyó en su colección Patron of Art, combinando inspiración musical con alta artesanía en escritura.



PAPELESCAJA

PRECIO 
\$3,000



AARON  **JOYEROS**

BOLÍGRAFOS



EDITION
LEO TOLSTOY

TIPO | BALLPOINT

PRECIO 
\$3,500



CAJA

EDITION LEO
TOLSTOY **TIPO** |
BALLPOINT

PRECIO
\$2,600



PAPELES

MONT 
BLANC



AARON  **JOYEROS**

BOLÍGRAFOS



**MONT
BLANC** 

GEORGE BERNARD SHAW

EDICIÓN LIMITADA

TIPO | BALLPOINT



PAPELESCAJA



PRECIO 
\$1,500



EDICIÓN MEISTERSTÜCK

TIPO | ROLLERBALL

PRECIO 
\$700



AARON  JOYEROS

BOLÍGRAFOS



**MONT
BLANC** 



MEISTERSTÜCK

TIPO | BALLPOINT

PRECIO 
\$300

MEISTERSTÜCK

TIPO | RESALTADOR 

PRECIO 
\$220

CAJA



AARON  JOYEROS

BOLÍGRAFOS



**MONT
BLANC**



STARWALKER

TIPO | ESTILIGRÁFICA

PRECIO 
\$300



MEISTERSTÜCK

TIPO | BALLPOINT

PRECIO 
\$400



MEISTERSTÜCK

TIPO | BALLPOINT Solitaire Douè

PRECIO 
\$1,400



AARON  JOYEROS

BOLÍGRAFOS



Cartier

LE MUST PHANTERE

TIPO | ESTILIGRÁFICA

PRECIO 
\$1,200



DIABOLO

Cartier

TIPO | BALLPOINT

PRECIO 
\$600



**MONT
BLANC** 

TIPO
Bohème
Rollerball

PRECIO 
\$650



WATERMAN
PARIS

TIPO
EDSON
FUENTE

PRECIO 
\$120



 **PILOT**

TIPO
BLACK
CARBONESQUE
FUENTE

PRECIO 
\$120



AARON  **JOYEROS**

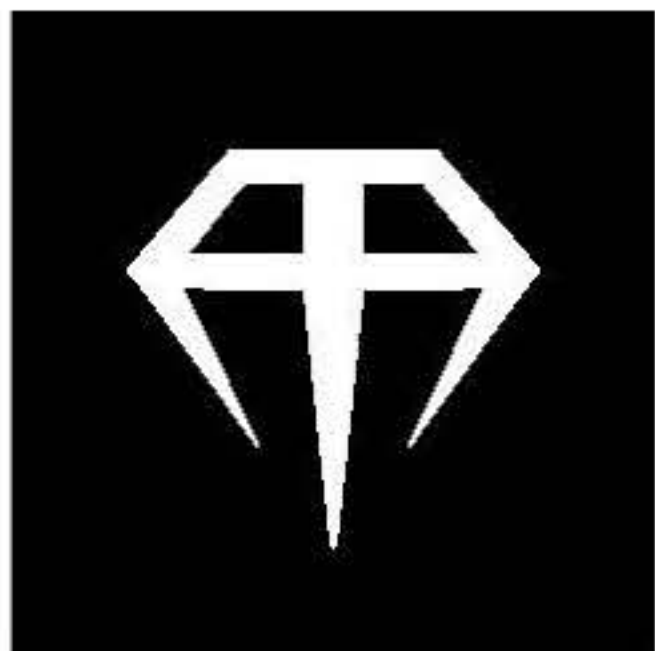

Mancuernas

01

Clásicos Atemporales

Siluetas pulidas y simétricas que celebran el buen vestir tradicional. La inversión definitiva en sutileza y distinción que nunca pasa de moda.

TIFFANY & Co.

ESPECIFICACIONES



Oro / 18 Quilates



OBARRIO

PRECIO

\$2,420



ESPECIFICACIONES



Oro / 14 Quilates



OBARRIO

PRECIO

\$3,100

ESPECIFICACIONES



Oro / 14 Quilates



OBARRIO

PRECIO

\$3,000



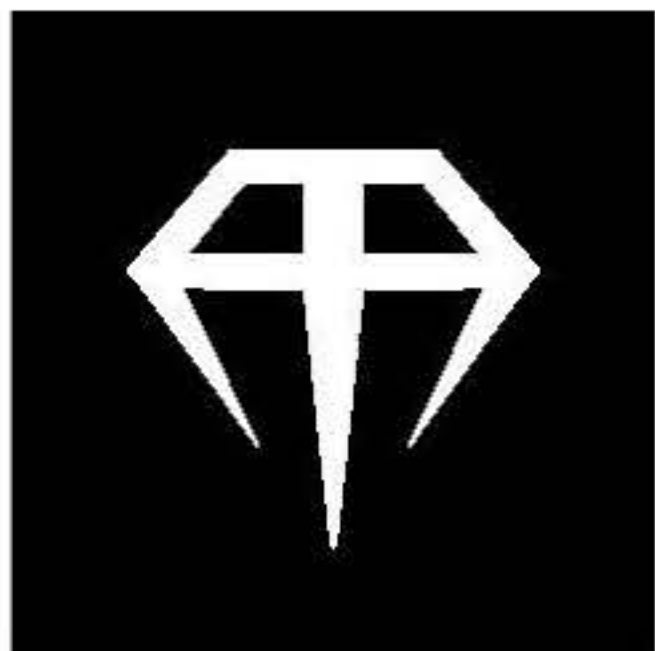

Mancuernas

02

Ingeniería de Precisión

Piezas que fusionan la micro-ingeniería con la alta joyería. Un homenaje al diseño estructural para quienes ven el detalle técnico como una forma de arte.



BREITLING
1884

ESPECIFICACIONES



Acero



OBARRIO

PRECIO

\$120

ESPECIFICACIONES



Oro Rosa / 18 Quilates



OBARRIO

PRECIO

\$3,000



Cartier

ESPECIFICACIONES



Acero



OBARRIO

PRECIO

\$500

